



Republic of Uganda

Ministry of Water and Environment

Electricity Access Scale-Up Project (EASP)

Project ID: P166685

Supply, Installation and Commissioning of 40 Solar Photovoltaic (PV) Energy Packages for Water Supply Schemes

Lot 1: Supply, Installation and Commissioning of 10 Solar Photovoltaic (PV) Energy Packages for Water Supply Schemes in Kiwenda, Kikyusa, Bamunanika, Banda, Ssekanyonyi, Mayanga, Kayunga, Buyende-2, Kagulu and Kasambira

Procurement Reference No: MWE/SUPLS/23-24/00007/1

VOLUME 4 – TECHNICAL SPECIFICATIONS

Date of Issue: November 2023

Contents

1	GENERAL INTRODUCTION.....	5
1.1	DOCUMENTATION INCLUDED	5
1.2	SCOPE OF GENERAL SPECIFICATIONS	5
1.2.1	<i>Scope of Technical specifications</i>	5
1.2.2	<i>Supply, delivery and installation</i>	5
1.2.3	<i>Additional equipment to be supplied</i>	6
1.2.4	<i>Electrical works</i>	6
1.2.5	<i>Civil and Plumbing works</i>	6
2	GENERAL TECHNICAL SPECIFICATIONS.....	7
2.1	STANDARDS	ERROR! BOOKMARK NOT DEFINED.
2.2	DESIGN AND STANDARDIZATION.....	7
2.3	SYSTEM DESIGN PARAMETERS AND CONFIGURATIONS	9
2.4	SYSTEM CONTROL	10
2.5	GALVANIZING	10
2.6	STEEL, ALUMINUM AND ALLOYS	11
2.7	LABELS.....	11
2.8	BOLTS AND NUTS.....	11
2.9	CLEANING AND PAINTING	11
2.10	CORONA AND RADIO INTERFERENCE	11
2.11	DRAWINGS	12
2.12	TYPE TESTS AND SYSTEM FUNCTIONAL GUARANTEE TESTS	12
2.13	SPARE PARTS	13
2.14	ERECTION MARKS	13
2.15	PACKING OF MATERIAL	13
2.16	INSTALLATION AND COMMISSIONING	14
2.16.1	<i>General requirements</i>	14
2.16.2	<i>System Installation</i>	14
2.16.3	<i>System commissioning</i>	14
2.17	OPERATION AND MAINTENANCE	15
2.18	OPERATION, MAINTENANCE AND REPAIR MANUALS	15
2.19	FAULT-FINDING AND USER FRIENDLINESS	15
2.20	SITE TREATMENT, LAND AND ENVIRONMENT.....	16
2.20.1	<i>Entry onto the Sites</i>	16
2.20.2	<i>Survey of Properties, Lands and environment</i>	16
2.20.3	<i>Site Fencing</i>	16
2.20.4	<i>Interference with Land Interests</i>	16
2.20.5	<i>Interference with Access to Properties</i>	17
2.21	CONCRETE WORKS	17
2.21.1	<i>General</i>	17
2.21.2	<i>Materials</i>	17
2.21.3	<i>Cement</i>	17
2.21.4	<i>Water</i>	18
2.21.5	<i>Sand and Coarse Aggregate</i>	18
2.21.6	<i>Composition of concrete</i>	18
2.21.7	<i>Concrete Mixes</i>	18
2.21.8	<i>Reinforcement and Binding Wire</i>	19
2.21.9	<i>Mortar</i>	20
2.21.10	<i>Surface Finishes</i>	20
2.21.11	<i>Treatment of Concrete</i>	21
2.21.12	<i>Grounding and Lightning Protection</i>	22
2.21.13	<i>Measurement and Payment</i>	22
2.22	GUARANTEE AND WARRANTY REQUIREMENTS	23

2.23	ENERGY PACKAGE CONTENTS AND ANCILLARY WORKS	23
2.23.1	Contents of the Energy package for a water-pumping scheme	23
2.23.2	Ancillary works	23
3	TECHNICAL SPECIFICATIONS OF ENERGY PACKAGE COMPONENTS	25
3.1	SOLAR-PV SYSTEM SPECIFICATIONS	25
3.1.1	General introduction.....	25
3.1.2	General specifications for SPV plants.....	25
3.1.3	General definitions.....	26
3.1.4	Abbreviations	28
3.1.5	Site Conditions and Meteorological Data.....	28
3.1.6	Specifications of Solar-PV Modules, Panels and Array.....	29
3.1.7	PV Module Installation and Accessories.....	32
3.1.8	Module or Array Mounting.....	33
3.1.9	Installation of Array Structure	35
3.2	SPECIFICATIONS OF PUMPS FOR WATER ABSTRACTION	38
3.2.1	Ground Water Pumps	38
3.2.2	Surface Water Pumps.....	38
3.2.3	Motor end.....	38
3.2.4	Pump end.....	38
3.3	SPECIFICATIONS OF POWER INVERTER AND PUMP DRIVE FOR SOLAR-PV WATER PUMPING APPLICATIONS	39
3.3.1	Inverter manufacture.....	39
3.3.2	Nature of system control unit.....	40
3.3.3	Input-Output Voltage capacity	40
3.3.4	The Inverter unit.....	40
3.4	GROUNDING AND LIGHTNING SURGE PROTECTION	41
3.4.1	Grounding and bonding.....	41
3.4.2	Earth connection.....	41
3.4.3	Grounding the pump.....	42
3.4.4	Lightning Protection.....	43
3.4.5	Surge protection	43
3.5	OTHER BALANCE OF SYSTEM EQUIPMENT	43
3.5.1	Wellhead assembly for borehole wells.....	43
3.5.2	Automatic Control for Full-tank shutoff.....	44
3.5.3	Well Probe for dry run protection.....	44
3.5.4	Draw Pipe.....	45
3.5.5	Sand Shroud.....	45
3.6	AUXILIARY LIGHTING SYSTEM	45
3.6.1	Auxiliary Lighting System Capacity.....	45
3.6.2	General requirements	45
3.6.3	Photovoltaic Modules.....	46
3.6.4	Solar (PV) array disconnect switch.....	46
3.6.5	Power Controller/Regulators.....	46
3.6.6	Battery.....	47
3.6.7	Interior and Exterior Luminaires	48
3.6.8	System installation.....	49
3.6.9	The DC-AC inverter.....	49
3.6.10	AC System Specifications.....	50
3.7	THE ALARM AND INTRUSION DETECTION SYSTEM.....	51
3.7.1	General requirements	51
3.7.2	Specific technical requirements.....	51
3.7.3	System Installation	51
3.8	SPECIFICATIONS FOR METALS, PLASTICS AND CONCRETE USED FOR WATER TANK, TANK STAND AND ASSOCIATED PLUMBING WORKS	52
3.8.1	Requirements.....	52

3.8.2	References, Codes and Standards.....	52
3.8.3	Quality Assurance.....	55
3.9	SPECIFICATIONS FOR TANK PARTS, METAL SUPPORT AND PLUMBING ACCESSORIES.....	56
3.9.1	General.....	56
3.9.2	Manufacturer.....	56
3.9.3	Polyethylene Storage Tanks.....	56
3.9.4	Tank Accessories.....	56
3.9.5	Level Indication.....	57
3.9.6	Factory Testing.....	57
3.9.7	Supply and Erection Elevated Tanks.....	57
3.9.8	Delivery, Storage, And Handling.....	59
3.10	REMOTE SENSING AND MONITORING SYSTEM.....	59
3.10.1	General.....	59
3.10.2	Remote Control.....	60
3.10.3	Remote Monitoring System Components.....	60
3.10.4	Remote Sensing and Monitoring Tools.....	60
3.10.5	Well Probe.....	60
3.10.6	Water Meter.....	61
3.10.7	Level Sensor.....	61
3.10.8	Pressure Sensor.....	61
3.10.9	Sun Sensor.....	61
3.10.10	Battery.....	62
3.10.11	LC20- solar module.....	62
3.10.12	Communication Technology.....	62
3.10.13	GSM-Based Far Distance Remote Access.....	63
SECTION IV: SPECIFICATIONS OF ENERGY PACKAGES FOR WATER SCHEMES.....		66
4	ENERGY PACKAGES SPECIFICATIONS FOR WATER SUPPLY SYSTEMS.....	68
4.1	WATER PUMPING REQUIREMENTS AND SYSTEM CONFIGURATION.....	68
4.1.1	Water Pumping Requirements.....	68
4.1.2	Solar Irradiance Data.....	68
4.1.3	Energy Package Design Packages.....	1
4.2	BAMUNANIKA WATER SUPPLY SYSTEM.....	1
4.2.1	Energy System Specifications for Bamunanika Water Supply System.....	1
4.2.2	Design summary for Bamunanika Energy Package.....	3
4.3	BANDA WATER SUPPLY SYSTEM.....	4
4.3.1	Energy System Specifications for Banda Water Supply System.....	4
4.3.2	Design summary for Banda Energy Package.....	6
4.4	KAYUNGA WATER SUPPLY SYSTEM.....	7
4.4.1	Energy System Specifications for Kayunga Water Supply System.....	7
4.4.2	Design summary for Kayunga Energy Package.....	9
4.5	KIKYUSA WATER SUPPLY SYSTEM.....	10
4.5.1	Energy System Specifications for Kikyusa Water Supply System.....	10
4.5.2	Design summary for Kikyusa Energy Package.....	12
4.6	KIWENDA WATER SUPPLY SYSTEM.....	13
4.6.1	Energy System Specifications for Kiwenda Water Supply System.....	13
4.6.2	Design summary for Kiwenda Energy Package.....	15
4.7	MAYANGA WATER SUPPLY SYSTEM.....	16
4.7.1	Energy System Specifications for Mayanga Water Supply System.....	16
4.7.2	Design summary for Mayanga Energy Package.....	18
4.8	SSEKANYONYI WATER SUPPLY SYSTEM.....	19
4.8.1	Energy System Specifications for Ssekanyonyi Water Supply System.....	19
4.8.2	Design summary for Ssekanyonyi Energy Package.....	21
4.9	BUYENDE-2 WATER SUPPLY SYSTEM.....	22
4.9.1	Energy System Specifications for Buyende-2 Water Supply System.....	22

4.9.2	<i>Design summary for Buyende-2 Energy Package</i>	24
4.10	KAGULU WATER SUPPLY SYSTEM	25
4.10.1	<i>Energy System Specifications for Kagulu Water Supply System</i>	25
4.10.2	<i>Design summary for Kagulu Energy Package</i>	27
4.11	KASAMBIRA WATER SUPPLY SYSTEM.....	28
4.11.1	<i>Energy System Specifications for Kasabira Water Supply System</i>	28
4.11.2	<i>Design summary for Kasambira Energy Package</i>	30
5	EMPLOYER’S REQUIREMENTS	31
5.1	TRANSPORT VEHICLE	31
5.2	EMPLOYER’S DUE DILIGENCE & WITNESS TESTING.....	31
5.3	IMPLEMENTATION OF ENVIRONMENTAL & SOCIAL MANAGEMENT PLAN.....	32
5.4	SITE ACCESS AND LAND EASEMENT	34
5.5	TRAINING REQUIREMENTS	34
5.6	DESIGN AND PRODUCTION OF IEC MATERIALS AND MANUALS	35
5.7	TESTING AND COMMISSIONING	36

1 GENERAL INTRODUCTION

The following document contains the complete technical specifications for supply and installation of energy systems [Solar-PV water pumping] for use in a structured tender process for powering rural water supply schemes in Uganda.

In some statements in the sections below the words “the Client” has been used; this shall hold the same meaning as “the Employer” and its designated representatives. Also, the words “the Engineer” has been used; this shall hold the same meaning as “the Project Manager” and its designated representatives.

1.1 Documentation included

- a) Standard Specifications (General and technical specifications) for supply, delivery and installation and commissioning of equipment
- b) The Schedule of Drawings for the energy packages.
- c) The Schedule of Quantities and Tender Price Cost Build-up lists the quantities and costs of items to be provided, and shall be completed as required by the bidder.

1.2 Scope of General Specifications

The scope of General specifications entails but not limited to the following:

- International standards, IEC, IEE, ISO and UNBS
- Design, standardization and test of system and equipment
- Treatment of materials like galvanizing, labels, cleaning and painting
- Civil works like building and excavations
- Site treatment, land and environment
- System installation and commissioning requirements
- Operation and maintenance activity and associated O&M manuals

1.2.1 Scope of Technical specifications

The scope of the technical specification entails supply, delivery, installation and commissioning of all equipment for energy packages [Solar-PV water pumping] and associated civil and mechanical works. The Technical Specification details the general system requirements, supply of equipment, standard of design and workmanship, and quality of material for the installations.

1.2.2 Supply, delivery and installation

Supply, delivery, installation and commissioning of individual energy packages for powering water-pumping schemes shall be within the limits of this specification. All such equipment that are essential for the proper functioning of the system shall be, as required by this specification, supplied, delivered and installed by the contractor.

1.2.3 Additional equipment to be supplied

All additional equipment to be supplied shall be as required by this specification and the scope of supply shall take into account:

- Specified quantity of spares as listed herein
- Additional spares as recommended by supplier or manufacturer.

1.2.4 Electrical works

All associated works; supply and installation of electrical equipment and parts shall be done in accordance with the relevant clauses of the most recent edition of ISO, IEC, IEE and UNBS standards.

Electrical works shall include installation of solar array, controller and water pump plus all accessories for necessary interconnections and system control. The installation of an auxiliary lighting system and an Alarm system shall be included within the scope of works.

1.2.5 Civil and Plumbing works

All civil works, materials, shall be done in accordance with the relevant clauses of the most recent edition of the ISO, British Standard [BS] and UNBS standards.

Excavations, Levelling, Buildings and Fencing

Excavations, levelling, construction of a stand-alone and secure pump and guard houses including fences is part of the scope of work for the water supply schemes. The pump house building will accommodate the water pumping electronics and the auxiliary lighting system while the guard house will be utilized by the pump attendant. The roof of the pump house will accommodate the PV module powering the auxiliary lighting & alarm system.

Plumbing

Plumbing from the pump to the borehole head shall be within the scope of works. Additional works associated with extending pipe works from pumping point up to an appropriate point, as approved by the Project Manager, for mains connection to the reservoir shall be included within the scope of works.

NOTE:

Designs, Drawings and bills for the following works shall be submitted to the Project manager/Engineer for approval:

- Clearance, levelling of site, and Concrete bases for supporting the Array
- Mounting structure and set-out of the solar array
- Fencing of the site [as described above]
- The pump house and the associated plumbing works inside the pump house

2 GENERAL TECHNICAL SPECIFICATIONS

2.1 Standards

Although IEC Standards for workmanship, material and equipment have been selected in these specifications as a basis of reference, other standards and specifications of other Agency member countries and recommendations of standard international organizations, will be acceptable provided they ensure equal or higher quality than those specified, and provided furthermore that the Contractor submits for approval, detailed specifications which he proposes to use.

The goods or equipment to be supplied must have a type-test certificate from an accredited testing and certification organization stating that the PV system components meet or exceed the specifications. Organizations accredited according to ISO 17025:2005 (*General requirements for the competence of testing and calibration laboratories, and have those specific standards within their scope of accreditation*), or equivalent standards will be acceptable for issuing the component certifications.

Except where modified by this specification, equipment and materials shall be in accordance with IEC (International Electrotechnical Commission) and ISO (International organization for Standardization) Standard. If relevant IEC and ISO Standards are not available in any case or cases then relevant National Standards (the Uganda Standard by Uganda National Bureau of Standards) shall apply, if available, and such National Standards shall be proposed by the Contractor for approval for the purpose by the Project Manager.

When IEC or ISO Recommendations or National Standards are referred to the Edition shall be that current at the Date of Tender, together with any Amendments issued to that date. A list of national standards for equipment not complying with IEC standards to be used in the manufacture and construction of the equipment shall be given.

If requested by the Project Manager, the Contractor shall supply at his own expense three copies in English and one in the original language of any national standards, which are applicable to the Contract.

All apparatus and materials supplied and all work carried out shall comply in all aspects with the requirements of the Purchaser and such regulations which may be in force. The Bidder shall undertake any and all modifications required by the authorities in order to comply with the regulations, and produce all certificates, if any, at no extra charge to the Client

All Civil works shall be done according to the relevant British standards (BS)

2.2 Design And Standardization

The Contract Works shall be designed to facilitate inspection, cleaning and repairs, and for operation in which continuity of service is the first consideration. All apparatus shall be designed to ensure satisfactory operation under the atmospheric conditions prevailing at the Site under such sudden variations of load and voltage as may be met with under working conditions on the system, and short circuits, including those due to faulty synchronizing,

within the rating of the apparatus. The general operating conditions are given in this specification.

All equipment offered shall be the product, of recognized and experienced manufacturers and shall be proven equipment of the same basic design and size similar to that which has been in successful continuous operation for at least three years preferably under similar climatic conditions. Proven plant reliability and high availability are of prime importance and the attention of the Tenderer is drawn to these particular requirements.

The Contract works must be carried out strictly in accordance with the following documents:

- i) BS 7671: 2008: Requirements for Electrical Installations or “The IET Wiring Regulations” published by the Institution of Engineering and Technology, London (with local amendments, where applicable),
- ii) Uganda laws and by-laws and supply and local authority requirements,
- iii) Relevant British Standard Specifications and Codes of Practice, published by the British Standards Institution (hereafter referred to as B.S. and C.P. respectively) as implemented in Uganda,
 - a) UNBS US 149 - 1:2002 Secondary Cells and Batteries for Solar Photovoltaic Energy Systems - Part 1: General Requirements and Methods of Test (2nd Edition),
 - b) UNBS US 152:2000 Code of Practice for Installation of Photovoltaic Systems,
 - c) UNBS US 463 - 6: 2005 Photovoltaic Devices - Part 6: Requirements for Reference Solar Modules
- iv) Any working drawings produced by the Bidder and approved by the Engineer and
- v) The Engineer’s instructions, drawings and details.

The Bidder shall undertake all modifications demanded by the authorities in order to comply with the regulations, and produce all certificates, if any, from the authorities without extra charge.

The Client and Consultant shall witness factory acceptance tests of the solar PV panels, water pumps, and inverters at the manufacturer’s site.

The design shall incorporate every reasonable precaution and provision for the safety of all those concerned in the operation and maintenance of the Contract works and of associated works supplied under other Contracts.

Materials, which are susceptible to mould growth in the tropics, shall be treated to exclude moisture and prevent growth of mould after all machining has been carried out.

All material used shall be of the best quality and of the class most suitable for working under the conditions specified and shall withstand the variations of temperature and atmospheric conditions arising under working conditions without distortion or deterioration or the setting up of undue stresses in any part and also without affecting the strength and suitability of the various parts for the work they have to perform. No welding, filling or plugging of defective parts will be permitted without the sanction in writing of the Project Manager.

Corresponding parts liable to renewal shall be interchangeable. When required by the Project Manager, the Contractor shall demonstrate this quality.

2.3 System Design Parameters And Configurations

Selection of equipment

All equipment and associated balance of system components selected shall operate well and reliably within the system as a whole. Particular emphasis shall be placed on standard system design, as specified for electrical-mechanical-civil works, to cater for all component requirements, and as such, shall be appropriately matched to improve reliability and life of system as a whole.

System configuration

For purposes of standardization, one particular solar-PV system configuration is specified herein, and is favored for each of the systems to be installed in this contract; maximum power point (MPP) input voltage for the inverter as 630Vdc.

The solar PV system design and configuration shall allow for easy fault-finding by system operators. This may include the use of visual indicators, alarms to determine whether various components or groups of components are performing as per specification, or are faulty. The main components of the solar PV system shall be integrated in such a way as to allow easy access/replacement (in case of failure) with a similarly functioning component.

All equipment specified for outdoor use shall be splash waterproof to IP54 and UV resistant. All wiring, enclosures and fixtures that are mounted indoors shall be resistant to insect and dust intrusion.

Level and reliability of supply

The level and reliability of supply required is usually specified in terms of the design downtime allowed, or more specifically, the 'probability of loss of power' to the load due to system design and sizing. For example, a loss of power/water probability of 1%, i.e. an ability of the system to meet the full design daily load energy/water demands on no fewer than 361 days a year (averaged over 20 years). In this case, system reliability is translated into the ability to supply the required water demand that meets 70% utilization capacity, as a percentage of total water needs estimates for the Small Town or Rural Growth Centre.

2.4 System Control

System control shall be applied to the facilities as a measure to start, stop and or make adjustments when demand for relief of stress is required.

For Solar-Photovoltaic [Solar-PV] systems, automated electronic inverters, electronic motor drives/controllers, and alike shall be used for power conversion and system control.

Communication between human operator and machines shall be by LCD and LED display devices, as alarms for relief of stress to the affected machines. These maybe but not limited to system overload, over-voltage, full-tank shutoff or pump dry-run protection. Remote sensors/switches shall be used for auxiliary system control.

2.5 Galvanizing

Galvanizing shall be applied by the hot dipped process. The preparation for galvanizing and the galvanizing process shall not affect the mechanical properties of the material being coated.

Drilling, punching, cutting, removal of burrs and all machining shall be completed before galvanizing. The zinc coating shall be smooth, clean and of uniform thickness and free from defects. The preparation for galvanizing and the galvanizing itself shall not adversely affect the mechanical properties of the coated material.

All galvanized steel, which has been cut, drilled or worked on site, shall be painted with an approved zinc rich paint to prevent rusting.

The average thickness of the zinc coating shall be equivalent to not less than 600 gr/m² or 85 μ m thickness of zinc for all surfaces, except steel wires, bolts and nuts. Galvanizing will be tested in accordance with the appropriate IEC or equivalent standards in order to determine that it complies with this requirement.

The thickness of the zinc coating for steel wires shall be in accordance with a national standard and shall be approved by the Engineer. All galvanized wires on which tools have been used or cut shall be treated with approved bitumastic paint.

All bolts and screwed rods for the connection of galvanized steel parts shall be galvanized including the threaded portion (s) to a minimum average coating weight of 305 g/m² or 43 μ m thickness. The threads of all bolts and screwed rods shall be cleared of smelter by spinning or brushing. A die shall not be used for cleaning the threads unless specially approved by the Project Manager. All nuts shall be galvanized. White rust formation subsequent to galvanizing must be inhibited using an approved inhibitor applied according to the manufacturer's instructions.

Surfaces in contact with oil shall neither be galvanized nor cadmium plated, unless finished with oil resisting varnish.

Material on which galvanizing has been damaged shall be re-dipped unless, in the opinion of the Project Manager the damage is local and can be repaired by applying a coat of galvanizing repair paint. Where such repair is authorized, the damaged area shall be cleaned by wiping with clean rags saturated with mineral spirits or xylene followed by wire

brushing. After wire brushing, the area shall be re-cleaned with solvent to remove residue and shall be given a minimum of two coats of zinc rich paint in accordance with the manufacturer's instructions.

2.6 Steel, Aluminum And Alloys

All material will be appropriate to local operating conditions. Aluminium shall be of high commercial quality. The composition, including the percentage and nature of any impurities, shall be stated in the technical data sheets. Wood is not accepted for outdoor use. All other alloys shall be of approved compositions as stated in the Schedules.

2.7 Labels

All equipment shall be clearly and permanently labelled in English, to the approval of the Project Manager. Where labels are provided for making clear the method of operation of equipment, they shall be concise and preferably diagrammatic in form.

Danger labels shall have red lettering on a white background. All other labels shall have black lettering on a white background.

Before production of labels and notices the Contractor shall submit to the Project Manager full scale drawings of the proposed labels.

NOTE: For solar-PV modules, the serial number, date of manufacture, the name of the manufacturer, the name of the Employer and that of the project shall be embedded inside the encapsulation of the solar modules i.e., MWE/ERT-EASP/*Serial Number*: **Property of Government Uganda**

2.8 Bolts And Nuts

Bolts, nuts and washers on outdoor equipment shall be of non-corroding material or hot dip galvanized. No bolt or stud shall project through its nut by more than approximately 10 mm or four threads whichever is the less.

Suitable special spanners shall be provided for bolts and nuts that are not properly accessible by means of an ordinary spanner. All steel bolts of any diameter on a structure shall be of the one grade of steel.

2.9 Cleaning And Painting

Successive coats of paint shall be applied to a clean, dry and properly prepared surface. Each coat shall be compatible with the preceding coat and the coat to follow.

The colour and shade of all painted external surfaces shall be to the approval of the Project Manager.

All paintwork, which has been damaged during transport and erection, shall be made good to the approval of the Engineer.

2.10 Corona And Radio Interference

All equipment shall be designed so as to minimize corona or other electrical discharge and radio interference.

2.11 Drawings

Lists of drawings attached to the Specification, also those required to be submitted to the Project Manager with the completed Tender, shall be listed under section 7, item 9, together with the requirements for the production of Contract drawings.

2.12 Type Tests And System Functional Guarantee Tests

Type tests and routine tests at Works and routine tests at site shall, unless otherwise specified, be carried out in accordance with the provisions contained in Section 3. Six copies of all test results shall be provided for record purposes.

System functional tests shall be carried out for a period of three (3) months after system commissioning to ensure that the functional guarantees are fulfilled and that the installations attain operational acceptance.

Testing of Earthing System

The resistance of the earth continuity system, when measured between the main earthing point and any other point in the installation, including all conduit and other metal work which may provide a path to earth, shall not exceed 5 ohms, where steel conduit forms part or whole of the system, or 1.0 ohms if the earth continuity system is composed entirely of copper, copper alloy or aluminium. The Bidder is expected to allow for any necessary additional materials required to achieve the above resistance values.

Installation Testing

After completion and before commissioning, the entire installation shall be subjected to the following tests and any faults found shall be rectified by the Bidder at no extra cost. The pricing for testing of the installations shall be indicated in Schedule No. 4. Installation and Other Services.

- a) **Polarity**; All fuses and control devices shall be connected in live conductors only.
- b) **Insulation Resistance**; When tested with a 500 VDC supply, the insulation resistance between conductors of live lines, lines and neutral, line and earth, neutral and earth shall not be less than 1 mega-ohm.
- c) **Earth Continuity Resistance**; Resistance of earth continuity measured from a consumer's unit to the furthest end of a circuit shall not exceed 0.5 ohms. In addition to the above, the following tests and inspection shall be carried out where applicable:
 - i. earth loop impedance,
 - ii. operation of all other protective relays and devices and
 - iii. visual inspection.

Commissioning and System Demonstration

The whole installation shall be tested to the statutory requirements of the Service Provider and IEE Wiring Regulations, and commissioned in the presence of and to the satisfaction of the Consultant.

2.13 Spare Parts

Particulars of spare parts and optional items, which may or not form part of the Contract at the Employer's discretion, shall be agreed. The appropriate schedule should be completed by tenderers giving their recommendations and prices for spares that they believe should be carried by the Employer.

2.14 Erection Marks

All plant that requires assembly at Site shall have distinguishing marks on it to facilitate erection and to identify the material in relation to drawings, material lists or shipping documents. All marks shall be legible and easily visible. Where relevant, erection marks shall be stamped before galvanizing and shall be clearly visible after galvanizing.

2.15 Packing Of Material

Packing shall give adequate protection to the enclosed materials against mechanical damage during transport to its final destination, including rough handling during sea, rail and road transport and transition from one mode of transport to another.

Packing should preferably be stout close-boarded wooden cases of adequate thickness, suitably braced banded, and lined internally with water resistant material.

All items in cases or crates shall be secured so that they are not free to move and cannot work loose in transport. If rotating parts are shipped within their bearings or mountings they must be adequately braced and restrained to prevent relative movement. Bags of loose items shall be placed in bags in a case, each bag having stitched onto it a metal label indicating the number and nature of its contents. Where a filler material is used in a case to restrict movement or provide additional protection is used in a case to restrict movement or provide additional protection it must be inorganic and non-hygroscopic.

All surfaces liable to corrosion shall be thoroughly cleaned and special steps, adapted to the nature of the materials and the time interval between packing unpacking shall be taken to prevent corrosion. These steps may constitute the greasing on surfaces, the application of a protective coat, enclosure of the items in a hermetically sealed container, the addition of vapour phase inhibitor paper to the package, or other approved means.

Cases shall be marked with large lettering to show which side up the case is to be, and, if the contents are fragile marked "FRAGILE" in large letters with the international wine glass symbol. Packages shall be marked with their place of destination in such a way that rough handling or the effect of weather cannot remove or obliterate the marking. Each item shall be marked with its gross weight, and for all lifts over two tons, marks on the cases shall show where the weight is bearing, and the correct positions for the slings.

The cases shall, whenever possible, be packed so that they can safely be placed on the ability of those who will handle the cases to read written instructions or to understand pictorial ones. Cases that have to be slung in a certain way shall, as far as possible, be so constructed that they cannot conveniently be slung in any other way and packages shall preferably be so large that they cannot be easily rolled over or thrown about; thus when practicable small cases shall be crated together to form one larger one. Crates shall be sufficiently strong to be capable of being slung from the outside even when provision is also made for slings to be attached direct to a major article inside.

Special steps shall be taken to guard against theft during transport. No small items, such as padlocks, nameplates and so forth, which could be torn off or unscrewed, shall be accessible. Cases, crates, barrels and drums shall be banded in such a manner as to obstruct the theft of any of the timber used for packaging, and the bands shall be so secured that they are not rendered ineffective by shrinkage of the wood.

A descriptive and fully itemized list shall be prepared of the contents of each packing case. A copy of this list shall be placed in a waterproof envelope under a metal or other suitable plate securely fastened to the outside of one end of the case, and its position indicated by stencilling on the case. Where appropriate, drawings showing the erection markings of the items concerned shall be placed inside the case.

All stencilled markings on cases and crates, or other markings on descriptive metal tabs fixed to cable drums, bundles of structural steelwork and so forth, shall be applied in two places with a material which cannot wash off, and shall be additional to any erection or other marks or impressions which may be specified elsewhere.

All packing cases shall remain the property of the Employer.

Shipping marks shall conform to the pattern shown below. Shipping marks are to be stencilled in oil based paint in block letters and symbols. When unobstructed flat smooth surfaces of sufficient size are not available on the case for the shipping marks they are to be stencilled on marine-ply notice boards of adequate size and of at least 6 mm thickness securely fastened to the packing case.

2.16 Installation And Commissioning

2.16.1 General requirements

Before a system is installed, precautions and extra design checks shall be made by the contractor to ensure that the designer has optimized the system for electrical performance.

2.16.2 System Installation

Procedures and methods of construction of system and assembly of system components shall be done to the required international standards and as recommended by the respective manufacturer of the equipment. Any such deviations shall be reported to the Engineer for approval. All such construction works shall conform to the standard Electrical, Mechanical and Civil requirements for water pumping systems.

NOTE: Before roll out of all the installations, the Contractor shall be required to construct and commission a "PROTO-TYPE" energy package at one of the sites as directed by the Project Manager. Subsequent works on other sites shall commence when the Employer and the Project Manager approve that actually the "Proto-type" installation is fully functional and has achieved operational acceptance as per the requirements of the contract.

2.16.3 System commissioning

System commissioning shall be done before handover of the facilities. All such activities shall be done in the presence of the client and the Project Manager. The contractor shall be required to provide a commissioning checklist before commencement of the activity.

2.17 Operation And Maintenance

Systems should be as maintenance free as possible, and maintenance requirements should be predictable. Where special tools are required for routine maintenance, they are to be supplied as a part of the contract, and included in the tender price.

2.18 Operation, Maintenance And Repair Manuals

Operations, Maintenance and Repair manuals shall be provided for all individual pieces of equipment and electrical systems. The manual shall include the following information:

- a) On the exterior of the manual denote the following "OPERATION, MAINTENANCE AND REPAIR MANUAL, "the name of the project, location of the building, and the name of the Contractor.
- b) The manual shall include the name, addresses, and telephone numbers of each subcontractor installing the equipment and systems and the name, address and phone numbers for the local representatives for each item of equipment and each system.

The manual shall include, but not be limited to the following:

- a) A system layout showing circuits, devices, and controls
- b) Wiring diagrams with the data to explain detailed operation, maintenance and repair for each component or system.
- c) A control sequence describing the startup, operation and shutdown.
- d) Detailed instructions on the function of each piece of equipment or system to include the startup, operation, repair and shutdown procedures.
- e) Provide a detailed parts list for each piece of equipment or system including names, addresses and phone numbers of suppliers.
- f) The manual shall be complete in all respects for all equipment, control, accessories and systems.
- g) The manual shall be clearly and concisely written and shall be specifically prepared for makes, models and types of equipment and systems furnished.
- h) General literature shall be modified or highlighted for the specific piece of equipment or system furnished.

Other materials needed for operation and maintenance shall include:

- a) The System logbook for entry of all maintenance and service actions
- b) Plastic laminated sheets describing regular local maintenance requirements using pictograms

2.19 Fault-Finding And User Friendliness

The system design and configuration shall allow for easy fault-finding by system operators. This may include the use of visual indicators [LCD/LED displays], alarms, instruments, and

volt/amp meters to determine whether various components or groups of components are performing as per specification, or are faulty.

The inverter or pump controller shall be non-programmable by the human operator and LEDs of LCD used as communication interface should be as simple as possible to understand.

2.20 Site Treatment, Land And Environment

2.20.1 Entry onto the Sites

Prior to the commencement of operations, the Employer or his authorized representative shall supply to the Contractor the names and addresses of the contact persons. The Contractor shall notify the Client or his authorized representative 14 days in advance of his intention to start work at the site.

The Contractor shall keep records of the dates of his entry onto and departure from all property and lands of each site, together with the date of removal of all the enclosures, and shall furnish copies of these records when required by the resident engineer.

2.20.2 Survey of Properties, Lands and environment

Where appropriate the Employer or his authorized representative shall arrange for surveys to be carried out, in conjunction with the Contractor, owners or occupiers, of the properties, lands or vegetation that may be affected by the works.

Before any work affecting such properties, lands or vegetation commences, the Contractor shall confirm to the Employer or his authorized representative in writing that the relevant survey is a true and accurate record of their condition. Environmental Impact Assessment and mitigation measures adopted shall be in accordance with the most recent guidelines and standards of NEMA.

2.20.3 Site Fencing

Where the types and locations of temporary fencing are described in the contract, the Contractor shall erect such fencing as soon as he is given possession of the relevant portions of the site. The Contractor shall regularly inspect and maintain all fencing and any defects made good without any delay.

Access shall be provided in temporary fencing as necessary for the occupiers of the adjacent lands where necessary. Temporary fencing shall remain in place until either permanent fencing or the works are sufficiently completed to enable that portion of the site to be brought into use.

2.20.4 Interference with Land Interests

The Contractor shall confine his constructional operations within the site, or such other areas of land as may be negotiated, and shall instruct his employees not to trespass.

Subject to any unavoidable disturbance that may be necessitated by the execution of contract, the Contractor may not interfere with any other activities e.g. fishing, which may be enjoyed near the site.

Before exercising any right negotiated in connection with wayleaves or accommodation outside the site, the Contractor shall notify the Client or his authorized representative in writing of such arrangements.

2.20.5 Interference with Access to Properties

Before interfering with access to any property, the Contractor shall provide alternative arrangements. The Contractor shall notify the Client or his authorized representative and the relevant occupiers in writing 14 days in advance of any such interference and shall confirm to the resident Engineer that alternative arrangements have been made.

2.21 Concrete Works

2.21.1 General

Concrete shall be used for Array ground mounts, bases of reservoirs, tap stands and for foundations of pump houses.

2.21.2 Materials

Concrete shall be composed of cement, sand and coarse aggregate, water as required and well mixed and brought to the proper consistency. In general, cement will be accepted on manufacturer's certification of compliance with specification requirements. Concrete shall except where otherwise described in the contract, be produced transported and assessed for compliance with the specification in compliance with the relevant provisions of BS 5328 Parts 3 and 4.

2.21.3 Cement

I) General

Cement serves as an adhesive and glues together the sand and stone in the concrete mix. Cement shall be ordinary Portland cement. It shall be factory produced by the manufacturer and shall comply with the provisions of the appropriate British Standard below:

Type	BS
Ordinary Portland	12
Masonry	5224

II) Storage of Cement

Cement easily absorbs moisture from the air and as a result loses strength during long periods of storage. Typical losses are given in the table below.

Period of Storage	Loss of Strength
3 Months	20%
6 Months	30%
12 Months	40%

Cement on a project site shall be stacked in a closely packed pile, not greater than 10 bags high (to prevent bottom bags from bursting) Close packing reduces air circulation between the bags. The cement pile shall be raised on a platform above the floor. Aged cement forms lumps. All lumps should be screened out of the cement before use; lumps, which cannot crumble by fingers, should not be used.

2.21.4 Water

Water in the concrete mix serves two purposes. First to take part in the hydration reaction of the cement and secondly to make the mix fluid and plastic enough so that it can easily be worked and placed. Water shall be free from objectionable quantities of silt, organic matter, salts and other impurities.

2.21.5 Sand and Coarse Aggregate

- a) Sand and coarse aggregate shall be furnished by the contractor from any approved source. The sand particles shall be clean, hard, dense, durable, uncoated rock fragments that will pass a screen having 4 - 6.50 mm openings. The sand shall be well graded from fine to coarse and shall be free from injurious amounts of dirt, organic matter and other deleterious substances.
- b) The coarse aggregate shall consist of natural gravel or crushed rock and shall be clean, hard, dense, durable, uncoated rock fragments, free from injurious amounts of thin pieces, organic matter, or other deleterious substances. The coarse aggregate shall be reasonably well graded from 5 - 37.5 mm, and shall be separated into two sizes by an intermediate screen having 20 mm square openings. Screens having openings of other sizes and shapes may be used, if equivalent results are obtained.
- c) The Client or his authorized representative reserves the right to test the sand and coarse aggregate and, if required, the Contractor shall submit, for preliminary tests and approval, representative samples of the sand and coarse aggregate proposed for use in the concrete works.

2.21.6 Composition of concrete

- a) Sand and coarse aggregate shall be mixed in proportions as directed by the Client or his authorized representative.
- b) The slump of concrete shall not exceed 50 mm for slabs, and 75 mm for all other concrete.

2.21.7 Concrete Mixes

Typical concrete mixes are given below:

Concrete Mix	Cement m³	Sand m³	Aggregate m³
1:2:4	0.25	0.50	1.0
1:3:6	0.16	0.50	1.0

a) Batching and Mixing

1. The sand and coarse aggregate shall be weighed and proportioned on the basis of integral bags of cement unless the cement is weighed. Weighing equipment of the beam type shall be used. The Contractor shall provide equipment and shall

maintain and operate the equipment as required to accurately determine and control the amount of each ingredient entering the concrete.

2. Batching shall be such that the combined inaccuracies in feeding and measurement of materials will not exceed 1.5% for water and weighed cement and 2% for sand and each size of coarse aggregate.
3. The concrete shall be uniform in composition and consistency throughout the mixed batch, and from batch to batch, except where changes in composition or consistency are directed. The mixing time shall be at least 1.5 minutes.
4. Excessive over-mixing requiring the addition of water to preserve the consistency will not be permitted. The mixers will and their operation are such that the concrete throughout the mixed batch and from batch to batch is uniform with respect to both consistency and grading. Any concrete retained in truck mixers so long as to require additional water to permit satisfactory placing shall be wasted.
5. Where a mixing pad is used it shall be as close to the final placing point as possible so as to prevent segregation (heavier aggregate sinking to the bottom and water rising to the surface). Concrete shall be re-mixed with a steel trowel prior to placing.

b) Forms, Preparations for Placing, and Placing

1. Forms shall be used to shape the concrete to the required lines. The surfaces of construction joints shall be clean, rough and surface dry when covered with fresh concrete or mortar. Cleaning shall consist of the removal of all laitance, loose or defective concrete, coatings, sand, sealing compound if used, and other foreign material.
2. The methods and equipment used for transporting the concrete, and the time that elapses during transportation, shall be such as will not cause appreciable segregation or slump loss in excess of 25mm in the concrete as it is delivered to work. Re-tempering of concrete will not be permitted. Any concrete, this has become so stiff that proper placing cannot be assured, shall be wasted. Formed concrete shall be placed in continuous approximate horizontal layers, the depth of which shall not exceed 500mm.
3. Concrete shall be vibrated until it has been consolidated to the maximum practicable density, is free from rock pockets of coarse aggregate, and closes snugly against all surfaces of forms and embedded materials.
4. All porous and fractured concrete shall be removed by chipping openings into the concrete shall be filled with dry pack, mortar or concrete as directed.
5. Exposed unformed surfaces of concrete shall be brought to uniform surfaces and worked with suitable tools to a reasonably smooth wood float or steel trowel finish as directed.

2.21.8 Reinforcement and Binding Wire

a) General

1. Steel reinforcement bars shall be placed in the concrete where shown on the drawings. Before reinforcement is placed, the surfaces shall be cleaned of heavy flaky rust, dirt, grease or other foreign substances. Reinforcement shall be

accurately placed and secured in position so that it will not be displaced during the placing of concrete.

2. Reinforcement will be inspected for compliance with requirements as to size, shape, length, splicing, position and amount after it has been placed.
3. Binding wire for the steel reinforcement shall be 1.6mm diameter finally annealed mild steel wire complying with BS 105.
4. Steel reinforcement shall comply with the relevant provisions of the appropriate British Standard, as set out below:

Type	BS
Carbon steel bars	4449
Cold reduced steel wire	4482

b) Spacing of the Reinforcement

Spacing of the steel in the concrete should distribute the cross sectional area of the steel uniformly for a floor slab the bar area should not exceed 0.23% of the total cross sectional area. The following schedule will be used. Table showing reinforcement schedule

Type of slab	Thickness mm	Spacing		
		6mm	8mm	10mm
Floor	80	15	30	40

2.21.9 Mortar

Mortar is a mixture of cement lime and sand in various proportions depending on the desired strength. It is used in masonry and to plaster walls for water proofness. Mortar shall be mixed only and when as required in the relevant proportions indicated in the following table, until its color and consistency are uniform. The constituent materials shall be accurately gauged allowing for the bulking of sand.

Nominal Mix by Volume	
Class	Cement: Lime: Sand
M1	1:1/4:3
M2	1 1/2:4:4 1/2

2.21.10 Surface Finishes

a) Surface Finishes Produced without Formwork

Screeded Finish: The concrete shall be levelled and screeded to produce a uniform plain or ridged surface as required. No further work shall be applied to the surface unless it is a first stage for a wood float or steel trowel finish.

Wood Float Finish: The screeded finish shall be wood floated under light pressure to eliminate surface irregularities.

Steel Trowel Finish: When the moisture film has disappeared and the concrete has hardened sufficiently to prevent laitance from being worked to the surface. The surface to the wood float finish shall be steel troweled under firm pressure to produce a dense, smooth, uniform surface free from trowel marks.

Where the type of finish is not given, it shall be wood float finish.

[b] *Surface Finishes Produced with Formwork*

Rough Finish: This finish shall be obtained by the use of moulds or properly designed forms of closely jointed sawn boards. The surface shall be free from substantial voids, honeycombing or other large blemishes.

Fair Finish: This finish shall be obtained from forms designed to produce a hard smooth surface with true clean arises. Only very minor blemishes shall be permitted and there shall be no staining.

Fair Worked Finish: This finish shall be obtained by first producing a fair finish and then filling all the surface blemishes with fresh, specially prepared cement and fine aggregate paste while the concrete is still green where possible. After the concrete has been properly cured the faces shall be rubbed down, if required to produce a smooth and even surface. If the surface is to be exposed during the final work, every effort shall be made to match the color of the concrete.

2.21.11 Treatment of Concrete

a) Curing of Concrete

Concrete shall be cured for a period not less than that given in the following table, by methods that shall ensure that cracking, distortion and efflorescence are minimized.

Type of Cement	Ambient Conditions after Casting	Minimum Period of Curing and Protection Above 10 C
BS 12 and BS 4027	Average	3 days
	Poor	4 days

b) Records of Concreting

The Contractor shall keep up to date records of the dates and times when concreting is carried out and of the weather conditions at that time. The records shall be available for inspection by the Engineer.

c) Tolerance for Concrete Surfaces

Concrete surfaces in the final work shall have no abrupt irregularities to the extent observable by the eye. Subject to retaining the required concrete cover, other deviations from the surfaces described in the contract shall be no more than the permissible amounts.

Type of Finish	Deviation from line, level, verticality, cross sectional dimension or length (mm)
Screeded or Rough	10

Any other	5
-----------	---

2.21.12 *Grounding and Lightning Protection*

All structures having erection equipment such as surge arresters, PLC equipment and load break switches shall have a protection pole ground installed.

The pole ground lead shall extend above the top of the pole and shall be bonded to the surge arresters, plate bolts, tension insulator bolts, and in general all metallic supports installed on the structure.

The impedance of the protection ground shall be less than 5 Ohms according to VDE 141 Standard.

Grounds rods shall be driven in undisturbed earth in accordance with the construction drawings. The ground wire shall be attached to the rod with a clamp and secured to the pole with staples. The staples on the ground wire shall be spaced 600 mm apart except for a distance of 2.5 m above the ground rod and 2.5 m down from the top of the pole where they shall be 150 mm apart.

The equipment ground and lightning protective equipment shall be interconnected and attached to a common ground wire.

Equipment grounds and especially solar array should normally employ ground rod or trench type ground electrodes interconnected to achieve equipotential bonding.

In case these requirements cannot be fulfilled by installing a reasonable amount of grounding material, step and touch voltages have to be measured after finalization of the installations and depending on the results of these measurements additional protection measures might become necessary. These measures could include gravelling of an area around electrical installations or application of additional ground wires and ground rods.

For this purpose, the contractor should state a price for every meter additionally installed earth wire (material and works).

2.21.13 *Measurement and Payment*

1. Payment for furnishing and placing reinforcement bars will be made at the unit rate per lumpsum as indicated in the price schedule and will include the cost of furnishing or other approved supports, if used; cutting, bending cleaning, and securing in position all the reinforcement as shown on the drawings or as directed by the Client or his authorized representative.

2. Measurement for payment of concrete will be on the basis of concrete having the dimensions shown on the drawings or by the Client or his authorized representative. Upon removal of the formwork, the dimensions of the concrete structure will be measured and the volume computed. Payment for the concrete will be made at the unit rate per cubic meter shown on the schedule, which unit rate shall include the cost of furnishing all labor and materials.

2.22 Guarantee and Warranty requirements

The contractor shall issue the water pumping system guarantee certificate for a period of two (2) years, under which defects liability conditions shall be applied as required by the General Conditions of Contract.

Further still, as a contract requirement, the contractor shall as well furnish warranty certificates for each major component (solar-PV modules, Inverter, Water Pump) obtained from the equipment manufacturers. The warranty certificates for solar-PV modules, inverters and pumps shall be Twenty Five (25) years, five (5) years and Two (2) years respectively

It should be noted that solar-PV modules shall have guaranteed capacity for minimum 25-years, such that, 10% degradation is expected after 10-years (available power output is 90% of rated capacity after 10years) and 20% degradation is expected after 25years (available power output is 80% of rated capacity after 25 years).

2.23 Energy Package contents and Ancillary Works

2.23.1 Contents of the Energy package for a water-pumping scheme

The water-pumping scheme as a whole shall include the following units namely:

- The energy package [Solar-PV] and electrical accessories
- The power inverter and Pump drive/controller and accessories such as dry-run protection and full-tank shut-off
- The water source and draw-pipe accessories
- The Water pump, water pipes and accessories (pressure gauges, Valves and bulk meter)
- The pump house that will also contain a scheme attendant room and pump control room

2.23.2 Ancillary works

a) Civil works

Civil works shall include:

- The fencing of the Pumping station, that is, an overall water scheme fence with chain link wire and barbed wire on top.
- Site grabbing and levelling
- Placing of machine-crushed stone aggregate in the area covered by solar modules
- Construction of concrete curb-line along the boundary of the stone aggregate area
- Planting of grass in the area that is not covered by solar array
- Water Tank and Tank stand

b) Other ancillary works

These include:

- The Auxiliary Lighting system.
- Alarm and intrusion detection system with siren

c) Laying of pipes/ conduits

Plastic pipes/conduits shall be used for carrying underground electric cables from energy source to water source point. They will be done to the following specification:

- Where pipes are required to be bedded directly on the trench bottom, the final surface shall be trimmed and levelled to provide even bedding for the pipeline and shall be free of extraneous matter that may damage the pipe or its sleeves.
- Suitable measures shall be taken to prevent soil or other material from entering pipes and to anchor each pipe to prevent floatation or other movement before works are complete.
- No protective cap or other appliance on the end of the pipe or fitting shall be removed permanently until the pipe or fitting which it protects is about to be jointed. Pipes and fittings, including any lining or sheathing, shall be examined for damage and the joint surfaces and components shall be cleaned immediately before laying.

3 TECHNICAL SPECIFICATIONS OF ENERGY PACKAGE COMPONENTS

3.1 Solar-PV System Specifications

3.1.1 General introduction

Abstraction of water from the relevant sources using solar energy related equipment shall be referred to as Solar Photovoltaic [SPV] water pumping system. The modules, panels and array shall be referred to as Solar-PV modules, -panels and –array respectively.

When designing and installing the system, the following precautions shall be taken into account.

- The proposed pump site shall be examined to determine its suitability for the installation.
- It should be noted that Uganda lies within the tropics; hence the solar panels require a south/north facing location pointing to the equator.
- Suitable locations shall be found for the water pump (surface), controllers, storage tank and other system components.
- The solar array shall be as close to the pump as possible to minimize wire size [voltage drop precautions] and installation cost.
- If batteries are to be used, they must be in a reasonably dry/temperature controlled location with proper venting and shall be of deep cycle-maintenance free type.
- The voltage configuration of the panels that make up the array shall be in accordance with the voltage input requirements of the inverter/controller, preferably 600VDC.

This section deals with general specifications, definitions and abbreviations to be used in the Technical specifications of the Solar-PV power plant

3.1.2 General specifications for SPV plants

The technical characteristics of all hardware must comply with the Technical Specifications herein, and the specified scope of works in Chapter 1 and the general technical specifications of Chapter 2.

Structural Robustness: All components of the Solar-Photovoltaic (SPV) power plant shall be robust, neatly assembled, firmly fixed supports in ground and designed to allow easy access using adequate tools. The SPV power plant shall have a minimum useful life of 20 years, with solar modules warranted for 25 years.

Protection against Corrosion and rusting: All components and accessories shall be made from corrosion resistant material and made good to be rust-free by galvanizing and or painting of all surfaces that are exposed to the ambient conditions. All materials shall be resistant to effects of excessive moisture, water, and ambient temperature. Resistance to corrosion shall be according to DIN 8985 standards.

Protection against thefts: All equipment, parts and accessories shall be well designed and fastened against theft, with considerable difficulty to un-screw the solar modules or metal parts from the entire assembly.

3.1.3 General definitions

For the purposes of these Technical Specifications, the following definitions shall apply:

Air mass: A numerical value that quantifies the overall measure of the amount of atmosphere through which solar radiation has to pass to earth (solar module surface). At sea-level, when the sun is directly overhead, the air mass is AM1.5 otherwise it is quantified as AM1.5 for tilted surfaces.

Apparent power: The AC Power product of the measured root mean square (r.m.s.) of voltage and current expressed in the units of volt-amperes (VA).

Blocking diode: A diode used to prevent battery discharge through the photovoltaic array at night.

Bypass diode: A diode used to prevent damage to the photovoltaic module under a partial shade condition.

Cycle of battery: A sequence of a discharge followed by a charge or a charge followed by a discharge under specified conditions.

Efficiency (of inverter): The ratio of the output power to input power.

Fill factor (FF) of solar modules: Defines the performance of solar modules when loaded and unloaded parameters are compared at STC/NOCT conditions. It is defined as:

$$FF = (I_{max} \times V_{max}) / (I_{sc} \times V_{oc})$$

Where:

V_{max} is the module voltage at maximum power point,

I_{max} is the module current at maximum power point,

V_{oc} is the module voltage on open-circuit,

I_{sc} is the module current on short-circuit

Harmonics: Components of the output voltage or output current waveform that have frequencies different from that of the standard AC frequency. They exist if the waveforms are not exactly sinusoidal.

Inverter: A device which changes DC input into AC output.

Load Reconnect voltage: The voltage set-point of the regulator at which the loads are reconnected to the battery after load-shed has occurred.

Load sensing: A characteristic of an inverter such that if no load is connected to the output of the inverter the inverter automatically switches to a standby mode and the input current is minimized.

Load-shed voltage: The voltage at which the regulator is set to disconnect loads to protect the battery from further discharge to prevent premature damage to the battery due to repeated cycles at low states of charge.

Maximum permitted depth of discharge (DOD)¹: The maximum permitted charge depletion chosen to prevent premature degradation to the battery.

Nominal power: The designated power of a device either expressed in watts (W) or volt-amperes (VA) and stated on a nameplate

Normal operating (PV) cell temperature (NOCT): The temperature of a photovoltaic cell when subjected to an irradiance of 800 W/m², an ambient temperature 20°C, and a wind velocity of 1m/s.

Watt-peak power (Wp): The maximum power a photovoltaic module can deliver under standard test or normal cell operating conditions in watts.

Percentage depth of discharge²: The amount of charge removed from a fully charged battery at a specified discharge rate expressed as a percentage of the battery's rated capacity.

Power factor: The ratio of the "Real" power (W) to the "Apparent" power (VA).

Rated capacity of a cell or battery: The quantity of electricity, declared by the manufacturer, which a cell or battery can deliver under specified discharge conditions, for example 300Ah at C₁₀ (300Ah in discharged in 10hrs).

Rated Power of an inverter: the maximum power the inverter can deliver at "full-load" conditions

Real power of an inverter: The product of "Real" Voltage and "Real" current, measured in Watts.

Reactive Power: The product of reactive voltage and reactive current measured in AVr

Solar Cell: Is a unit doped silicon wafer which when exposed to the sun-rays, produces a DC current and Voltage

Solar Module: Is unit assembly of several solar cells, to form power generating equipment, whose rating is in terms of Watt-Peak (Wp)

Solar Panel: Is unit assembly of two or more single solar modules wired together in series or parallel for purposes of voltage or current configuration within a solar-PV power system, whose rating is in terms of Wp or "kilo" Watt-peak (kWp).

Solar Array: Is an assembly of a group of two or more solar panels wired together in series or parallel to form a solar-PV power plant, whose rating may be in terms of "kilo" Watt-peak (kWp) or "Mega" Watt-peak (MWp).

¹ Depth of discharge for which the system will shut-down e.g 50% DOD setting for the inverter to load-shed

² The utilization of 30 Ah from a battery fully charged 100Ah is equivalent to 30% DOD

Standby current (of an inverter): Current drawn by an inverter when no load is connected to the output.

Standard test conditions (STC): Conditions where the irradiance is 1000 W/m², the temperature of the photovoltaic cell is 25 °C and the air mass is AM1.5.

3.1.4 Abbreviations

For the purposes of these Technical Specifications, the following abbreviations shall apply:

A.C: Alternating Current

D.C: Direct Current

DOD: Depth of discharge

e.m.i.: Electromagnetic interference

kWp: Kilo Watt-Peak

MCB: Miniature circuit-breaker

NOCT: Normal Operating Cell Temperature (*Irradiance level: 800W/m², Ambient temperature: 20°C, AM1.5 spectrum, wind velocity: 1m/s*)

PV: Photovoltaic

SOC: State of charge

STC: Standard Test conditions (*Irradiance level: 1000W/m², Ambient temperature: 25°C, AM1.5 spectrum*)

SPV: Solar Photovoltaic

SPVP: Solar Photovoltaic Power

Wp: Watt-Peak

3.1.5 Site Conditions and Meteorological Data

All systems and components shall be designed, manufactured, engineered, installed and commissioned in a manner that in their proper functioning, they will withstand the climatic conditions and environment at a designated site during their normal lifetime.

Site conditions: The following general climatic conditions shall apply where necessary:

Altitude of project area above Sea Level (m) :	1041-1200
Ambient Temps:	Max. 45°C and min. 18°C
Seismic Acceleration (g):	0.15-0.28
Isokeraunic Level ³ :	150
Relative Humidity:	Max. 100%, Min 38.8%

³ Number of thunderstorm days per year

Rainfall Average annual (mm):	1000-1200
Hail occurs in storms:	Yes
Maximum wind load (outdoor wind gusts):	50 m/s at 10m above gnd
Annual average value range in the country:	5.6kWh/m ² /day
Air Mass:	AM1.5

Meteorological Data: Each site has a specific set of meteorological data, got from NASA Surface meteorology and Solar Energy (<http://eosweb.larc.nasa.gov/cgi-bin/sse/grid.cgi?>). This information is presented for each water scheme in these specifications.

3.1.6 Specifications of Solar-PV Modules, Panels and Array

3.6.1.1 General Electrical and Mechanical Performance

Only certified Polycrystalline and Mono-crystalline silicon modules are acceptable. The modules should be certified for compliance with the following specifications:

- International Electro-technical Commission (IEC) 61215/61646 - 1993, Crystalline silicon terrestrial photovoltaic (PV) modules - Design qualification and type approval (or most recent edition)
- Uganda standard US-469: Crystalline silicon terrestrial photovoltaic (PV) module – Design qualification and type approval (US-469:2005, 1st edition)
- Uganda standard US-564: Crystalline silicon terrestrial photovoltaic (PV) module – Design qualification and type approval (US-564:2005, 1st edition)

The solar modules to be supplied shall be constructed from high efficiency mono or polycrystalline silicon cells, with cell efficiency of 16% or higher. Crystalline silicon cells and modules to be supplied shall be approved to IEC 61215 standards with an EN-ISO certificate, JCRC-ISPRA 503, PV-GAP, UL listing 1703, NEC 2008 compliant or similar quality type approval. The pertinent conditions are solar irradiance of 1000W/m², Normal Testing Conditions (STC), Normal Operating Cell Temperature (NOCT) of 25°C.

The PV modules shall have a warranty of 25 years on performance and materials, with 10% degradation after 10-years (90% name-plate rated power capacity available after 10-years) and 20% degradation after 25years (80% name-plate rated power capacity available after 25-years).

The entire laminate of the module shall be installed in an anodised aluminium frame for structural strength and ease of installation

NOTE:

- I) The Engineer reserves the right to insist on submission of modules for standard testing of qualification and performance characteristics with respect to these specifications. Performance characteristics established by the methods set out in the above specifications shall be used to verify the output of the modules to meet the system performance requirements.
- II) Each module shall have a unique serial number; inside the module encapsulation (i.e. stickers with serial number are not acceptable). Also to be included within the

encapsulation is the name of the project, name of client and date of manufacture of the solar module.

The acceptable tolerance for all modules supplied under this contract will be 0%/+20% under Standard Test Conditions (STC) as defined in IEC 60904-1. This means that none of the PV modules can have an actual peak power output lower than the specified rated value. The modules to be supplied shall comply with or even perform better to the following temperature coefficients:

- αP_{mpp} : -0.6%/°C
- αV_{mpp} : -100mV/°C
- αI_{sc} : +2mA/°C
- αV_{oc} : -100mV/°C

3.6.1.2 SPV cells in each module

Each module shall be assumed to deliver nominally 12VDC or 24VDC with a maximum power DC voltage of minimum 17.0V or 29.0VDC respectively.

Modules shall be suitable for operation in high temperature environment. The minimum number of series-connected cells in each mono- or poly-crystalline module shall be 36 cells for 12VDC modules and 72 cells for 24V modules.

3.6.1.3 Terminal connection box

Each module shall be provided with weatherproof terminal connection box(es) to IP54 rating, with robust screws of metallic composition. Plastic screws are not acceptable.

3.6.1.4 Bypass diodes

Bypass diodes shall be installed to prevent hot-spots in modules, which occur often as a result of partial shading of modules. Built-in bypass diodes ensure peak system performance

Every module in a series configuration of 24/48V or higher nominal voltage shall include bypass diodes in the module terminal-connection box. The diodes shall be replaceable without replacing the module or module junction box.

3.6.1.5 Labelling and marking of PV Modules

The SPV Modules shall be clearly labelled and permanently marked with a data plate containing the following information:

- manufacturer's name and physical address;
- type/model number;
- serial number;
- the watt-peak power rating at STC
- Open circuit voltage and short circuit current
- Voltage and current at maximum power point

- Tolerance and temperature coefficient
- the date of manufacture and country of manufacture
- Certification, e.g: JCRC-ISPRA/UL listing/PV-GAP quality certification to IEC 61215,ISO certification

The module terminals shall be clearly marked as positive (+) and negative (-) so as to avoid reverse polarity problems.

For the specifications documents of the solar-PV modules, an I-V graph or characteristic shall be included, to show the performance of the said module type in varying irradiance conditions, as well as varying temperature conditions.

NOTE: For purposes of this contract, solar-Pv modules shall be specifically marked in way that, the serial number, model number, the date of manufacture, the name of the project and the name of the employer shall be clearly visible, embedded within the encapsulation of the module or engraved on top with indelible (non-erasable) marks.

3.6.1.6 Mechanical properties

The frame of the SPV modules to be supplied shall be made from corrosion resistant anodized aluminum alloy to ensure dependable performance even under harsh weather conditions. Pre-drilled holes for fixing of modules onto the mounting frame with bolts shall be provided for ease of installation.

3.6.1.7 Bolts and nuts for fastening solar modules

The bolts and nuts or screws to be used to fasten the solar modules on to the mounting rack shall be of the secure type (theft inhibiting screws), which prevent (or make it very hard) theft of solar modules. The nuts should be self-ceiling or require a special key to open them. This ensures maximum security in that an unauthorized person does not just open the bolts and take away the modules.

Example of a theft-inhibiting screw:

The upper screw head part detaches at a defined tightening torque of 18 Nm \pm 10% thanks to predetermined breaking point introduced through the CNC-processing of the form of the screw head. The lower part of the screw thus offers no sufficient working surface for customary hand tools. The breaking point is designed in such a way that the remaining head part has sufficient stability against shearing off on its part and the tensile strength of the entire screw remains essentially unimpaired.



Technical specifications

Designation:

Commercial name: secur - screw
Safety screw with head modified by CNC processing

Version 1:

Cylinder screw with internal hexagon in accordance with EN ISO 4762 with modified head in accordance with drawing
Standard M8
Standard lengths: 16, 20, 25, 30, 35 mm

Version 2:

Raised countersunk-head screw similar to DIN ISO 2010 however with external hexagon drive 6 mm
Standard M8
Standard lengths: 30 70 mm, 5 mm upwards

Quality:

Rust and acid-resistant austenitic steel A2 in accordance with ISO 3506; standard strength category A2-70
Tensile strength $R_m = 700 \text{ N/mm}^2$ ¹
0.2% Yield point $R_{p0.2} = \text{N/mm}^2$ ¹
Breaking elongation $A = 0.4d$

Thread:

Execution in accordance with EN ISO 4753:2002
Tolerances: average in accordance with EN ISO 965-2:2001

Assembly Separation torque:

18 Nm \pm 10% ²

¹ Values refer to a cross-section of the stressed area of the thread
² Applies only to the quality A2 - 70

3.1.7 PV Module Installation and Accessories

3.1.7.1 PV module interconnection

Wiring shall be permanently shaded from UV radiation. Wiring shall be 'Flexible multi-strand copper conductor cables in flexible UV resistant (e.g. Neoprene) sheath compatible with gland seals', with any array junction boxes as may be required.

The arrangement of modules on the structure, and their interconnection is designed to enhance servicing and inspection:

- 24V modules will considerably simplify array wiring. Modules shall first be connected in series strings of individual modules to achieve the desired nominal voltage (ie only if 12V modules are used), and these strings shall be paralleled to develop the required peak current. For modules connected in series, connections from each module shall be looped from one module terminal-connection box of one module to the next
- No more than one cable per gland shall be allowed unless conduit is used, and the cable/conduit entries shall be watertight.
- When modules or strings of modules are thereafter connected in parallel, practical wiring constraints require that at least one array junction box is used, and modules/strings at the correct voltage are connected to the array junction box.

3.1.7.2 Blocking diodes

A blocking diode assembly is required only if the regulator requires blocking diodes. If they are required, then blocking diode assemblies complete in array junction boxes shall be supplied.

3.1.7.3 Array junction box

Each series string of modules of an array of three or more parallel strings of modules shall be individually connected to a weather-proof array junction box (IP 54).

The junction box shall be capable of dissipating the heat generated by the blocking diodes (if installed). The array junction box shall be to IP54 rating. The junction box shall be provided with internal DIN-rail type electrical connectors. The terminals shall be clearly labelled positive or negative/DC-IN/DC-OUT. The type of wiring and arrangement of wiring within the junction box should facilitate maintenance and inspection of connections. There shall be one full loop within the array junction box, for each incoming and each outgoing cable.

Junction boxes must be accessibly, securely and squarely mounted on the array structure, out of easy access range of tampering and whenever possible in the shade of the PV array.

3.1.7.4 Voltage configuration for Solar Panel (sub-array)

A voltage configuration of 500-650VDC, or higher as appropriate [with reference made to inverter/controller input DC voltage requirements] shall be used for construction of a sub-array.

3.1.8 Module or Array Mounting

3.1.8.1 Structure Assembly

The array support structure as illustrated in figure 3.1 below, shall be fixed (non-tracking), after installation. The tilt angle to the horizontal must be in the range between 10o to 15o after installation on the relevant location.

The structures shall withstand wind speeds of 120km/hr. The structure shall be ground mount and all materials used with the associated standard of works, shall comply with the specifications for rust-free/corrosion resistant metal works.

The structure shall be corrosion resistant galvanized steel, hot-dipped galvanized to thickness in SANS 12944:1-8 (SABS ISO 12944:1-8 (1998)). Any required welding, holes drilled or damage to the structure after galvanizing shall be repaired with Galvadip™, Adensotape™ or Petrotape™ systems, or other approved substantially equivalent cold-galvanizing treatments.

The structure shall accommodate such conduit or trunking and any array junction boxes as may be required to meet the specification requirements for module interconnection as required in Section 3.1.4 above

The structure and mounting arrangements shall be compatible with the earthing/grounding requirements as required in Section 2.2.8 above

Each panel shall be attached to the structure in four places as provided on the panel, and the panel shall not itself form part of the support structure, to prevent torsional forces on the panel.

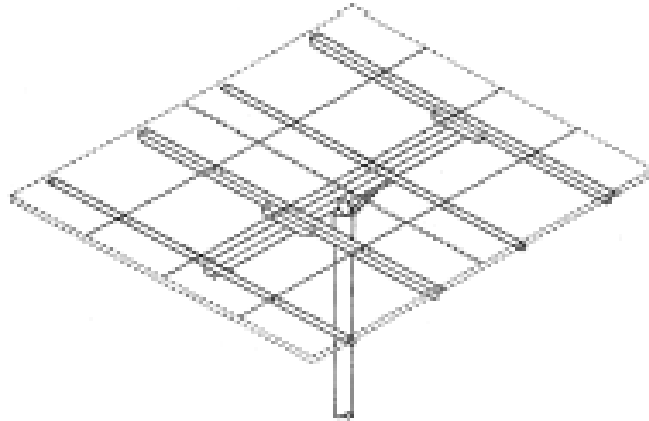

Figure 3.1: solar array mounting rack

The contractor shall supply all necessary nuts, bolts, washers etc. for mounting the array to the super-structure, and for mounting the super-structure to the roof or vertical pole as may be applicable.

- All nuts, bolts and washers shall be stainless or galvanized steel, and any other mounting material shall be of corrosion resistant material.
- The bolts for fixing the modules onto the structure should be stainless tamper-proof bolts.

3.1.8.2 Expansion possibilities

The structures shall have space to accommodate at least additional 1kWp 24V of array, as may be necessary for increased energy needs and expansion to a more comprehensive energy system in future.

3.1.8.3 Roof-mount option (on solar building)

This option shall be used for auxiliary lighting PV-system installations. The structure shall be mounted onto the roof of the pump-house

Roof mount structures shall be made only of hot-dipped galvanized steel. The selected array tilt angle shall be fixed after installation, to ensure that the minimum tilt angle can be obtained on any roof type or slope. If it is necessary to assemble the structures themselves using bolts, then only tamperproof bolts shall be used that cannot be easily undone by potential vandals.

The attachment of the Roof mount structures to the building shall use tamper-proof through-roof J-bolts attached to the purlins. Simple screws to the rafters are not acceptable.

Detailed drawings of mounting structures shall be submitted. The Tender is responsible for ensuring that the proposed roof-mount array roof structure is compatible with the pump house.

3.1.9 Installation of Array Structure

3.1.9.1 Orientation and tilt of the PV array

The structure shall be orientated to the south, although this might not be critical. The installer shall note the deviation of magnetic north from true north. The array shall tilt at least 10-15 degrees and not more than 15 degrees from horizontal, to allow water and dust to freely wash off the array. The figure 3.2 below shows the tilt and orientation of solar array for both roof mounted and ground-mounted arrays.

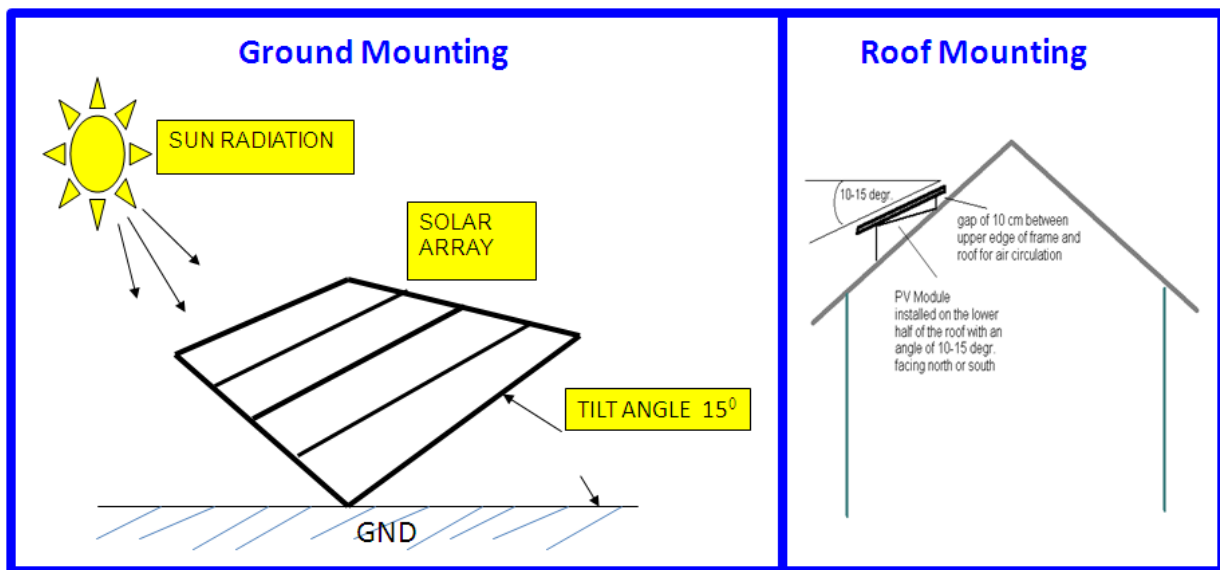

Figure 3.2: Tilt and orientation of solar arrays

3.1.9.2 Selection of the PV array site

The structure and location shall allow an unobstructed solar view; there shall be no shading on any part of the array at any time of the day, in any season. The lowest part of any module from the roof shall be close to the roof, to reduce wind exposure. Consideration should be given to possible future shading by vegetation growth (e.g. the position of young trees) over the system lifetime.

Wherever modules are mounted, they shall be accessible for cleaning on a regular basis. However, array Junction box to charge controller cable lengths shall be maximum of 5 meters one way.

Array mounting rack All parts of the mounting structure shall be engineered for wind resistance, ease of adjustment, safety and must be corrosion resistant. All metal parts shall be made of rust-resistant material or shall be appropriately painted so as to make such metal parts rust-free.

All the metal parts used to make the mounting rack shall be of the appropriate tensile strength and can withstand the load impact from the solar modules and any other environmental hazards like wind and storms.

Concrete base The concrete base supporting the solar array in ground shall be made from high quality cement, sand and coarse aggregate, water as appropriate and well mixed and brought to the proper consistency, as required by the standards of international practice of section 2.20.

Support Stand The array support stand shall be made from steel material (well painted, rust and corrosion free), from well-constructed brick supports, or equally approved material in accordance with the prevailing mechanical and civil-works standards. Care must be taken such that the array support structure is strong enough to carry the array even in hazard (wind/storm) situations.

NOTE: *The spacing in between the solar panels making up the array shall be appropriate, about 1m, so as to prevent shadowing of any kind from the panels themselves. This also allows for good air circulation within the array, hence preventing heat build-up.*

Clearance from Ground: An appropriate clearance of array from ground shall be allowed for so as to prevent interference with the solar modules as a result of running water, vegetation and insect habitat build-up. This also allows for good aeration of the array structure.

3.1.9.3 Quality of installation

Ground Mounting structure: Ground mount structures shall be designed and constructed with reinforced concrete as specified in sections 2.20 and as shown in the appendices

Roof mount structures: Roof mount structures shall be attached to purlins using through-roof J-bolts. J-bolts to penetrate roof only on high point of corrugations, and to use sealed compression glands on both inside and outside to prevent leakage.

Alternatively, anchored threaded studs to be drilled to maximum 10mm (do not understand 10mm) so as not to pierce roof shield, and cause leakage.

Repairing damage made: Any surface damage to galvanizing shall be treated with either Galvadip™, Adensotape™ or Petrotape™ systems, or other approved cold-galvanizing treatments.

Any holes made in the roof material shall be sealed and made waterproof with approved UV resistant material.

Array junction box and wiring: The array junction box must be mounted squarely and accessibly on the array mounting structure.

Wiring shall be UV resistant and should be shaded where possible, or protected with UV-resistant or painted conduit.

Array structure earthing: PV module frames and array structures shall be properly earthed in accordance with specifications of Section 2.2.8

3.1.9.4 Solar array (PV) disconnect switch

For PV-direct systems, a two-pole disconnect switch must be installed between the solar array and the controller. The loading of the switch shall not exceed 70% of the nominal capacity-this will allow for system expansion. The switch shall comply with relevant clauses of the IEEC/IEC and UNBS standards for DC electrical systems.

3.1.9.5 Electrical wiring

All electrical wiring shall be in accordance to the IEC/IEE and UNBS standards for Photovoltaic systems. Specific clauses of US152: 2000 sections 4.0 and 5.0, shall respectively apply to all DC-wiring requirements, including all cabling, terminations and voltage drops. A voltage drop exceeding 3% of nominal supply voltage across each input/output system component shall not be permissible.

3.1.9.6 Cables and Interconnections

[a] Cables

All cables shall be UL type TC, 600V, 90°C with PVC sunlight resistant jacket and include corrosion resistant, non-metallic, liquid-tight cable strain relief connectors or approved UNBS/IEC equal, with overall lengths pre-sized for best appearance.

Two-wire cable assemblies are red and black conductors used for 12V system parallel connections on 24V or 48V systems. Three-wire assemblies red/black/blue conductors used for 24/48V series/parallel connection of the last module in a 4-panel assembly. Four-wire assemblies red/yellow/blue/black used for 415VAC 3-phase system.

[b] Submersible cable

Use of a good grade of 4-conductor submersible pump cable is recommended. Each wire must be sealed 100% water-tight. A high quality, waterproof connection between the pump wires and supply cable is very important. Electrical cable tables can be used to select the appropriate cable size for use with respect to the distance, voltage and current values involved.

[c] Interconnections

An important part of the system wiring is proper module connection that exhibits the highest degree of reliability and performance in severe climates and environmental conditions.

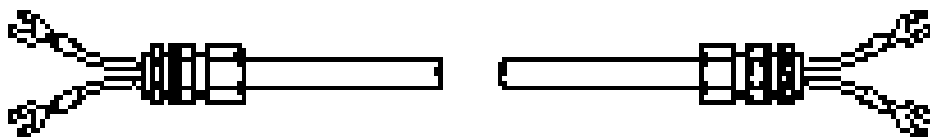

FIG.3-3: Cable Interconnects

All such interconnections shall be pre-assembled, featuring tin-plated copper fork terminals for stud, crimped and soldered to AWG stranded copper wire with adhesive “melt-wall” shrink tubing heat sealed over the crimp connection or an equally approved interconnection. The figure 3.3 above illustrates a standard module interconnection accessory.

3.2 Specifications of Pumps for water abstraction

3.2.1 Ground Water Pumps

The borehole pump shall be of submersible-multistage-centrifugal type, made up of an AC motor constructed from high grade Marine Bronze and 304 Stainless steel or approved equivalent metal material. It shall be constructed with a multi-stage centrifugal pump end. All metal material used for pump construction shall be corrosion resistant, permanently lubricated and maintenance free.

For solar systems, a water pump equipped with a variable frequency/speed induction motor is highly recommended.

3.2.2 Surface Water Pumps

Surface water pumps shall be used for abstraction from surface water sources. The pump shall be made up of an AC motor constructed from high grade Marine Bronze and 304 Stainless steel or approved equivalent metal material.

The impellers and diffusers shall be constructed from a rugged thermoplastic or approved equal material, and shall be extremely resistant to mineral and algae deposits.

3.2.3 Motor end

The motor end of the water pump shall be constructed with the following features:

- 3-phase 415V AC motor (50Hz speed controlled, +5hz selectable speed)
- corrosion-resistant, all stainless steel exterior construction
- stainless steel splined shaft
- NEMA mounting dimensions
- hermetically-sealed windings
- water lubrication
- pressure equalizing diaphragm
- maximum water temperature: 30°C, PH value of water : 6-9

3.2.4 Pump end

The Pump end of the water pump shall be constructed with the following features

- centrifugal multistage direct-coupled pump end
- non-return valve
- material: stainless steel (AISI 304), rubber

- dry running protection (a must)
- Able to withstand maximum sand content: 50 g/m³, a higher content will wear the pump and reduce its life span considerably
- Able to withstand maximum salt content: 300-500 ppm at max. 30°C, higher salt contents require lower water temperatures
- Water pH value: 6-9
- high life expectancy and very low maintenance requirements

3.3 Specifications of Power inverter and Pump drive for solar-PV water pumping applications

3.3.1 Inverter manufacture

The Power inverter shall be used to convert DC power from solar-PV modules to AC power that can be used to power an AC-motor based water pump. The inverter shall act as a Pump drive or controller made from IGBT power electronics, manufactured and supplied to work with the specified pump type, and universally works well with induction motors; suitable for solar water pumping applications.

The inverter shall be designed to provide convenient information about voltages, switch and sensor status, and overload conditions; and provide maximum power [maximum power point tracking and current boosting] under varying conditions.

Other features include:

- controlling of the pump system and monitoring of the status of system operation
- Has two control inputs for well probe (dry running protection), float or pressure switches for remote control. With automatic reset 20 minutes after well probe turns pump off
- Data logger for historical dates: running time, starting/shut down time of day, maximum power/voltage of day, accumulated energy of day.
- Display of current running data such as: input/output current/power/voltage, pump speed, temperature speed control selectable, maximum and minimum speed
- Solar operation: integrated MPPT (Maximum Power Point Tracking)
- Input power: maximum Voc 750 VDC, Operating Voltage range V_{mpp} 500-650 VDC for 3-phase systems
- Output power: 380-400-415 VAC 3-phase, 30-60 Hz
- Maximum efficiency 97 %, advanced IGBT power electronics technology
- Inverter enclosure: IP 41 (sealed, weatherproof, insect proof, lizards' proof)
- Ambient temperature: -10 to +45°C

- Remote sensing capability with ability to store and retrieve data via Web/USB/RS232/SD-Card

3.3.2 Nature of system control unit

The Inverter recommended shall be that, which simplifies system control, and troubleshooting of the pumping system. The control algorithm shall be user friendly and requires minimum or no programming by the user, that is, self-programming and self-diagnostic operation; suitable for solar-PV water pumping applications.

Inputs shall be provided for remote switches and water level sensors [full-tank shutoff and Dry-run well sensor]. LED indicators or LCD displays shall be used to provide information about voltages, switch and sensor status, and overload conditions.

3.3.3 Input-Output Voltage capacity

The controller/Inverter shall be able to accommodate a wide range of varying DC voltages (maximum-power point value) between 300-650VDC, with 200-240VAC single phase or 380-400-415 VAC-3 phase power output. The inverter shall be able to work with a change-over switch for purposes of hybrid-energy systems using diesel generator as an alternative source of power.

3.3.4 The Inverter unit

The inverter to be used for DC-AC conversion shall meet all applicable IEC, UL, IEEE and NEC standards. It is referred to as a variable speed DC-AC inverter, with pure sine wave output power. Its automatic operation shall include but not limited to start-up, shutdown, self-diagnosis and fault detection. It shall have a Maximum Power Point Tracking (MPPT) technology algorithm so as to maximize PV-array output.

Table.3-1: Specific Parameters for the power inverter for solar water pumping applications

No.	Parameter	Requirements
1	Input type	DC power from solar panels
2	Input DC Voltage (maximum power-point –MPP values)	500-650VDC
3	Power Output level	3-phase
4	Output voltage	380-400-415VAC Pure sine-wave
5	Frequency	50Hz (+5Hz selectable speed increase) variable speed
6	System Control	Digital signal Processor, with unity power factor control
7	Power control	Maximum Power Point Tracking at near Unity Power Factor
8	Motor control	Variable speed/frequency control
9	Auxiliary controls	Full-tank shutoff and pump dry-run protection

10	Remote sensing and Data storage	Remote sensing via web using GPRS GSM technology, including data storage and retrieval via web/USB/RS232/SD-Card techniques
11	Warranty	5-years

A stand-alone inverter unit for this purpose shall have in-built inverter, isolator transformer, AC disconnect switch, and DC disconnect switch, Combiner box and DC 750V fuses. IGBT switching capability should allow for the inverter to supply variable frequency power for the variable speed operation of the water pump.

The inverter unit shall have 99% peak efficiency and total efficiency including transformer losses, in excess of 98% at “near unity” power factor and full-load conditions.

Additional feature required include, surge protection, over voltage and overload configurable run parameters, with digital signal processor control; remote monitoring accessories suitable for solar-PV water pumping applications. The remote monitoring accessories to accompany the inverter shall include the well probe, digital flow meter, liquid pressure sensor, liquid water level sensor, sun sensor and communicators with GPRS enablers

3.4 Grounding and lightning surge protection

3.4.1 *Grounding and bonding*

All the structural components and electrical enclosures shall be bonded together to a common earth connection. When connecting dissimilar metals, connectors that are approved for the materials involved should be used. (Example: at the aluminium framework of the solar array, connectors labelled “AL/CU” are used).

3.4.2 *Earth connection*

An effective discharge path for the surge should be created. One or more 8-foot (2.5m) copper-plated ground rods, preferably in moist earth, should be installed. Where the ground gets very dry (poorly conductive), #6 (16 sq. mm) or double #8 (10 sq. mm) or larger bare copper wire shall be buried in a trench at least 100 feet (30m) long. Connection to one end to the array structure and controller should be done or, the ground wire should be cut in half and spread in two directions. The figure 3.4 below shows how grounding and lightning protection can be implemented on a solar-PV site.

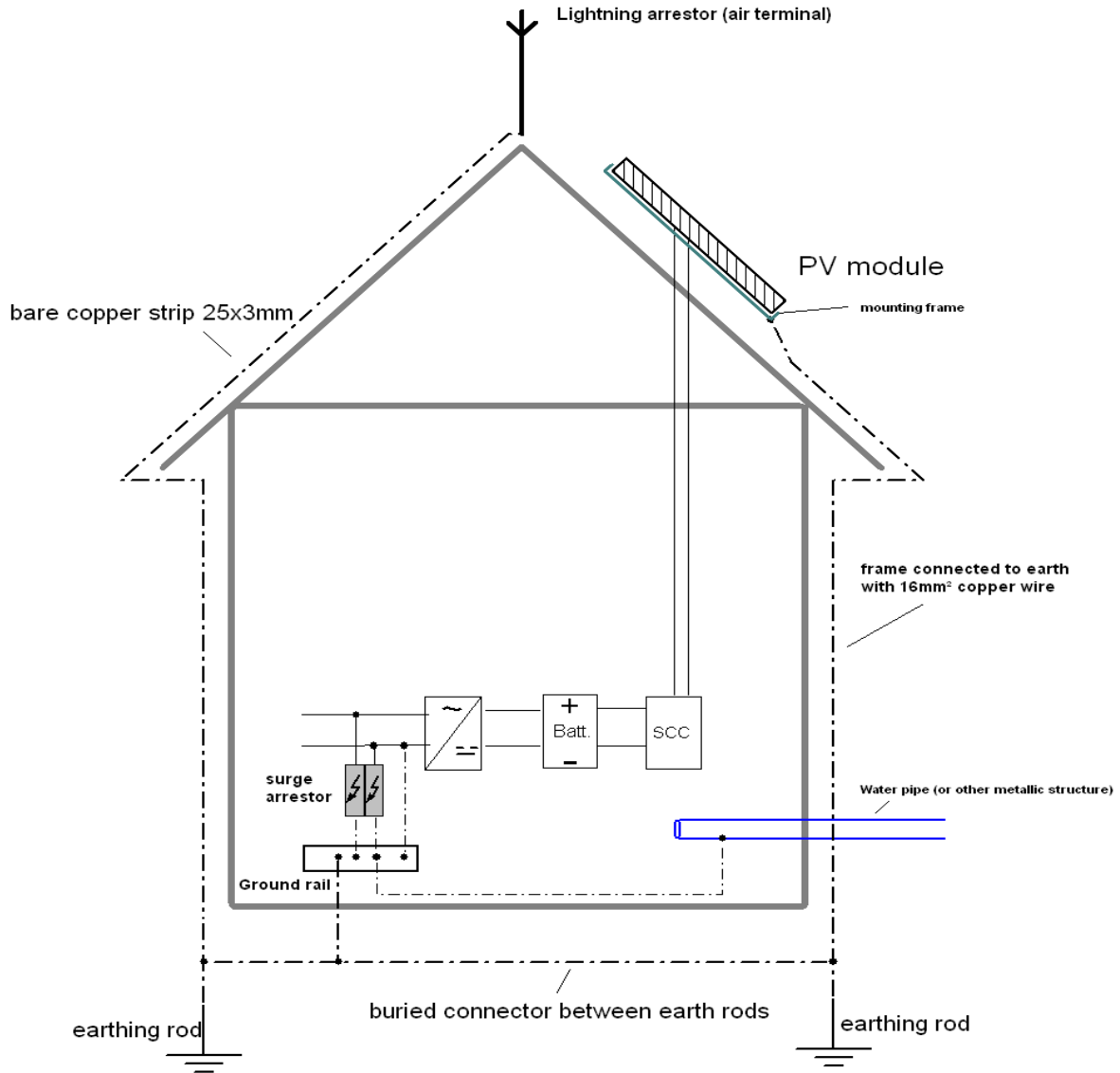

Figure 3.4: Equipotential bonding for grounding and Lightning protection for a solar-PV site

3.4.3 Grounding the pump

The ground wire shall be connected to one of the ground connections in the controller, or to the controller enclosure. Grounding helps to prevent shock hazard if there is a fault in the motor.

Additional grounding measures or surge protection devices are recommended under any of the following conditions:

- Isolated location on high ground in a severe lightning area
- Dry, rocky, or otherwise poorly conductive soil

- Long wire run (more than 100 feet / 30m) from the controller to the pump, or from the controller to the float switch.

3.4.4 Lightning Protection

The lightning arrester and associated equipment supplied for this purpose shall be in accordance with the IEC/IEE regulations. The external and the internal protection require a good earthing system to evacuate the lightning currents, and equal potentiality within the earthing system, both of the protection system and of the electrical circuits to be protected.

Lightning arrestors of type Fast response Silicon Oxide Varistor in potted PVC case may as appropriate be used or copper arrester with the copper tape and ground rod are recommended for use.

3.4.5 Surge protection

For the electrical system has to be implemented by using a single-pole surge arrester with rated line-neutral operating voltage of 275Vac, voltage protection level at 5kA is 1kV, with 25ns response time; certified to IEC 61643-1 standard. The surge arrester system is implemented as shown in the diagram in figure 3.5 below in accordance with E DIN VDE 0675-6:1989-11, -6/A1:1996-03, and -6/A2:1996-10 standards.

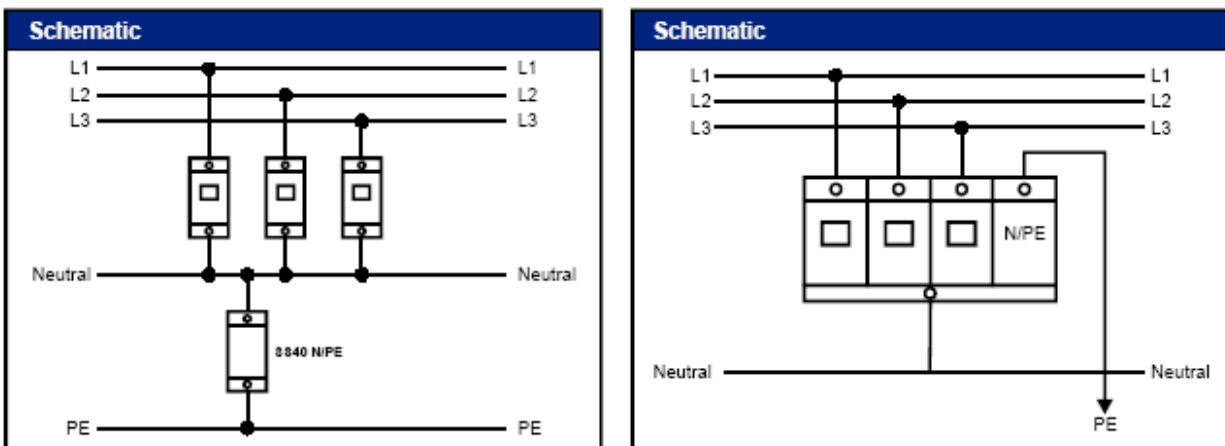

Figure 3.5: Surge protection system for inverters pumps and solar arrays

3.5 Other Balance of System equipment

3.5.1 Wellhead assembly for borehole wells

The well seal is a plate that fits on top of the well casing. It shall be used to provide a seal against contamination of the well, and it supports the weight of the in-well assembly.

Use of metal pipe components above ground, for strength is recommended. A tee and a plug shall be used instead of an elbow, because the plug allows direct observation of water level and flow. It also provides a place to attach a lifting device.

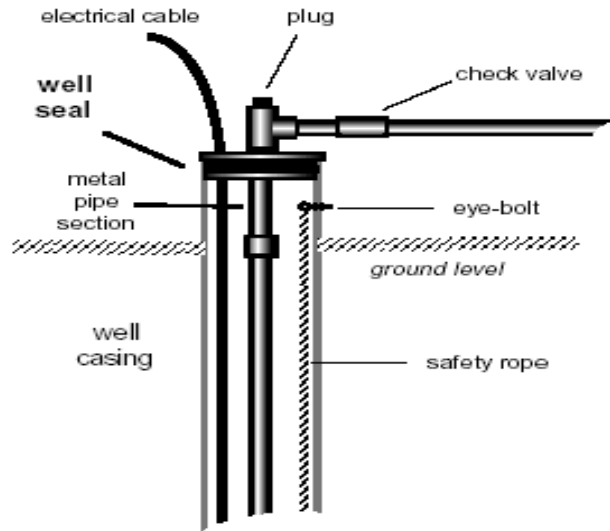

Figure 3.6: Well head assembly

3.5.2 Automatic Control for Full-tank shutoff

It is recommended to use an automatic Float Switch or other means to prevent overflow of water storage tank. This accessory shall be used to stop the pump when the tank is full, then reset when the level drops. This conserves ground water, prevents overflow, and eliminates unnecessary pump wear.

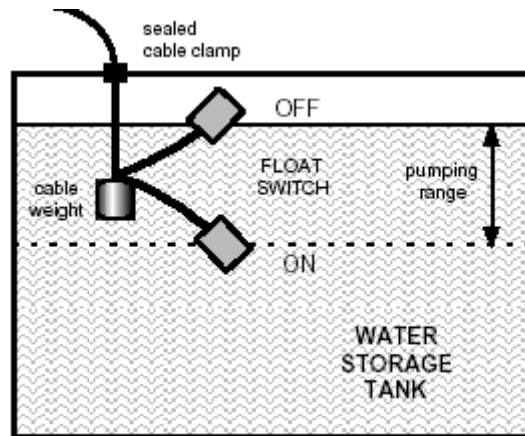

Figure 3.7: Full-tank shutoff Float Switch

Figure 5-4 above shows a fully installed “full-tank shutoff” float switch, the Float Switch Kit shall include float switch, cable, cable weight and cable clamp.

3.5.3 Well Probe for dry run protection

The purpose of the well probe is to sense the loss of water just above the pump, so that the pump will shut off and not run dry. Running dry damages the pump. The submersible pump supplied shall be installed with this accessory included. It shall be made from corrosion free and algae resistant material.

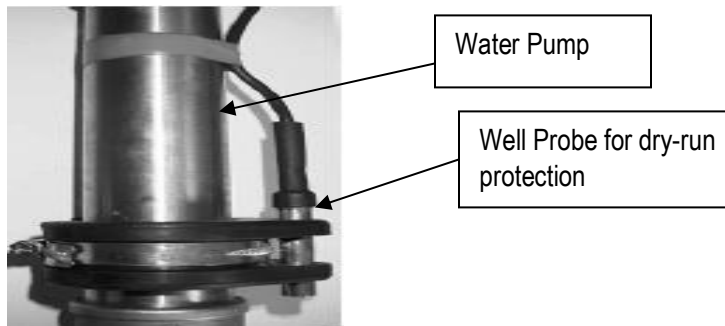

Figure 3.8: Well Probe for dry run protection

Dry-run protection monitor (optional): Electronic device that provides for monitoring of current, voltage and motor temperature using three integrated current transformers. A digital display provides current and voltage readings for all three legs and allows the user to set up the monitor quickly and easily. Data can be downloaded to a PC.

The monitor can protect the pump against adverse conditions such as low-yielding wells, pump damage, clogging, bound pumps and power mishaps. It is designed to protect three-phase motor and pump systems with ratings between 3 and 200 hp with 3 seconds response time. An example of such a monitor is the Franklin Electric “SubMonitor”.

3.5.4 Draw Pipe

Larger pipe sizes shall be used to reduce friction loss on long horizontal runs. Larger sizes shall be avoided in vertical runs because sand in the water may settle and cause blockage. Smaller sizes should not be used because of high friction losses. Plastic pipe is preferred for all pumps because the smooth surface of the pipe reduces friction losses and also provides a cushioning effect.

3.5.5 Sand Shroud

This device is used when dirty water conditions are experienced. The sand shroud eliminates destructive sand intrusion and is constructed of rugged PVC and Polyethylene for long life.

3.6 Auxiliary Lighting System

3.6.1 Auxiliary Lighting System Capacity

The Auxiliary solar-PV lighting system will feature the following components as per below configuration

Solar-PV	Charge controller	Battery	Inverter
2x295Wp	1x20A	24V; 200Ah (2 number batteries of 12V,200Ah)	1x1000Wp (24V)

3.6.2 General requirements

The auxiliary solar lighting system shall be designed and installed to provide general lighting for the whole site; as well as providing power supply to the alarm system.

It shall be based on Direct Current (DC) generated from solar-PV modules, which is then converted to Alternating Current (AC) using a DC-AC inverter. This solar-PV system installation shall be standalone and completely independent of the solar-PV water pumping installation.

It shall consist of a solar module, power controller, battery, lights and cables supplied and completely installed according to the relevant clauses of the following standards:

- UNBS US152: 2000, Code of Practice for installation of Photovoltaic Systems,
- UNBS US. 149-1:2000 Batteries for Photovoltaic systems
- UNBS US-147: Requirements and Specifications for Photovoltaic Systems

All the main equipment, that is, solar modules, controller, batteries, and lights, should have the Accredited Testing Laboratory PV Quality Mark. This quality mark provides the assurance that an Accredited Testing Laboratory has tested the equipment to IEC 61215 or IEC 61646, and that the manufacturing has ISO 9000 certification and periodic auditing.

3.6.3 Photovoltaic Modules

The solar modules to be supplied and the overall solar-array installation shall be in accordance with the relevant clauses of section 3.1 and 3.2 above.

3.6.4 Solar (PV) array disconnect switch

The PV disconnect switch supplied for use with PV systems shall bear manufacturer's PV quality mark, PV GAP, UL or any other accredited testing laboratory PV Quality mark. The fuses shall be appropriately sized (defined as $1.25 \times I_{MAX} @ STC$) for fault protection, arising from the array.

3.6.5 Power Controller/Regulators

The power controller or regulator refers to the complete charge/discharge regulator system unless specific reference is made to the separate parts. It shall be used for purposes of controlling charging and discharging of Battery.

Compatibility: The regulator shall be compatible with the particular batteries offered for optimal battery cycling life. The regulator function shall protect the battery from over-charging and over discharging.

Charge control: The regulator to be supplied shall have the multi-stage (boost/float) method of charge control as required for flooded batteries.

The load-shed settings shall be dependent on the battery type specified, load and system design. The Engineer prior to approval shall confirm set points.

Voltage set-points: The voltage set-points shall be adjustable in the factory before dispatch. The voltage set-point adjustment applies particularly to load-shed disconnect and load-shed reconnect set-points. This is critical to ensure that the 'dual-priority load-shedding' and subsequent reconnection occurs in the intended manner. Load shedding shall be set at maximum battery DOD of 60%.

Protection: The regulator shall be protected against the following electrical occurrences:

- Over-voltage conditions if the battery is disconnected,
- Lightning induced surges, with protection either internal or external.
- Regulators shall be mechanically robust and corrosion proof.
- Reverse polarity protection is desirable

Efficiency and energy consumption: The charge regulator energy efficiency shall be high under all operating conditions. The energy loss through the charge regulator from the array input to the battery terminals of the regulator rated current shall not exceed 3% of the nominal input value during system operation and load shading.

Instrumentation, indicators and signage: The charge regulator shall incorporate the following visual indicators:

- An indicator to show that the battery is being charged by the PV array.
- An indication of whether the charge is a boost or float charge.

The load-shed regulator/s shall incorporate

- A time delay or integrating circuit to prevent low voltage indication or load-shedding during momentary voltage sag due to motor starting or other high current starting loads.
- An indicator showing if the battery is half-full (with load-shed being the next event)
- A load-shed indicator to show when the regulator is in load-shed mode due to low battery voltage
- Automatic reconnection of the load to the battery after the battery has recovered following load-shed.

3.6.6 Battery

Two lead-acid battery types are considered in this specification. They are listed in the table below:

Type	Particulars	Remarks
1	Deep-cycle tubular plate, sealed batteries with either gel or immobilised electrolyte [life is 6-8years]	<ul style="list-style-type: none"> • Sealed batteries can be installed within the pump house, as they release no gases. • They require very low maintenance. • Require careful charge control, especially at variable ambient temperatures.
2	Moderate-cycle, flat plate, sealed, batteries with either gel or immobilised electrolyte [life is 4-6 years]	

Note that the battery capacities specified in this tender are given at the C10 rate, or the 10-hour discharge rate at 20oC. (Batteries for solar application are often rated at the 100-hour discharge rate at 20oC, as well as at the 10-hour rate.).

The following standards shall apply:

- IEC 61427-1 Standard: Secondary cells and batteries for solar photovoltaic energy systems – General requirements and methods of test.
- IEC 62093 Draft standard: Balance of system components for photovoltaic systems _ design qualification natural environments.
- NF C 58-510 Standard: Lead-acid secondary batteries for storing “photovoltaically” generated electrical energy.

Installation: Installation of batteries shall be in accordance with the relevant clauses of US152: 2000 and IEC standards listed above.

3.6.7 Interior and Exterior Luminaires

All such Luminaires supplied for the auxiliary lighting purpose shall be 240VAC compatible, with up to 8000 lighting hours.

All lamps shall be compact fluorescent type (CFL's), whether integral or separate units, shall be of high efficiency rated a minimum of 550 lux and 60 lumens/watt at 240VAC and 20oC.

All lights supplied shall be in accordance with the relevant clauses of the US 152:2000 and IEC standards. 15W 240VAC lights shall be used for exterior lighting while 11W-240VAC shall be used for interior lighting.

Each system shall include the number and type of lamps indicated in Annex 5 and Annex 6. Lamps are to be installed, or customers instructed to locate the lamp in a location that provides the maximum benefit to the user. Lamps should optimize the amount of useful light projected on the illuminated area by use of high efficiency reflectors, fixture shape or other appropriate means.

Lamps should also be installed in such a way that the fittings do not produce glare and also the space to mounting height ratio (SHR) of about 1 to 1 is maintained assuming a working bench height of 0.85m. Where necessary the lamps should be suspended using standard light pendants consisting of a lamp holder and a white flexible cable so as to achieve the required SHR.

Lamps shall be capable of continuous operation under voltages ranging between 90% and 120% of nominal voltage. Minimum operating voltage when the tube will start shall be at least 90% of the nominal rated voltage. Under 90% to 120% of the rated voltage, compact fluorescent lamps must provide a minimum lifetime of 6000 hours. The switching lifetime (on/off cycles) must be at least 4000 cycles.

Luminous efficacy requirements:

- a) Under rated voltage, the luminous efficacy should not be less than 60L/W without cover and reflectors, after 100 hours of conditioning, and at an ambient temperature of 25 degrees Centigrade.
- b) The luminous efficacy should not be less than 80% of its rated value throughout a voltage range 90% to 120% of nominal value.

Lamps should be marked with the manufacturer; model number, rated voltage and wattage.

3.6.8 System installation

System installation including Photovoltaic modules, Power controller, Batteries, Wiring and cables, Switches, Power points, and Light fixtures shall be done in accordance with the relevant clauses of US 152:2000, DUS: 147, and IEC regulations for DC electrical wiring.

3.6.9 The DC-AC inverter

The following parameters shall hold over the entire range of operating voltage and loading ranges:

- The nominal RMS voltage per phase to be 230 V AC \pm 5% at a input voltage range between 90% and 120% nominal input voltage-with pure sine wave out.
- The output frequency shall be 50Hz \pm 5% pure sine-wave.
- Efficiency not less than 95%.
- Operate safely for at least one minute at 125% of rated power.
- Provide at least 200% of rated power for at least two 2 seconds
- The output waveform total harmonic distortion should be not more than 3%. The inverter supplied should be of the transformer type.
- The maximum quiescent current draw of the inverter, when no LEDs are illuminated, must not exceed 3% of the rated input current of the inverter.
- Quiet operation: The noise produced by the inverter should be no more than 65dB at a distance of 3 meters from the inverter.

The inverter shall be protected against failures due to:

- over-load; low battery voltage
- over-temperature condition
- output short-circuit
- reverse input polarity
- Lightning induced transients when use in lightning-prone areas is expected.

The inverter shall clearly indicate at least the following conditions:

- on / standby mode
- over-load / output short-circuits
- low battery voltage

The inverter input and output terminals must not be exposed to contact by the user and must be securely mounted in a location which is not accessible by children.

Each inverter must be labeled with the minimum information:

- Manufacturer name and model, Serial number
- Input and output voltage and rated power
- Battery and load connection points and polarity

Complete documentation for the inverter must be included in the service technicians training manual and should include:

- Installation instructions, Operating instructions
- Safety warnings, Troubleshooting instructions
- Information pertaining to serviceable parts; and Warranty

The contractor shall submit in the technical bid manufacturer's specifications and other relevant information to support the listed specifications for the inverter as proof of compliance.

3.6.10 AC System Specifications

Though the solar system pre-dominantly produces DC power, for universality of loads and ease of operations, the Client recommends AC power for all sockets and lamps. Hence, an inverter has to be employed to convert DC to AC power; and as such, all house wiring has to be of AC-standard.

AC wiring and circuit protection

- The AC output of the inverter must terminate in a distributor board or junction box.
- The AC output of the inverter must be protected by a surge protective device (SPD) with V_{max} 275V AC 50Hz, 2x40 KA 8/20 μ s. The SPD has to be mounted in the distributor board and have a direct connection to earth.
- Each circuit must have a B-type circuit breaker of the lowest applicable rating (e.g. B 2A)
- Fixing of cables must comply with IEE regulations (e.g. bending radius, spacing of clips)
- The colours of the wires must be chosen after its intended use and comply with IEE regulations.
- The cross sectional area must be chosen that the voltage drop from the inverter output to the furthest load is not more than 3%.
- Cables exposed to sunshine must be UV resistant, if not they must be installed in UV resistant flexible conduit in a way that no part of the cable is exposed to sunlight at any time.
- Field-installed wiring should be joined using terminal strips or screw connectors. Wire nuts may be used only in indoor locations in appropriate junction boxes or enclosures. All connections must be made in waterproof junction boxes.

- Single wires must be installed in good quality neat ducts or conduits.
- Where structures of the building are drilled, the Contractor must ensure proper workmanship.
- Where extra buildings are to be supplied by power from another building, each outgoing circuit to each building should be terminated at its own breaker in the main Consumer unit.
- Underground cabling - Only armoured underground cable must be used such as the “solidal” cable. The cable should be buried at least 50cm below the surface through a duct that has been pre-buried. Backfilling of soil has to be well done. Neat termination practices should be followed. In special circumstances especially where the distances are very long and the overall costs are too high, then the supply cable can be buried in well laid conduits that are also buried following the method outlined before.
- Insulating materials should comply with heat and fire resistance requirements stipulated by international (IEE) and Ugandan standards (UNBS).
- Load Connections or Outlets: A simple and safe means for connection of user-supplied loads should be provided. Acceptable methods for load connections include insulated terminal strips in waterproof junction boxes. Sockets should be located in rooms where the equipment intended for their use are located.

3.7 The Alarm and Intrusion Detection System

3.7.1 General requirements

The alarm and intrusion detection system shall perform the following functions,

- a) Detect and report any level of mechanical stress on the solar array, inverter and pump house (similar to car-alarm system)
- b) Trigger an audible siren sound, loud enough to be heard by the operator and neighbouring community; when the intruder touches any part of the solar array or metallic mounting frame

3.7.2 Specific technical requirements

System can be powered by AC or DC source. It has programmable control panel which processes the received data and produces an appropriate signal.

3.7.3 System Installation

Control box safely installed in a location that can only be accessed by authorised persons

3.8 Specifications for Metals, Plastics and Concrete Used for Water Tank, Tank Stand and Associated Plumbing Works

3.8.1 Requirements

The contractor shall supply, transport and install the water tanks and all accessories and fixtures required to install the Tank complete and in place, in accordance with the Contract Documents.

3.8.2 References, Codes and Standards

The following standards are referred to in this Part of the Specification.

Reference No.	Subject
BS 497: Part 1	Manholes covers, road gully gratings and frames for drainage purposes: cast iron and steel.
BS 4190	ISO metric black hexagon bolts, screws and nuts.
BS 4211	Steel ladders for permanent access.
BS 4360	Weldable structural steels.
BS 4942: Part 2	Short link chain for lifting purposes: grade M (4) non-calibrated chain.
BS 5135	Process of arc welding of carbon steels.
BS 5834: Part 2	Surface boxes, guards and underground chambers for gas and waterworks purposes: small surface boxes.
BS 6180	Protective barriers in and about buildings.
ISO 216	Drawing sizes
BS 1553	Specification for graphical symbols for general Project Management
BS 1646	Symbolic representation for process measurement control functions and instrumentation
BS 4884	Technical manuals
BS 5070	Project Managing diagram drawing practice
BS 5228	Code of Practice for noise control on construction and demolition sites

Reference Standards Painting and protective coatings

Unless otherwise specified or approved by the Engineer, painting and protective coatings, including surface preparation, shall comply with the relevant Reference Standards listed below:

Standard	Subject
BS 245	Mineral solvents for paints and other purposes.

BS 729	Hot dip galvanised coatings on iron and steel articles.
BS 1224	Electroplated coatings of nickel and chromium.
BS 1336	Knotting.
BS 1387	Screwed and socketed steel tubes
BS 2451	Chilled iron shot and grit.
BS 2569	Sprayed metal coatings.
BS 2989	Continuously hot-dip zinc coated and iron-zinc alloy coated steel strip, sheet and plate.
BS 3416	Bitumen-based coatings for cold application, suitable for use in contact with potable water.
BS 3698	Calcium plumbate priming paints.
BS 4129	Welding primers and weld-through sealants, adhesives and waxes for resistance welding of sheet steel.
BS 4147	Bitumen-based hot-applied coating materials for protecting iron and steel.
BS 4652	Metallic zinc rich priming paint (organic media).
BS 4756	Ready mixed aluminium priming paints for woodwork.
BS 4764	Powder cement paints.
BS 4800	Paint colours for building purposes.
BS 4921	Sherardized coatings on iron and steel.
BS 5252	Colour co-ordination for building purposes.
BS 5358	Solvent-borne priming paints for woodwork.
BS 5493	Code of Practice for protective coating of iron and steel structures against corrosion.
BS 6044	Pavement marking paints.
BS 6150	Code of Practice for painting of buildings.
BS 6900	Raw, refined and boiled linseed oils for paints and varnishes.
BS 6949	Bitumen-based coatings for cold application, excluding use in contact with potable water.
BS 7079	Preparation of steel substrates before application of paints and related products.
CP 3012	Code of Practice for cleaning and preparation of metal surfaces.

Reference Standards Concrete

Unless otherwise specified, materials for concrete, concrete products and testing procedures shall comply with the following Reference Standards where relevant.

Standard	Subject
BS 812	Testing aggregates.
BS 882	Aggregates from natural sources for concrete.
BS 1199/1200	Building sands from natural sources
BS 1881	Testing concrete
BS 3148	Methods of test for water for making concrete
BS 4027	Sulphate-resisting Portland cement.
BS 4550	Methods of testing cement.
BS 5328	Concrete
BS 7263:	Part 1 Precast concrete flags, kerbs, channels, edgings and quadrants.
BS 8007	Concrete for Retaining Aqueous Liquids
BS 8110	Structural use of concrete
CP 102	Protection of buildings against water from the ground
ASTM D 512	Tests for chloride ion in water and waste water.
ASTM D 516	Tests for sulphate ion in water and waste water.

Reference Standards pipelines valves and meters

Unless otherwise specified, pipelines shall comply with the relevant Reference Standards listed below. Where a Reference Standard, or a further standard referred to in a Reference Standard, states that a requirement should be met, it shall be met unless otherwise specified, and where a Reference Standard allows a choice between other standards, preference shall be given to the standard or standards listed as Reference Standards, if any. Where pipelines or any parts thereof are outside the range of sizes covered by the Reference Standards, the requirements of the Reference Standards shall still apply where relevant, unless otherwise specified.

Reference Standards applicable to various types of pipelines include the following standards:

Standard	
BS 2494	Elastomeric seals for joints in pipework and pipelines.
BS 4190	ISO metric black hexagon bolts screws and nuts.
BS 4320	Metal washers for general engineering purposes
BS 4504: Part 3	Circular flanges for pipes, valves and fittings (PN designated): steel, cast iron and copper alloy flanges.
BS 4865	Dimensions of gaskets for pipe flanges to BS 4504.

- BS 5292 Jointing materials and compounds for water, low pressure steam installations, 1st, 2nd and 3rd family gases.
- BS 7079: Parts O and A Preparation of steel substrates before application of paints and related produces: Introduction and visual assessment of surface cleanliness.
- BS 8010: Part 1 Pipelines on land: general
- AWWA C601 Standard for disinfecting water mains
- AWWA M12 Simplified procedures for water examination.

Standards for Steel pipelines

Reference Standards for steel pipelines include the following standards:

Standard:

- BS 534 Steel pipes, joints and specials for water and sewage.
- BS 2569: Part 1 Sprayed metal coatings: protection of iron and steel by aluminium and zinc against atmospheric corrosion.
- BS 4147 Bitumen-based hot-applied coating materials for protecting iron and steel, including suitable primers where required
- BS 4515 Welding of steel pipelines on land and offshore.
- CP 2010: Part 2 Design and construction of steel pipeline on land.
- AWWA M11 Steel pipe design and installation.

Standards for Unplasticized polyvinyl chloride (uPVC) pipes

Reference Standards for uPVC pipes include the following standards:

Standard:

- BS 3505 Unplasticized PVC pipe for cold water services.

3.8.3 Quality Assurance

- A. The CONTRACTOR shall provide a vertical, high density cross-linked polyethylene tank with full drain capability and ability to attach pipe fittings and connections. The flat-bottom, upright, cylindrical tanks moulded in one-piece seamless construction by rotational moulding furnished under this Section shall be supplied by Poly Processing Company or approved equal who has been regularly engaged in the design and manufacture of storage tanks for over 10 years.
- B. Tanks shall be manufactured from virgin materials.
- C. Tanks shall be manufactured from materials certified BS/European standards for chemical /water storage.

3.9 Specifications for Tank Parts, Metal Support and Plumbing Accessories

3.9.1 General

Tanks shall be rotationally-molded, integrally molded flanged outlet, high density cross-linked polyethylene, one-piece seamless construction, cylindrical in cross-section and vertical with flat / sloping bottoms in axis. Tanks shall be adequately vented as prescribed in Poly Processing Company's Technical Bulletin, Venting-Design for ACFM (air cubic feet per minute). Where indicated, tanks shall be provided with ancillary mechanical fittings and accessories. Tanks shall be marked to identify the manufacturer; date of manufacture and serial numbers must be permanently embossed into the tank.

3.9.2 Manufacturer

Tanks shall be manufactured as per the specifications.

3.9.3 Polyethylene Storage Tanks

Service: The Water tanks shall be suited for the following operating conditions per this section.

High Density Cross-linked Polyethylene resin used in the tank manufacture shall be Poly CL™ or equal and shall contain ultraviolet stabilizer as recommended by resin manufacturer. Where black tanks are indicated, the resin shall have a carbon black compounded into it. The tank material shall be rotationally molded and be a resin that is commercially available at the time of tank manufacture.

Wall thickness for a given hoop stress is to be calculated in accordance with ASTM D 1998. Tanks shall be designed using a hoop stress no greater than 600 psi. In NO case shall the tank thickness be less than design requirements per ASTM D 1998.

The Colour of the Water Tank shall be natural (un-pigmented), or black (COMPOUNDED), or as specified by the ENGINEER

3.9.4 Tank Accessories

A. Ladder:

1. [Painted carbon steel], [fiberglass], [galvanized carbon steel] or [stainless steel] access ladders shall be provided with the polyethylene water tanks at locations as shown. Safety cages shall be added to ladders as required,
2. Ladders must be secured to the tank stand/tank and secured to the concrete to allow for tank expansion/ contraction due to temperature and loading changes. Use proper approved chemical & water resistant materials .
3. All ladders shall be designed to meet applicable British/ EU standards.

B. Restraint System:

1. Metal components to be [galvanized], [stainless steel], or [painted clips], edge softeners, and tension ring with [stainless steel], [galvanized] cables and clamps.
2. Tank restraint system shall be supplied and the design of same certified by a

Structural Engineer registered in Uganda. Design shall conform to the most recent edition of the British code for seismic and wind load. Anchor bolts shall be supplied by the tank manufacturer.

3.9.5 Level Indication

Float Indication: The level indicator shall be assembled to the tank and shall consist of PVC float, indicator, polypropylene rope, perforated interior pipe, PVC roller guides, clear UV resistant PVC sight, and necessary pipe supports. The level indicator shall act inversely to the tank contents and shall not allow entrance of tank contents into the sight tube at any time. Indicator shall be neon orange color for visual ease for onsite operators.

3.9.6 Factory Testing

A. Material Testing

1. Perform gel and low temperature impact tests in accordance on condition samples cut from each polyethylene chemical storage tank.

B. Tank Testing

1. Dimensions: Take exterior dimensions with the tank empty, in the vertical position. Outside diameter tolerance, including out-of-roundness. Fitting placement tolerance shall be +/- 1/2-in vertical and +/- 1 degree radial.
2. Visual: Inspect for foreign inclusions, air bubbles, pimples, crazing, cracking
3. Hydrostatic test: Following fabrication, the bottom tanks, including inlet and outlet fittings, shall be hydraulically tested with water by filling to the top sidewall for a minimum of 1 hour and inspected for leaks. Following successful testing, the tank shall be emptied and cleaned prior to shipment.

3.9.7 Supply and Erection Elevated Tanks

General

The levels of the finished tanks must be precisely in accordance with the levels shown on the drawings. All support towers shall be set on concrete foundation slabs which also support all fittings and valves at ground level. Support towers shall be of steel construction as specified below

All tanks shall be fitted with pipes as shown on the drawings. The overflow shall be fitted below the level of the supply valve. The tank drain may be connected to the overflow drain via an appropriate gate valve. All tanks shall be fitted with a drain to allow them to be completely emptied.

Flow into the tank shall be controlled by a float-operated valve. Outlet services shall be taken from the bottom of the tank, and the outlet opening(s) shall be situated higher than the drain opening.

All tanks shall be fitted with float level indicators which shall be easily readable from the ground.

Covers: All tanks shall be equipped with covers to protect the contents. The covers shall be suitable for all loading types including those imposed by men on maintenance and other duties.

Covers shall be adequately ventilated to prevent the buildup of pressure or vacuum inside the tank. Ventilation shall be mosquito proof. Covers shall be of such dimensions as to allow entry into the tanks for servicing and maintenance.

Steel Support Towers

Steel support towers shall be designed for a wind velocity of 45 m/s. They shall be made of commonly available steel profiles conforming with BS 5950. The profiles shall be connected by bolts. For corrosion protection the steel structure shall be galvanized or painted in accordance with BS 5493 SL5 or equivalent, with:

- ◆ Two coats of two- pack epoxy zinc phosphate primer (KP 1A) to total D.F.T. of 140 microns.
- ◆ Two coats of two- pack epoxy undercoat (KU 1B) to total D.F.T. of 200 microns.
- ◆ One coat of chlorinated rubber finishing coat (HF 1D) to 100 microns D.F.T.

Alternatively, the finishing coat could be two-pack polyurethane (KF 2D) to 100 microns D.F.T. in accordance with BS 5493. SK4 painting system or equivalent.

Steel support towers to be designed and supplied by the manufacturer supplying the tank.

Sectional Steel Water Tanks

All sectional steel tanks shall be of rectangular construction using mass-produced tank plates, 1220 mm square and bolted together. All tanks shall conform to BS 1564 or equivalent.

The plates shall be hot pressed embossed steel to BS 4360 grade 43A, or equivalent and shall be between 4 to 6 mm in thickness, determined by the depth of the tank.

Plates shall be formed with 45° or 90° flanges according to their position on the tank. All plates shall be clearly marked to identify them for erection purposes.

Pipe connections shall be flanged.

Tank plates and cover plates shall be hot dipped galvanized to BS 729 or equivalent and then treated with protective coating against corrosion corresponding to BS 5493 SF8 or equivalent after suitable pre-treatment.

Cleats and Stays

All internal fittings shall be designed to ensure the rigidity and strength of each tank. They shall be manufactured from steel to BS 4360 grade 43A or equivalent.

Bolts, Nuts, Washers and Jointing Materials

All bolts, nuts and washers shall comply with BS 4190 or equivalent. Steel tanks shall be supplied with a complete set of spanners and a percentage of spare nuts, bolts and washers.

Jointing strips shall be used between the flanges of adjacent tank plates, under the tank cleats and for seating cover plates. Materials for jointing strips shall be acceptable for use with potable water.

3.9.8 Delivery, Storage, And Handling

- A. The tank shall be shipped upright or lying down on their sides with blocks and slings to keep them from moving. AVOID sharp objects on trailers.
- B. All fittings shall be installed and, if necessary, removed for shipping and shipped separately unless otherwise noted by the contractor.
- C. Upon arrival at the destination, inspect the tank(s) and accessories for damage in transit. If damage has occurred, Poly Processing Company shall be notified immediately.

INSTALLATION

- A. Install the tanks in strict accordance with Poly Processing Company's Tank Installation Manual and shop drawings.
- B. Installation will be inspected by manufacturer to verify system flexible connections, venting and fittings are properly installed. In addition to on-sight inspection tank system(s) to be reviewed using tank manual check list as supplied by manufacture as listed below.
- C. Manufacturer to provide 1 hour training session to prepare operators to service and maintain the tank system. Included in training session will be (#) training manuals.
- D. Manufacturer's trained technician to do an onsite inspection of installation. Inspection will verify chemical application, plumbing connections, venting, and applicable ancillary equipment such as ladders, restraints, etc. A verification of proper installation certificate will be supplied when equipment passes installation checklist.
- E. Tank manuals will consist of installation check lists, tank drawing(s) as built, fitting drawings referencing nozzle schedule on tank drawing, materials of construction, and recommended maintenance program.

FIELD TESTING

All tanks supplied under this contracted shall be hydro-tested for 24 hours prior to commissioning.

3.10 Remote Sensing and Monitoring System

3.10.1 General

The Remote Monitoring System (RMS) is connected to the solar pump controller using Bluetooth or a cable connection. It can therefore read out operational data such as system status motor speed, controller temperature, flow rate, input and output power, input and output voltage and current as well as digital and analog sensor inputs including pressure,

flow rate, water level, well dry, tank full, track sunshine and ambient temperature to correlate water production with current weather conditions.

3.10.2 Remote Control

Communication is not only limited to receiving data, but also controlling the pump system and can be used to switch pump on/ off, switch diesel/ AC back up on/ off, enable/ disable timers and pumping applications such as constant or min/ max flow, pressure and water level.

3.10.3 Remote Monitoring System Components

An effective remote management system is built from carefully integrated components that ensure end to end security, provides resilience and is a good long term investment to deliver operational results. The system consists of sensors, android enabled OS tablets, GPRS /GSM communicator with Sim card, As with all technology, support from the manufacturer is important to ensure that the system works, is continually developed to keep up with new technology, new threats and is maintainable for the future.

3.10.4 Remote Sensing and Monitoring Tools

The ministry will ensure that the following accessories are included on the pumping systems

- i. Well probe for dry run protection
- ii. Digital Flow meters to monitor flow,
- iii. Liquid pressure sensors to monitor pressure,
- iv. Liquid water level sensors to monitor water level in the borehole as pumping takes place,
- v. Sun sensors to measure radiation,
- vi. Controllers with enabled Data loggers to measure current, voltage, temperature, motor speed.
- vii. Communicators with GPRS enabled

3.10.5 Well Probe

The well probe is used for dry run protection of the pump, it contains a mechanical float with a magnet inside. When the Probe is submerged, the float rises, and the magnet actuates a switch. The switch closes (makes contact) to indicate the Presence of water. If the water level drops below the probe, the float drops, and the switch opens (breaks contact): The controller will stop the pump. When the water level recovers and the Switch closes again, the controller will delay the restart for 15 minutes for the water level to recover.

3.10.6 Water Meter

The water meter is used to measure water flow (m³/h); it sends pulses per liter of water that passes through it, it sends the data through the communicator to the web portal. It is calibrated at 100l per pulse.



3.10.7 Level Sensor

The range of liquid level sensors use pressure to measure the level of water in a well or tank. The sensors can be used for long term water level monitoring and also for pump control in applications where a well probe cannot be used. The Level sensor is connected to one of the two Analog Inputs of the controller. Configuration of the sensor is done with Pump Scanner



3.10.8 Pressure Sensor

The range of liquid level sensors use pressure to measure the level of water in a well or tank. The sensors can be used for long term water level monitoring and also for pump control in applications where a well probe cannot be used. The Level sensor is connected to one of the two Analog Inputs of the controller. Configuration of the sensor is done with Pump Scanner



The range of liquid pressure sensors are used to measure the pressure in a pipe. The sensors are commonly used to measure the pressure at a well head.

3.10.9 Sun Sensor

The Sun Sensor is used to stop the pump if the solar power is insufficient. In weak sun conditions the Pump may spin without lifting water all the way to the outlet which causes wear and tear.

3.10.10 Battery

The communicator is powered by a sealed 12V AGM lead acid Battery Min. capacity: 7Ah. The battery is charged by the LC20-12M, PV-Module

3.10.11 LC20- solar module

20w solar PV-Module, Pre-Wired, Fixture For charging the communicator battery

3.10.12 Communication Technology

The remote monitoring technology will use both blue tooth for short range communication and GPRS for long range communication for data transfer from the controllers to the user interfaces as described below;

Short Range access: Bluetooth

Bluetooth is a wireless technology standard for exchanging data over short distances (using short-wavelength UHF radio waves in the ISM band from 2.4 to 2.485 GHz) from fixed and mobile devices, and building personal area networks (PANs).

Bluetooth-enabled phone will be used to communicate with datalogger enabled controller to show the performance parameters

The systems constantly record operational data and store it for real-time or historic analysis. The pump controllers have a Bluetooth™ module which allows for wireless connection using open standard, low costs Android™ devices (phones or tablets). The LORENTZ PS Data Module is an integral data logger and remote control device for the whole PS range of helical, centrifugal and surface pumps.

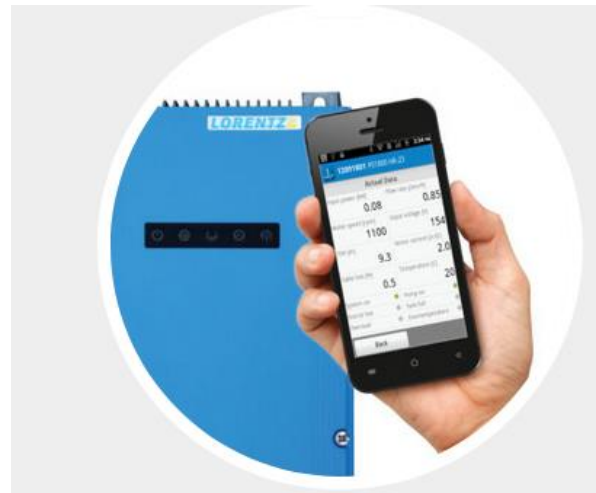

The PS Data Module and Pump Scanner for Andro-id™ App open new opportunities in drinking water supply for people and livestock, irrigation and swimming pool applications.

The PS Data- Module collects performance data from the pump system and stores it for periodic collection. The PS Data Module uses Bluetooth™ to communicate with the LORENTZ Pump Scanner Android™ App allowing secure real time data to be viewed and historic data to be collected without physical connections. The PS Data Module can be specified on any PS pump systems and is embedded in the pump controller. The Pump Scanner App service version is free to use and is available on the respective app stores for universal access

Detailed data and programming is available via Pump Scanner Android™ App. Pump Scanner allows you to see real time and historic data from the system

3.10.13 GSM-Based Far Distance Remote Access

General Packet Radio Services

General Packet Radio Services (GPRS) is a packet-based wireless communication service that promises data rates from 56 up to 114 Kbps and continuous connection to the Internet for mobile phone and computer users. The higher data rates allow users to take part in video conferences and interact with multimedia Web sites and similar applications using mobile handheld devices as well as notebook computers. GPRS is based on Global System for Mobile (GSM) communication and complements existing services such as circuit-switched cellular phone connections and the Short Message Service (SMS). The remote monitoring system will use GPRS to send data to a web portal code named pump manager.

The Solar Water Pumping Systems will be CONNECTED, this means they are easy to configure, provide rich information to users and can be managed remotely from anywhere, the systems will be using widely available global communication system GPRS/GSM. The "CONNECTED" features make configuration simple, reduce site visit costs and ensure you are informed of exactly what your critical solar water pumping system is doing.



Figure 1 - Remote Monitoring of Systems on Pump Manager

Data will be managed from a server located in the Ministry of Water and Environment Premises, but also available on a cloud server. Lorentz will set up a connection between the cloud server and the local server. The cloud server will also be used as a backup of the local server. Data will be regularly updated to create an accurate picture of system performance.

Sample Screen Shoots of The Monitored Parameters

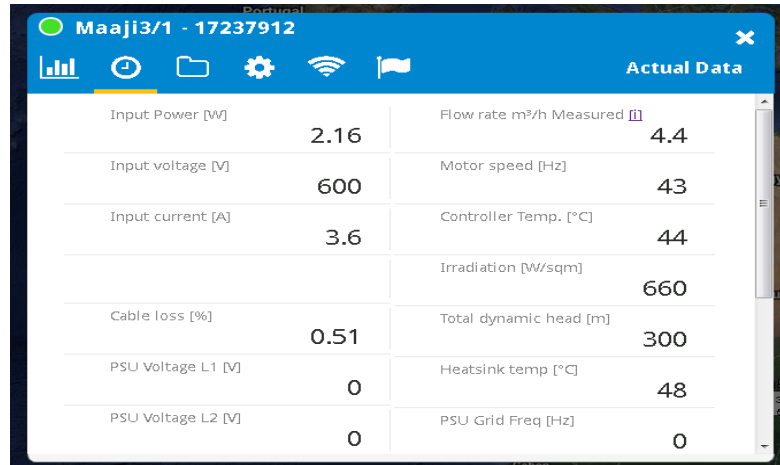

Figure 2 - Screen shot showing p (kw), voltage(v), current (Amps) flow rate (m³/h) motor speed (hz) and temperate

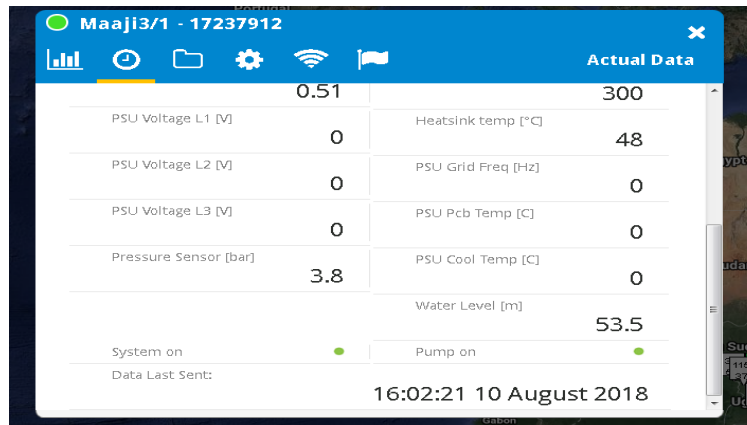

Figure 3 - Screen shot showing pressure (bars), and water level in borehole (m)

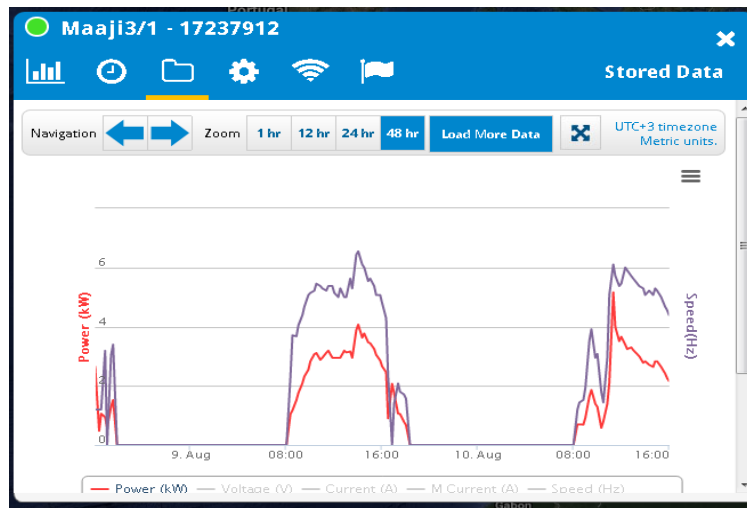

Figure 4 - Screen shot showing variation of power and flow

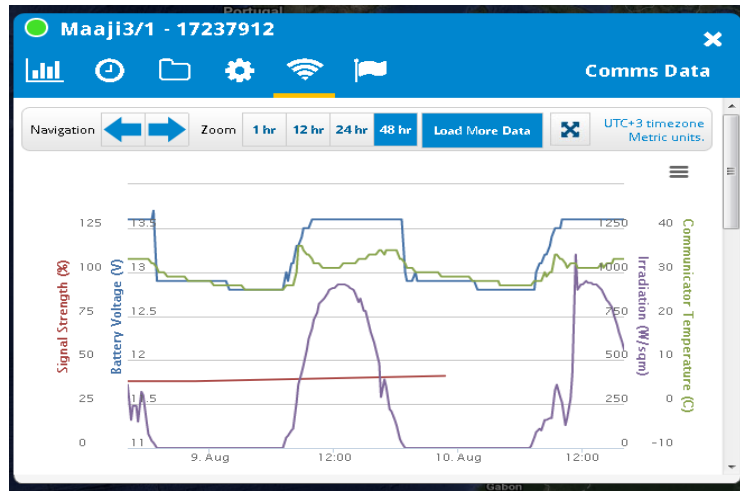

Figure 5 - screen shot showing variation of irradiation, battery voltage, and temperature and signal strength

Section IV: Specifications of Energy Packages for Water Schemes

ABBREVIATIONS AND ACRONYMS

A	Ampere
AC	Alternating current
DC	Direct current
ERT	Energy for Rural Electrification
kW	Kilo Watt
kWh	Kilo Watt-hour
m ³ /hr	cubic meters per hour (1000 liters per hour)
m ³ /day	cubic meters per day (1000 liters per day)
O&M	Operation and Maintenance
MPP	maximum power point of solar-PV modules
pH	Level of Acidity or Alkalinity of water
RGC	Rural Growth Center
ST	Small Town
SPV	Solar Photovoltaic
V	Voltage
Vac	(Alternating current) Voltage
Vdc	(Direct current) Voltage
Wp	Watt-peak

4 Energy packages specifications for water supply systems

4.1 Water Pumping Requirements and System Configuration

4.1.1 Water Pumping Requirements

The table below indicates the selected water supply systems to be powered with solar-PV energy packages with associated safe yields and TDH as provided by Ministry of Water and Environment

Table 4-1: Water pumping Requirements for Lot-1 Water supply schemes

s/n	Name of Water Supply System	District	Umbrella	Safe Borehole Yield (m ³ /hr)	Total Pumping Head (m)
1	Kayunga	Kayunga	Central	23	120
2	Bamunanika	Nakaseke	Central	7	230
3	Banda	Mityana	Central	4	100
4	Ssekanyonyi	Mityana	Central	6	120
5	Kikyusa	Luweero	Central	20	250
6	Mayanga	Buikwe	Central	15	150
7	Kiwenda	Wakiso	Central	25	160
8	Kasambira	Kamuli	East	8	130
9	Buyende 2	Buyende	East	5	90
10	Kagulu	Buyende	East	10	165

4.1.2 Solar Irradiance Data

The districts that have got the solar irradiance below include: Kayunga, Nakaseke, Mityana, Luweero, Buikwe, Wakiso, Kamuli and Buyende located in the regions of Eastern, and Central respectively.

Table 4-2: Solar Irradiance Data for Lot-1 Water supply schemes

Month	(kW-hr/m ² /day)												
	Jan	Feb	Mar	Apr	May	Jun	Jul	Aug	Sept	Oct	Nov	Dec	Avg
Solar Irradiance for Equator Facing Horizontal Surface	6.15	6.18	5.83	5.68	5.68	5.17	4.91	5.21	5.75	5.73	5.72	5.93	5.66
Month	(Days)												
	Jan	Feb	Mar	Apr	May	Jun	Jul	Aug	Sept	Oct	Nov	Dec	Avg
Equivalent No-Sun Days Over A Month Period	1.96	5.00	2.77	1.75	1.62	3.34	4.24	2.56	2.00	3.04	2.02	3.85	2.85
<i>Source: https://power.larc.nasa.gov/data-access-viewer/</i>													

4.1.3 Energy Package Design Packages

Table 4-3: Summary of Energy package demand for EASP Water Systems Solar Energy Packages

s/n	Water Scheme	District	Pumping Head Requirements	Pump Size (kW)	Inverter Size (kW)	Solar Array Size (kWp)	Total estimated Water yield of package
1	Bamunanika	Nakaseke	Yield=7.0m ³ /hr, TDH=230m	Q _{max} =7.0m ³ /hr, H=230m, 7.5kW, 17.2A, 415V/ 50Hz	11.0kW,415V/ 50Hz, 24Amps	17.7kWp/3x9.29Amps/ 630Vmp, 3x20pcs rated 295Wp/ 31.7V/ 9.29amp	Average=47.3m ³ /day, Max=51.6m ³ /day
2	Banda	Mityana	Yield=4.0m ³ /hr, TDH=100m	Q _{max} =4.0m ³ /hr, H=100m, 2.2kW, 5.5A, 415V/ 50Hz	3.7kW,415V/ 50Hz, 9Amps	5.9kWp/1x9.29Amps/ 630Vmp, 1x20pcs rated 295Wp/ 31.7V/ 9.29amp	Average=25.0m ³ /day, Max=27.3m ³ /day
3	Buyende-2	Buyende	Yield=5.0m ³ /hr, TDH=90m	Q _{max} =5.0m ³ /hr, H=90m, 2.2kW, 5.5A, 415V/ 50Hz	3.7kW,415V/ 50Hz, 9Amps	5.9kWp/1x9.29Amps/ 630Vmp, 1x20pcs rated 295Wp/ 31.7V/ 9.29amp	Average=33.7m ³ /day, Max=36.8m ³ /day
4	Kagulu	Buyende	Yield=10.0m ³ /hr, TDH=165m	Q _{max} =9.59m ³ /hr, H=165m, 7.5kW, 17.2A, 415V/ 50Hz	11.0kW,415V/ 50Hz, 24Amps	17.7kWp/3x9.29Amps/ 630Vmp, 3x20pcs rated 295Wp/ 31.7V/ 9.29amp	Average=65.5m ³ /day, Max=71.5m ³ /day
5	Kasambira	Kamuli	Yield=8.0m ³ /hr, TDH=130m	Q _{max} =8.0m ³ /hr, H=130m, 5.5kW, 13.0A, 415V/ 50Hz	7.5kW,415V/ 50Hz, 18Amps	11.8kWp/2x9.29Amps/ 630Vmp, 2x20pcs rated 295Wp/ 31.7V/ 9.29amp	Average=56.1m ³ /day, Max=61.2m ³ /day
6	Kayunga	Kayunga	Yield=23.0m ³ /hr, TDH=120m	Q _{max} =23m ³ /hr, H=120m, 13kW, 29.0A, 415V/ 50Hz	18.0kW,415V/ 50Hz, 39Amps	23.6kWp/4x9.29Amps/ 630Vmp, 4x20pcs rated 295Wp/ 31.7V/ 9.29amp	Average=142.5m ³ /day, Max=155.5m ³ /day

7	Kikyusa	Luweero	Yield=20.0m ³ /hr, TDH=250m	Q _{max} =20.0m ³ /hr, H=250m, 26kW, 55.5A, 415V/ 50Hz	30.0kW,415V/ 50Hz, 65Amps	41.3kWp/7x9.29Amps/ 630Vmp, 7x20pcs rated 295Wp/ 31.7V/ 9.29amp	Average=114m ³ /day, Max=124.4m ³ /day
8	Kiwenda	Wakiso	Yield=25.0m ³ /hr, TDH=160m	Q _{max} =25.0m ³ /hr, H=160m, 18.5kW, 41.0A, 415V/ 50Hz	22.0kW,415V/ 50Hz, 48Amps	26.55kWp/5x9.29Amps/ 630Vmp, 5x20pcs rated 295Wp/ 31.7V/ 9.29amp	Average=136.9m ³ /day, Max=149.5m ³ /day
9	Mayanga	Buikwe	Yield=15.0m ³ /hr, TDH=150m	Q _{max} =15.0m ³ /hr, H=150m, 11kW, 25.0A, 415V/ 50Hz	15.0kW,415V/ 50Hz, 30Amps	23.6kWp/4x9.29Amps/ 630Vmp, 4x20pcs rated 295Wp/ 31.7V/ 9.29amp	Average=107.9m ³ /day, Max=117.8m ³ /day
10	Ssekanyonyi	Mityana	Yield=6.0m ³ /hr, TDH=120m	Q _{max} =6.0m ³ /hr, H=120m, 4.0kW, 9.6A, 415V/ 50Hz	7.5kW,415V/ 50Hz, 18Amps	11.8kWp/2x9.29Amps/ 630Vmp, 2x20pcs rated 295Wp/ 31.7V/ 9.29amp	Average=57.3m ³ /day, Max=62.5m ³ /day

4.2 Bamunanika Water Supply System

4.2.1 Energy System Specifications for Bamunanika Water Supply System

Array power output: the minimum power to be supplied by the array to power the water pump shall be at least 7.5kW at a solar isolation of 5.7kWh/m²/day for a solar-PV Energy package of 17.7kWp and shall meet the following technical particulars;

Parameter	Characteristics
Solar module rating	295Wp/ 31.7V/ 9.29amp
System voltage configuration	V_{mpp} : 630V _{DC}
The solar-PV array power rating	17.7kWp
# of solar modules to supply required power	3x20pieces (1 string consists 20 modules)
Solar module material	Mono/ Poly crystalline Silicon
Solar module warranty	25years
Solar module certification	UL, ISO, IEC and IEE requirements

Inverter specification: the inverter to be supplied and installed will be a three phase DC-AC variable speed drive for direct interconnection with the solar array with MPPT power control algorithm.

Parameter	Characteristics
DC Input voltage	V_{mpp} : 500-700V _{DC} V_{max} : 850V _{VOC}
AC Input voltage	3PH 415V _{ac} ; 50Hz
Rated Power output	11.0kW at 98% efficiency at full load, 0.95pf; 50Hz (Variable speed, +5hz selectable speed increase)
Output voltage	24A, 3PH 380-440V 50Hz
Power control	Based on IGBTs for digital signal processing, with Pulse-width modulation
Power control algorithm	Maximum Power Point Tracking
Protection Grade	IP65
Other features	Compatible with submersible pumps, surface pumps, using induction motors; 8 years' storage capacity for operation data. Support soft start of pump. Full motor protections; water level switch to protect overflow and dry running; Support PV/AC power complementary input, with solar priority function selection which can meet the requirement of 24 hours application while the priority is given to the maximum utility of solar energy and the AC power supply is automatically shielded to achieved the goal of main power saving; Support

	multi-pump linkage operation function, meet the expansion of large-flow and high-lift systems application
Warranty	10years
Certification	UL, ISO, IEC and IEE requirements

Water pump specification: The water pump to be used at Banda Water scheme shall be centrifugal multistage submersible pump with a 3-phase AC-type, corrosion-resistant motor, all stainless steel exterior construction, stainless steel splined shaft, NEMA mounting dimensions, hermetically-sealed windings, water lubrication and with a pressure equalizing diaphragm

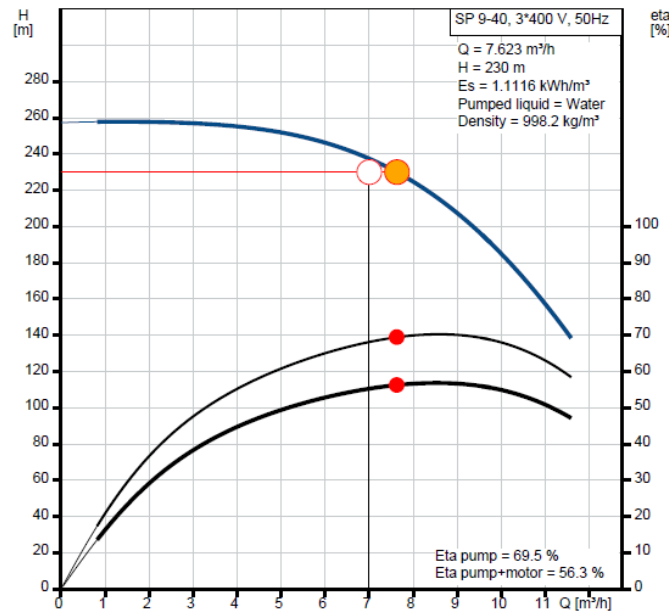

Figure 4-1; Variable speed performance curve of the pump selected for Bamunanika Water System

The pump end shall be constructed from centrifugal multistage direct-coupled pump end, with non-return valve, of material: stainless steel (AISI 304), rubber, dry running protection, shall withstand maximum sand content of 50 g/m³, maximum salt content of 300-500 ppm at maximum 30°C, with water pH value of 6-9 and shall be of high life expectancy

Table 4-4: Water pump specifications for Bamunanika Water System

Parameter	Characteristics
Pump type	Submersible, Multistage Centrifugal pump
Pumping Requirements (Q-H)	7.0m ³ /hr at 230m head
Pumping Duration	10 hours [Max. 5.7 sun peak hours using solar energy]
Rated Power of Pump	7.5kW at Full-load conditions, 69.5% eta-pump
Specific Energy consumption	4.83Wh/m ³ /m and 1.1115kWh/m ³
Motor type	Variable speed/frequency controlled
Phases	3 phase

Voltage	380-400-415 V
Frequency:	50 Hz [Variable speed +3Hz]
Current (rated)	17.2 A
Power factor (actual)	0.76 at rated current
Water max temp	40°C

4.2.2 Design summary for Bamunanika Energy Package

The table below shows the design summary of the solar-PV energy package that matches the specified inverter and pump to abstract as much water as possible within the limits of the available borehole well

Item	Particulars
Pump Size	Qmax=7.0m ³ /hr, H=230m, 7.5kW, 17.2A, 415V/ 50Hz
Inverter Size	11.0kW,415V/ 50Hz, 24Amps
Solar Array Size	17.7kWp/3x9.29Amps/ 630Vmp, 3x20pcs rated 295Wp/ 31.7V/ 9.29amp
Energy generated	84.0kWh/day
Total estimated Water yield of package	Average=47.3m ³ /day, Max=51.6m ³ /day

The figure below shows the daily performance of the energy package

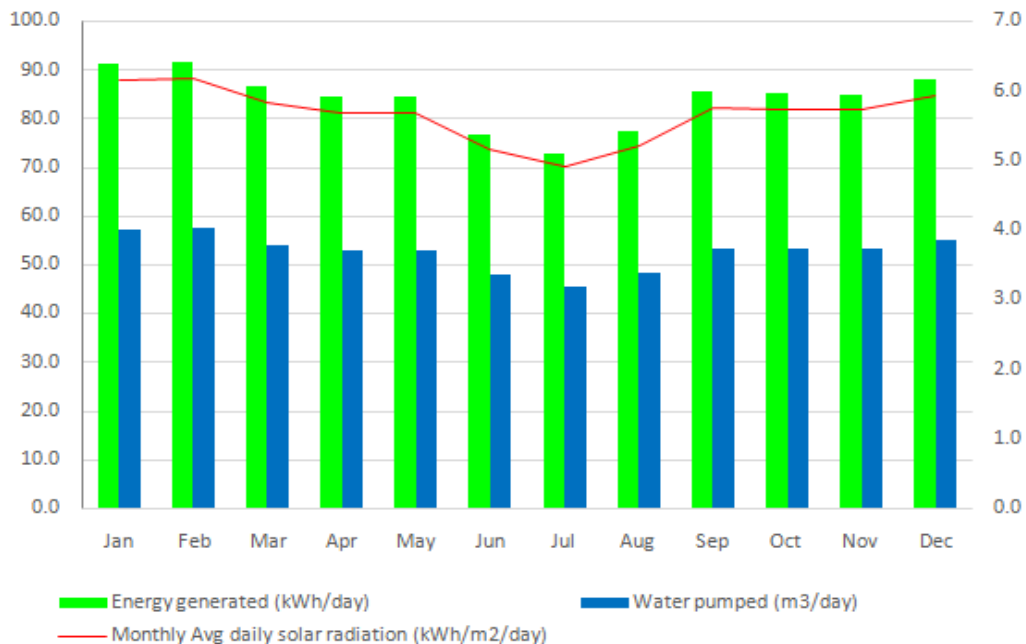

Figure 4-2; Daily Water pumping performance of the Bamunanika energy package

4.3 Banda Water Supply System

4.3.1 Energy System Specifications for Banda Water Supply System

Array power output: the minimum power to be supplied by the array to power the water pump shall be atleast 2.2kW at a solar isolation of 5.7kWh/m²/day for a solar-PV Energy package of 5.9kWp and shall meet the following technical particulars

Parameter	Characteristics
Solar module rating	295Wp/ 31.7V/ 9.29amp
System voltage configuration	V_{mpp} : 630V _{DC}
The solar-PV array power rating	5.9kWp
# of solar modules to supply required power	1x20pieces (1 string consists 20 modules)
Solar module material	Mono/ Poly crystalline Silicon
Solar module warranty	25years
Solar module certification	UL, ISO, IEC and IEE requirements

Inverter specification: the inverter to be supplied and installed will be a three phase DC-AC variable speed drive for direct interconnection with the solar array with MPPT power control algorithm.

Parameter	Characteristics
DC Input voltage	V_{mpp} : 500-700V _{DC} V_{max} : 850V _{VOC}
AC Input voltage	3PH 415V _{ac} ; 50Hz
Rated Power output	3.7kW at 98% efficiency at full load, 0.95pf; 50Hz (Variable speed, +5hz selectable speed increase)
Output voltage	9A, 3PH 380-440V 50Hz
Power control	Based on IGBTs for digital signal processing, with Pulse-width modulation
Power control algorithm	Maximum Power Point Tracking
Protection Grade	IP65
Other features	Compatible with submersible pumps, surface pumps, using induction motors; 8 years' storage capacity for operation data. Support soft start of pump. Full motor protections; water level switch to protect overflow and dry running; Support PV/AC power complementary input, with solar priority function selection which can meet the requirement of 24 hours application while the priority is given to the maximum utility of solar energy and the AC power supply is automatically shielded to achieved the goal of main power saving; Support

	multi-pump linkage operation function, meet the expansion of large-flow and high-lift systems application
Warranty	10years
Certification	UL, ISO, IEC and IEE requirements

Water pump specification: The water pump to be used at Banda Water scheme shall be centrifugal multistage submersible pump with a 3-phase AC-type, corrosion-resistant motor, all stainless steel exterior construction, stainless steel splined shaft, NEMA mounting dimensions, hermetically-sealed windings, water lubrication and with a pressure equalizing diaphragm

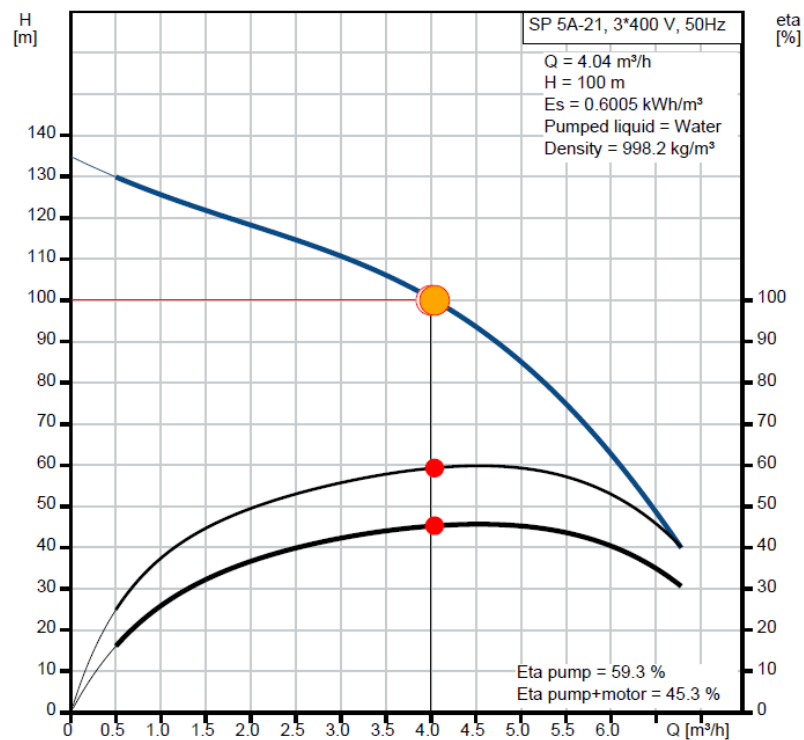

Figure 4-3; Variable speed performance curve of the pump selected for Banda Water System

The pump end shall be constructed from centrifugal multistage direct-coupled pump end, with non-return valve, of material: stainless steel (AISI 304), rubber, dry running protection, shall withstand maximum sand content of 50 g/m³, maximum salt content of 300-500 ppm at maximum 30°C, with water pH value of 6-9 and shall be of high life expectancy

Table 4-5: Water pump specifications for Banda Water System

Parameter	Characteristics
Pump type	Submersible, Multistage Centrifugal pump
Pumping Requirements (Q-H)	4.0m ³ /hr at 100m head
Pumping Duration	10 hours [Max. 5.7 sun peak hours using solar energy]
Rated Power of Pump	2.2kW at Full-load conditions, 59.3% eta-pump

Specific Energy consumption	5.98Wh/m ³ /m and 0.5976kWh/m ³
Motor type	Variable speed/frequency controlled
Phases	3 phase
Voltage	380-400-415 V
Frequency:	50 Hz [Variable speed +3Hz]
Current (rated)	5.5 A
Power factor (actual)	0.76 at rated current
Water max temp	40°C

4.3.2 Design summary for Banda Energy Package

The table below shows the design summary of the solar-PV energy package that matches the specified inverter and pump to abstract as much water as possible within the limits of the available borehole well

Item	Particulars
Pump Size	Qmax=4.0m ³ /hr, H=100m, 2.2kW, 5.5A, 415V/ 50Hz
Inverter Size	3.7kW,415V/ 50Hz, 9Amps
Solar Array Size	5.9kWp/1x9.29Amps/ 630Vmp, 1x20pcs rated 295Wp/ 31.7V/ 9.29amp
Energy generated	23.8 kWh/day
Total estimated Water yield of package	Average=25.0m ³ /day, Max=27.3m ³ /day

The figure below shows the daily performance of the energy package

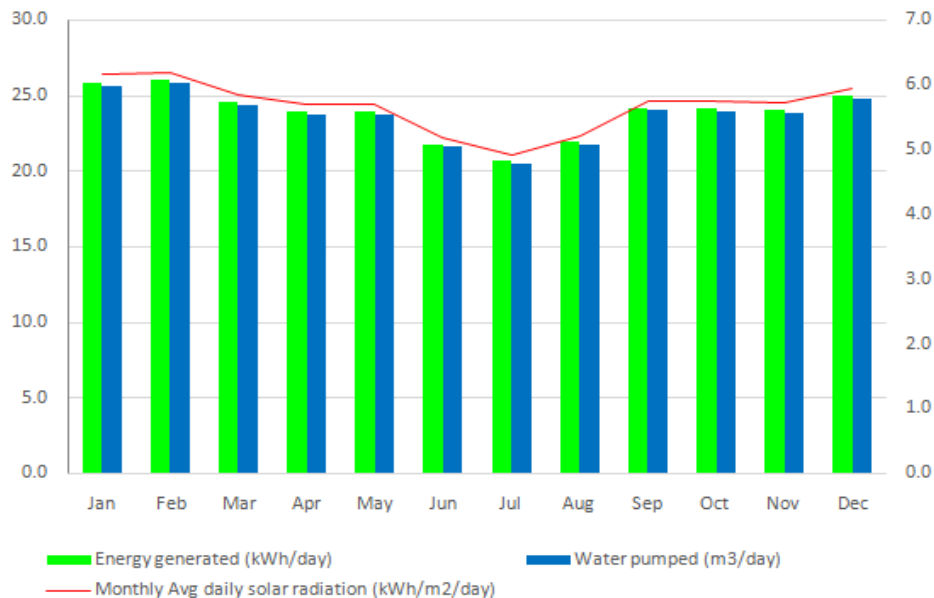

Figure 4-4; Daily Water pumping performance of the Banda energy package

4.4 Kayunga Water Supply System

4.4.1 Energy System Specifications for Kayunga Water Supply System

Array power output: the minimum power to be supplied by the array to power the water pump shall be atleast 13.0kW at a solar isolation of 5.7kWh/m²/day for a solar-PV Energy package of 23.6kWp and shall meet the following technical particulars

Parameter	Characteristics
Solar module rating	295Wp/ 31.7V/ 9.29amp
System voltage configuration	V_{mpp} : 630V _{DC}
The solar-PV array power rating	23.6kWp
# of solar modules to supply required power	4x20pieces (1 string consists 20 modules)
Solar module material	Mono/ Poly crystalline Silicon
Solar module warranty	25years
Solar module certification	UL, ISO, IEC and IEE requirements

Inverter specification: the inverter to be supplied and installed will be a three phase DC-AC variable speed drive for direct interconnection with the solar array with MPPT power control algorithm.

Parameter	Characteristics
DC Input voltage	V_{mpp} : 500-700V _{DC} V_{max} : 850V _{VOC}
AC Input voltage	3PH 415V _{ac} ; 50Hz
Rated Power output	18.0kW at 98% efficiency at full load, 0.95pf; 50Hz (Variable speed, +5hz selectable speed increase)
Output voltage	39A, 3PH 380-440V 50Hz
Power control	Based on IGBTs for digital signal processing, with Pulse-width modulation
Power control algorithm	Maximum Power Point Tracking
Protection Grade	IP65
Other features	Compatible with submersible pumps, surface pumps, using induction motors; 8 years' storage capacity for operation data. Support soft start of pump. Full motor protections; water level switch to protect overflow and dry running; Support PV/AC power complementary input, with solar priority function selection which can meet the requirement of 24 hours application while the priority is given to the maximum utility of solar energy and the AC power supply is automatically shielded to achieved the goal of main power saving; Support

	multi-pump linkage operation function, meet the expansion of large-flow and high-lift systems application
Warranty	10years
Certification	UL, ISO, IEC and IEE requirements

Water pump specification: The water pump to be used at Kayunga Water scheme shall be centrifugal multistage submersible pump with a 3-phase AC-type, corrosion-resistant motor, all stainless steel exterior construction, stainless steel splined shaft, NEMA mounting dimensions, hermetically-sealed windings, water lubrication and with a pressure equalizing diaphragm

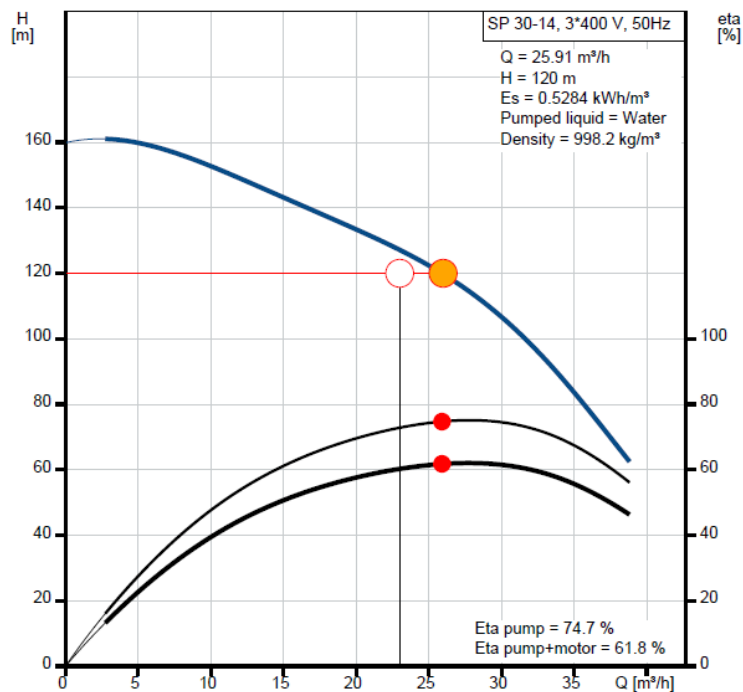

Figure 4-5; Variable speed performance curve of the pump selected for Kayunga Water System

The pump end shall be constructed from centrifugal multistage direct-coupled pump end, with non-return valve, of material: stainless steel (AISI 304), rubber, dry running protection, shall withstand maximum sand content of 50 g/m³, maximum salt content of 300-500 ppm at maximum 30°C, with water pH value of 6-9 and shall be of high life expectancy

Table 4-6: Water pump specifications for Kayunga Water System

Parameter	Characteristics
Pump type	Submersible, Multistage Centrifugal pump
Pumping Requirements (Q-H)	23.0m ³ /hr at 120m head
Pumping Duration	10 hours [Max. 5.7 sun peak hours using solar energy]
Rated Power of Pump	13.0kW at Full-load conditions, 74.7% eta-pump
Specific Energy consumption	4.4Wh/m ³ /m and 0.5283kWh/m ³

Motor type	Variable speed/frequency controlled
Phases	3 phase
Voltage	380-400-415 V
Frequency:	50 Hz [Variable speed +3Hz]
Current (rated)	29.0A
Power factor (actual)	0.80 at rated current
Water max temp	40°C

4.4.2 Design summary for Kayunga Energy Package

The table below shows the design summary of the solar-PV energy package that matches the specified inverter and pump to abstract as much water as possible within the limits of the available borehole well

Item	Particulars
Pump Size	Qmax=23.0m ³ /hr, H=120m, 13kW, 29.0A, 415V/ 50Hz
Inverter Size	18.0kW,415V/ 50Hz, 39Amps
Solar Array Size	23.6kWp/4x9.29Amps/ 630Vmp, 4x20pcs rated 295Wp/ 31.7V/ 9.29amp
Energy generated	112.0kWh/day
Total estimated Water yield of package	Average=142.5m ³ /day, Max=155.5m ³ /day

The figure below shows the daily performance of the energy package

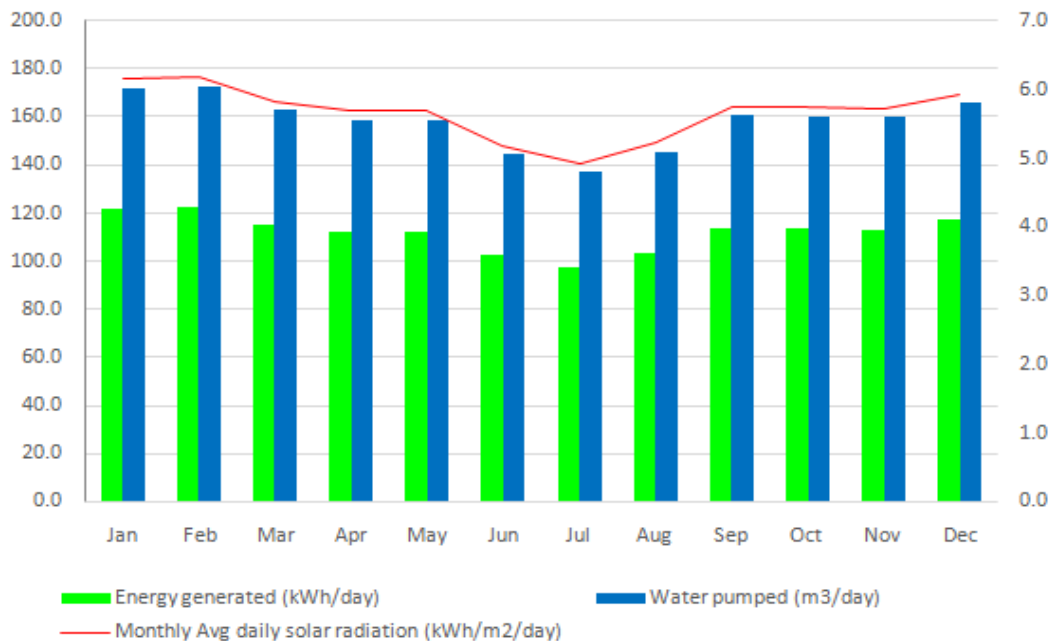

Figure 4-6; Daily Water pumping performance of the Kayunga energy package

4.5 Kikyusa Water Supply System

4.5.1 Energy System Specifications for Kikyusa Water Supply System

Array power output: the minimum power to be supplied by the array to power the water pump shall be atleast 26.0kW at a solar isolation of 5.7kWh/m²/day for a solar-PV Energy package of 41.3kWp and shall meet the following technical particulars

Parameter	Characteristics
Solar module rating	295Wp/ 31.7V/ 9.29amp
System voltage configuration	V_{mpp} : 630V _{DC}
The solar-PV array power rating	41.3kWp
# of solar modules to supply required power	7x20pieces (1 string consists 20 modules)
Solar module material	Mono/ Poly crystalline Silicon
Solar module warranty	25years
Solar module certification	UL, ISO, IEC and IEE requirements

Inverter specification: the inverter to be supplied and installed will be a three phase DC-AC variable speed drive for direct interconnection with the solar array with MPPT power control algorithm.

Parameter	Characteristics
DC Input voltage	V_{mpp} : 500-700V _{DC} V_{max} : 850V _{VOC}
AC Input voltage	3PH 415V _{ac} ; 50Hz
Rated Power output	30.0kW at 98% efficiency at full load, 0.95pf; 50Hz (Variable speed, +5hz selectable speed increase)
Output voltage	65A, 3PH 380-440V 50Hz
Power control	Based on IGBTs for digital signal processing, with Pulse-width modulation
Power control algorithm	Maximum Power Point Tracking
Protection Grade	IP65
Other features	Compatible with submersible pumps, surface pumps, using induction motors; 8 years' storage capacity for operation data. Support soft start of pump. Full motor protections; water level switch to protect overflow and dry running; Support PV/AC power complementary input, with solar priority function selection which can meet the requirement of 24 hours application while the priority is given to the maximum utility of solar energy and the AC power supply is automatically shielded to achieved the goal of main power saving; Support

	multi-pump linkage operation function, meet the expansion of large-flow and high-lift systems application
Warranty	10years
Certification	UL, ISO, IEC and IEE requirements

Water pump specification: The water pump to be used at Kikyusa Water scheme shall be centrifugal multistage submersible pump with a 3-phase AC-type, corrosion-resistant motor, all stainless steel exterior construction, stainless steel splined shaft, NEMA mounting dimensions, hermetically-sealed windings, water lubrication and with a pressure equalizing diaphragm

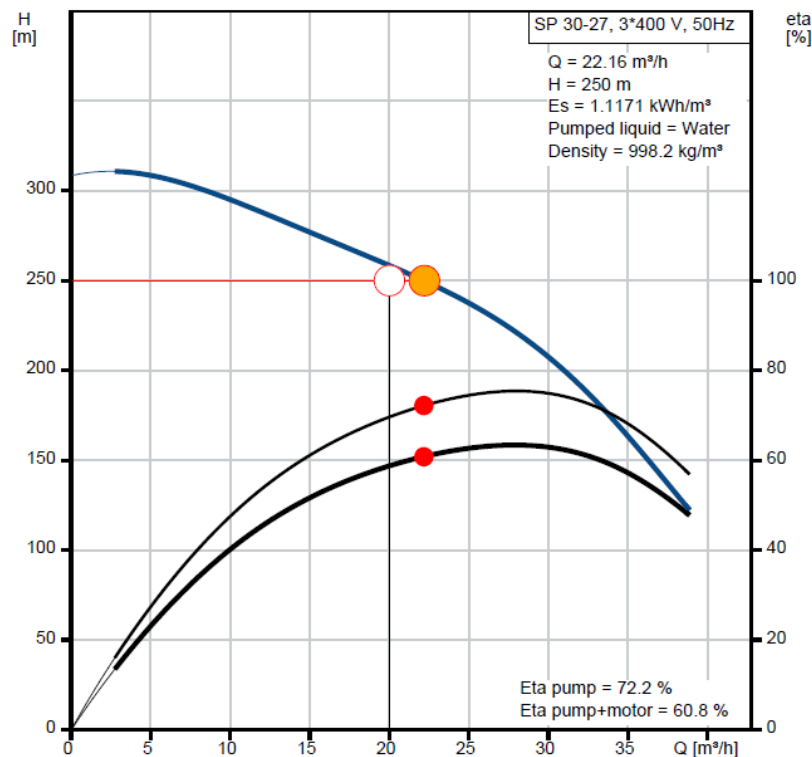

Figure 4-7; Variable speed performance curve of the pump selected for Kikyusa Water System

The pump end shall be constructed from centrifugal multistage direct-coupled pump end, with non-return valve, of material: stainless steel (AISI 304), rubber, dry running protection, shall withstand maximum sand content of 50 g/m³, maximum salt content of 300-500 ppm at maximum 30°C, with water pH value of 6-9 and shall be of high life expectancy

Table 4-7: Water pump specifications for Kikyusa Water System

Parameter	Characteristics
Pump type	Submersible, Multistage Centrifugal pump
Pumping Requirements (Q-H)	20.0m ³ /hr at 250m head
Pumping Duration	10 hours [Max. 5.7 sun peak hours using solar energy]
Rated Power of Pump	26.0kW at Full-load conditions, 72.2% eta-pump

Specific Energy consumption	4.47Wh/m ³ /m and 1.1173kWh/m ³
Motor type	Variable speed/frequency controlled
Phases	3 phase
Voltage	380-400-415 V
Frequency:	50 Hz [Variable speed +3Hz]
Current (rated)	55.5A
Power factor (actual)	0.82 at rated current
Water max temp	40°C

4.5.2 Design summary for Kikyusa Energy Package

The table below shows the design summary of the solar-PV energy package that matches the specified inverter and pump to abstract as much water as possible within the limits of the available borehole well

Item	Particulars
Pump Size	Qmax=20.0m ³ /hr, H=250m, 26kW, 55.5A, 415V/ 50Hz
Inverter Size	30.0kW, 415V/ 50Hz, 65Amps
Solar Array Size	41.3kWp/7x9.29Amps/ 630Vmp, 7x20pcs rated 295Wp/ 31.7V/ 9.29amp
Energy generated	176.3kWh/day
Total estimated Water yield of package	Average=114m ³ /day, Max=124.4m ³ /day

The figure below shows the daily performance of the energy package

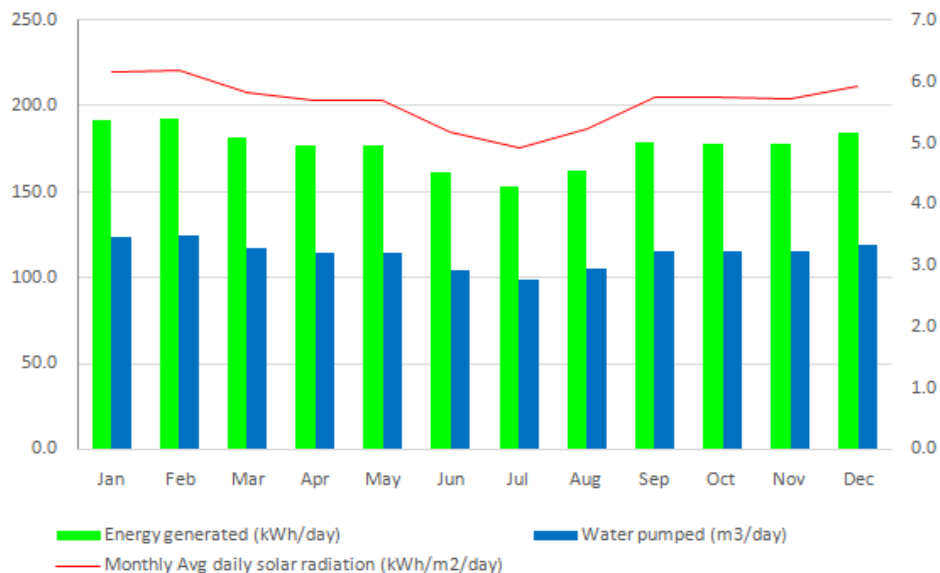

Figure 4-8; Daily Water pumping performance of the Kikyusa energy package

4.6 Kiwenda Water Supply System

4.6.1 Energy System Specifications for Kiwenda Water Supply System

Array power output: the minimum power to be supplied by the array to power the water pump shall be atleast 18.5kW at a solar isolation of 5.7kWh/m²/day for a solar-PV Energy package of 26.55kWp and shall meet the following technical particulars

Parameter	Characteristics
Solar module rating	295Wp/ 31.7V/ 9.29amp
System voltage configuration	V_{mpp} : 630V _{DC}
The solar-PV array power rating	26.55kWp
# of solar modules to supply required power	5x20pieces (1 string consists 20 modules)
Solar module material	Mono/ Poly crystalline Silicon
Solar module warranty	25years
Solar module certification	UL, ISO, IEC and IEE requirements

Inverter specification: the inverter to be supplied and installed will be a three phase DC-AC variable speed drive for direct interconnection with the solar array with MPPT power control algorithm.

Parameter	Characteristics
DC Input voltage	V_{mpp} : 500-700V _{DC} V_{max} : 850V _{VOC}
AC Input voltage	3PH 415V _{ac} ; 50Hz
Rated Power output	22.0kW at 98% efficiency at full load, 0.95pf; 50Hz (Variable speed, +5hz selectable speed increase)
Output voltage	48A, 3PH 380-440V 50Hz
Power control	Based on IGBTs for digital signal processing, with Pulse-width modulation
Power control algorithm	Maximum Power Point Tracking
Protection Grade	IP65
Other features	Compatible with submersible pumps, surface pumps, using induction motors; 8 years' storage capacity for operation data. Support soft start of pump. Full motor protections; water level switch to protect overflow and dry running; Support PV/AC power complementary input, with solar priority function selection which can meet the requirement of 24 hours application while the priority is given to the maximum utility of solar energy and the AC power supply is automatically shielded to achieved the goal of main power saving; Support

	multi-pump linkage operation function, meet the expansion of large-flow and high-lift systems application
Warranty	10years
Certification	UL, ISO, IEC and IEE requirements

Water pump specification: The water pump to be used at Kiwenda Water scheme shall be centrifugal multistage submersible pump with a 3-phase AC-type, corrosion-resistant motor, all stainless steel exterior construction, stainless steel splined shaft, NEMA mounting dimensions, hermetically-sealed windings, water lubrication and with a pressure equalizing diaphragm

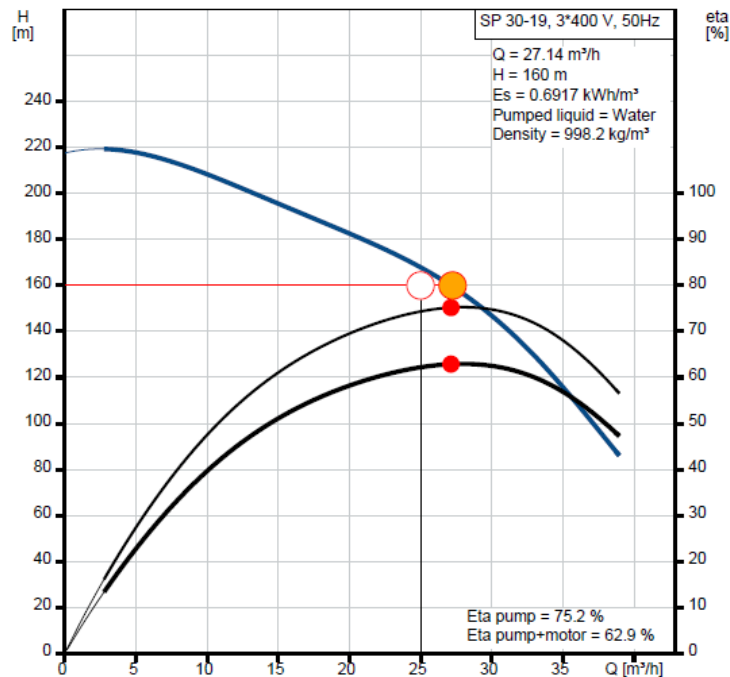

Figure 4-9; Variable speed performance curve of the pump selected for Kiwenda Water System

The pump end shall be constructed from centrifugal multistage direct-coupled pump end, with non-return valve, of material: stainless steel (AISI 304), rubber, dry running protection, shall withstand maximum sand content of 50 g/m³, maximum salt content of 300-500 ppm at maximum 30°C, with water pH value of 6-9 and shall be of high life expectancy

Table 4-8: Water pump specifications for Kiwenda Water System

Parameter	Characteristics
Pump type	Submersible, Multistage Centrifugal pump
Pumping Requirements (Q-H)	25.0m ³ /hr at 160m head
Pumping Duration	10 hours [Max. 5.7 sun peak hours using solar energy]
Rated Power of Pump	18.5kW at Full-load conditions, 75.2% eta-pump
Specific Energy consumption	4.32Wh/m ³ /m and 0.6917kWh/m ³
Motor type	Variable speed/frequency controlled

Phases	3 phase
Voltage	380-400-415 V
Frequency:	50 Hz [Variable speed +3Hz]
Current (rated)	41.0A
Power factor (actual)	0.79 at rated current
Water max temp	40°C

4.6.2 Design summary for Kiwenda Energy Package

The table below shows the design summary of the solar-PV energy package that matches the specified inverter and pump to abstract as much water as possible within the limits of the available borehole well

Item	Particulars
Pump Size	Qmax=25.0m ³ /hr, H=160m, 18.5kW, 41.0A, 415V/ 50Hz
Inverter Size	22.0kW,415V/ 50Hz, 48Amps
Solar Array Size	26.55kWp/5x9.29Amps/ 630Vmp, 5x20pcs rated 295Wp/ 31.7V/ 9.29amp
Energy generated	126.0kWh/day
Total estimated Water yield of package	Average=136.9m ³ /day, Max=149.5m ³ /day

The figure below shows the daily performance of the energy package

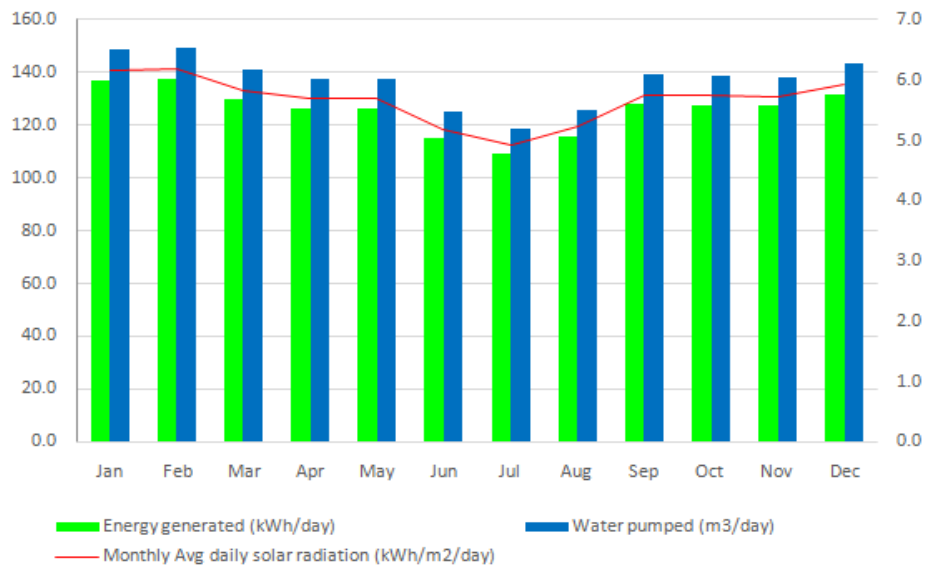

Figure 4-10; Daily Water pumping performance of the Kiwenda energy package

4.7 Mayanga Water Supply System

4.7.1 Energy System Specifications for Mayanga Water Supply System

Array power output: the minimum power to be supplied by the array to power the water pump shall be atleast 11.0kW at a solar isolation of 5.7kWh/m²/day for a solar-PV Energy package of 23.6kWp and shall meet the following technical particulars

Parameter	Characteristics
Solar module rating	295Wp/ 31.7V/ 9.29amp
System voltage configuration	V_{mpp} : 630V _{DC}
The solar-PV array power rating	23.6kWp
# of solar modules to supply required power	4x20pieces (1 string consists 20 modules)
Solar module material	Mono/ Poly crystalline Silicon
Solar module warranty	25years
Solar module certification	UL, ISO, IEC and IEE requirements

Inverter specification: the inverter to be supplied and installed will be a three phase DC-AC variable speed drive for direct interconnection with the solar array with MPPT power control algorithm.

Parameter	Characteristics
DC Input voltage	V_{mpp} : 500-700V _{DC} V_{max} : 850V _{VOC}
AC Input voltage	3PH 415V _{ac} ; 50Hz
Rated Power output	15.0kW at 98% efficiency at full load, 0.95pf; 50Hz (Variable speed, +5hz selectable speed increase)
Output voltage	30A, 3PH 380-440V 50Hz
Power control	Based on IGBTs for digital signal processing, with Pulse-width modulation
Power control algorithm	Maximum Power Point Tracking
Protection Grade	IP65
Other features	Compatible with submersible pumps, surface pumps, using induction motors; 8 years' storage capacity for operation data. Support soft start of pump. Full motor protections; water level switch to protect overflow and dry running; Support PV/AC power complementary input, with solar priority function selection which can meet the requirement of 24 hours application while the priority is given to the maximum utility of solar energy and the AC power supply is automatically shielded to achieved the goal of main power saving; Support

	multi-pump linkage operation function, meet the expansion of large-flow and high-lift systems application
Warranty	10years
Certification	UL, ISO, IEC and IEE requirements

Water pump specification: The water pump to be used at Mayanga Water scheme shall be centrifugal multistage submersible pump with a 3-phase AC-type, corrosion-resistant motor, all stainless steel exterior construction, stainless steel splined shaft, NEMA mounting dimensions, hermetically-sealed windings, water lubrication and with a pressure equalizing diaphragm

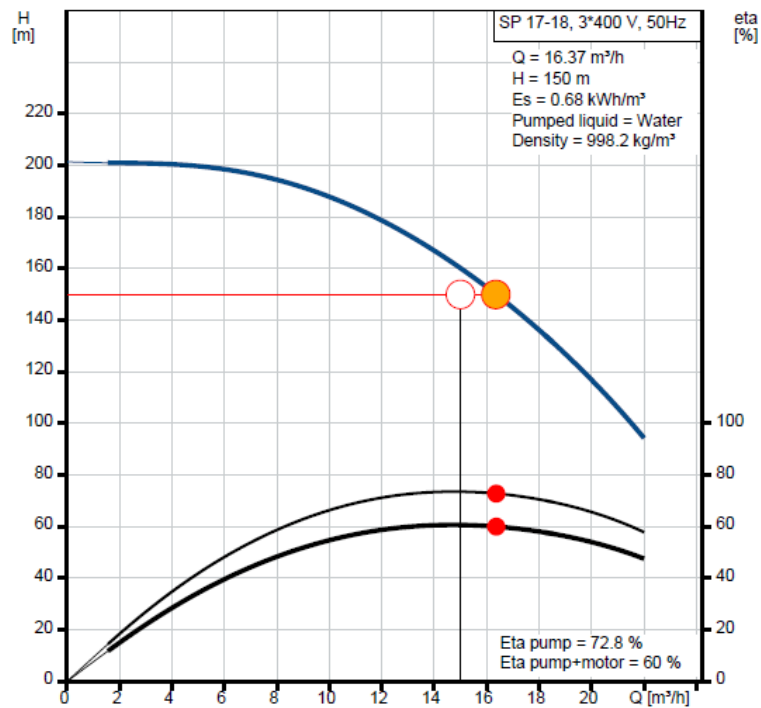

Figure 4-11; Variable speed performance curve of the pump selected for Mayanga Water System

The pump end shall be constructed from centrifugal multistage direct-coupled pump end, with non-return valve, of material: stainless steel (AISI 304), rubber, dry running protection, shall withstand maximum sand content of 50 g/m³, maximum salt content of 300-500 ppm at maximum 30°C, with water pH value of 6-9 and shall be of high life expectancy

Table 4-9: Water pump specifications for Mayanga Water System

Parameter	Characteristics
Pump type	Submersible, Multistage Centrifugal pump
Pumping Requirements (Q-H)	15.0m ³ /hr at 150m head
Pumping Duration	10 hours [Max. 5.7 sun peak hours using solar energy]
Rated Power of Pump	11.0kW at Full-load conditions, 72.8% eta-pump
Specific Energy consumption	4.53Wh/m ³ /m and 0.6798kWh/m ³

Motor type	Variable speed/frequency controlled
Phases	3 phase
Voltage	380-400-415 V
Frequency:	50 Hz [Variable speed +3Hz]
Current (rated)	25.0A
Power factor (actual)	0.78 at rated current
Water max temp	40°C

4.7.2 Design summary for Mayanga Energy Package

The table below shows the design summary of the solar-PV energy package that matches the specified inverter and pump to abstract as much water as possible within the limits of the available borehole well

Item	Particulars
Pump Size	Qmax=15.0m ³ /hr, H=150m, 11kW, 25.0A, 415V/ 50Hz
Inverter Size	15.0kW,415V/ 50Hz, 30Amps
Solar Array Size	23.6kWp/4x9.29Amps/ 630Vmp, 4x20pcs rated 295Wp/ 31.7V/ 9.29amp
Energy generated	100.8kWh/day
Total estimated Water yield of package	Average=107.9m ³ /day, Max=117.8m ³ /day

The figure below shows the daily performance of the energy package

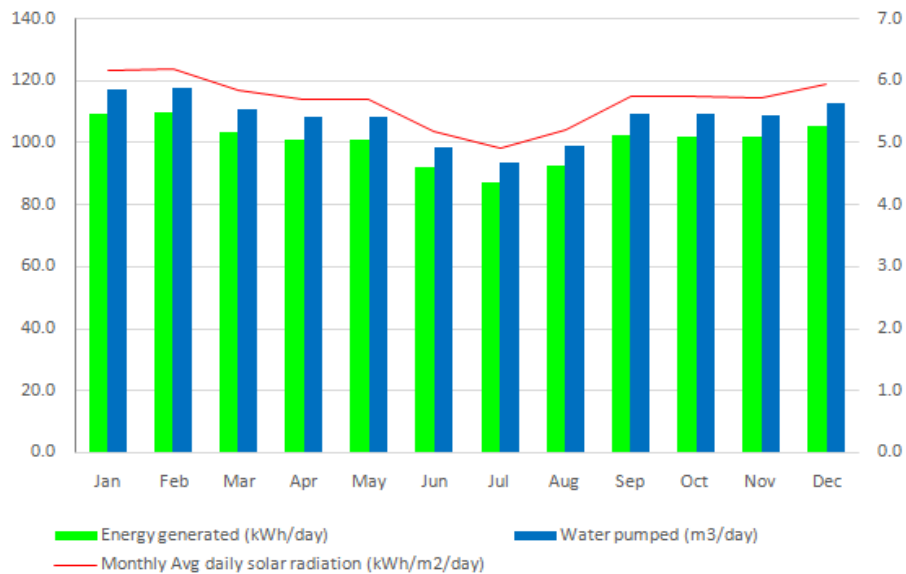

Figure 4-12; Daily Water pumping performance of the Mayanga energy package

4.8 Ssekanyonyi Water Supply System

4.8.1 Energy System Specifications for Ssekanyonyi Water Supply System

Array power output: the minimum power to be supplied by the array to power the water pump shall be atleast 4.0kW at a solar isolation of 5.7kWh/m²/day for a solar-PV Energy package of 11.8kWp and shall meet the following technical particulars

Parameter	Characteristics
Solar module rating	295Wp/ 31.7V/ 9.29amp
System voltage configuration	V_{mpp} : 630V _{DC}
The solar-PV array power rating	11.8kWp
# of solar modules to supply required power	2x20pieces (1 string consists 20 modules)
Solar module material	Mono/ Poly crystalline Silicon
Solar module warranty	25years
Solar module certification	UL, ISO, IEC and IEE requirements

Inverter specification: the inverter to be supplied and installed will be a three phase DC-AC variable speed drive for direct interconnection with the solar array with MPPT power control algorithm.

Parameter	Characteristics
DC Input voltage	V_{mpp} : 500-700V _{DC} V_{max} : 850V _{VOC}
AC Input voltage	3PH 415V _{ac} ; 50Hz
Rated Power output	7.5kW at 98% efficiency at full load, 0.95pf; 50Hz (Variable speed, +5hz selectable speed increase)
Output voltage	18A, 3PH 380-440V 50Hz
Power control	Based on IGBTs for digital signal processing, with Pulse-width modulation
Power control algorithm	Maximum Power Point Tracking
Protection Grade	IP65
Other features	Compatible with submersible pumps, surface pumps, using induction motors; 8 years' storage capacity for operation data. Support soft start of pump. Full motor protections; water level switch to protect overflow and dry running; Support PV/AC power complementary input, with solar priority function selection which can meet the requirement of 24 hours application while the priority is given to the maximum utility of solar energy and the AC power supply is automatically shielded to achieved the goal of main power saving; Support

	multi-pump linkage operation function, meet the expansion of large-flow and high-lift systems application
Warranty	10years
Certification	UL, ISO, IEC and IEE requirements

Water pump specification: The water pump to be used at Ssekanyonyi Water scheme shall be centrifugal multistage submersible pump with a 3-phase AC-type, corrosion-resistant motor, all stainless steel exterior construction, stainless steel splined shaft, NEMA mounting dimensions, hermetically-sealed windings, water lubrication and with a pressure equalizing diaphragm

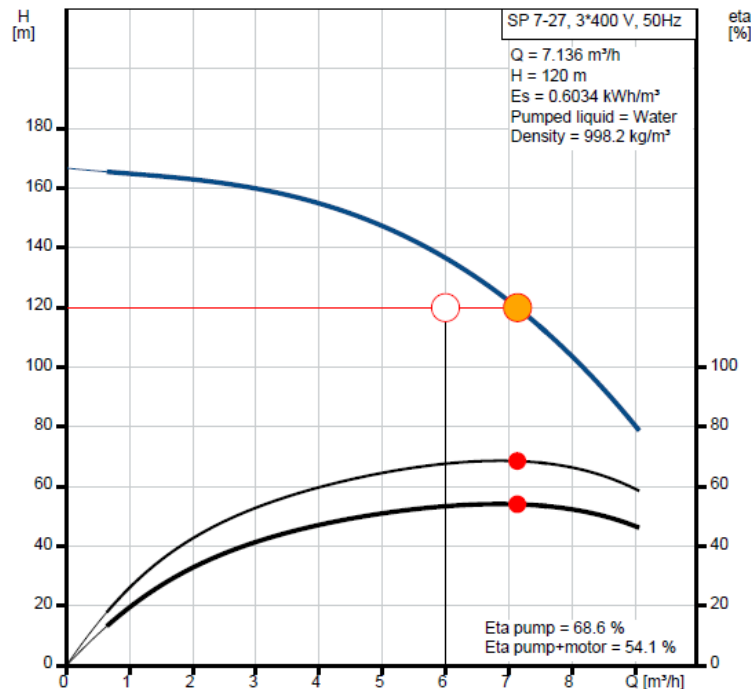

Figure 4-13; Variable speed performance curve of the pump selected for Ssekanyonyi Water System

The pump end shall be constructed from centrifugal multistage direct-coupled pump end, with non-return valve, of material: stainless steel (AISI 304), rubber, dry running protection, shall withstand maximum sand content of 50 g/m³, maximum salt content of 300-500 ppm at maximum 30°C, with water pH value of 6-9 and shall be of high life expectancy

Table 4-10: Water pump specifications for Ssekanyonyi Water System

Parameter	Characteristics
Pump type	Submersible, Multistage Centrifugal pump
Pumping Requirements (Q-H)	6.0m ³ /hr at 120m head
Pumping Duration	10 hours [Max. 5.7 sun peak hours using solar energy]
Rated Power of Pump	4.0kW at Full-load conditions, 68.6% eta-pump
Specific Energy consumption	5.03Wh/m ³ /m and 0.6035kWh/m ³

Motor type	Variable speed/frequency controlled
Phases	3 phase
Voltage	380-400-415 V
Frequency:	50 Hz [Variable speed +3Hz]
Current (rated)	9.6 A
Power factor (actual)	0.75 at rated current
Water max temp	40°C

4.8.2 Design summary for Ssekanyonyi Energy Package

The table below shows the design summary of the solar-PV energy package that matches the specified inverter and pump to abstract as much water as possible within the limits of the available borehole well

Item	Particulars
Pump Size	Qmax=6.0m ³ /hr, H=120m, 4.0kW, 9.6A, 415V/ 50Hz
Inverter Size	7.5kW,415V/ 50Hz, 18Amps
Solar Array Size	11.8kWp/2x9.29Amps/ 630Vmp, 2x20pcs rated 295Wp/ 31.7V/ 9.29amp
Energy generated	50.4kWh/day
Total estimated Water yield of package	Average=57.3m ³ /day, Max=62.5m ³ /day

The figure below shows the daily performance of the energy package

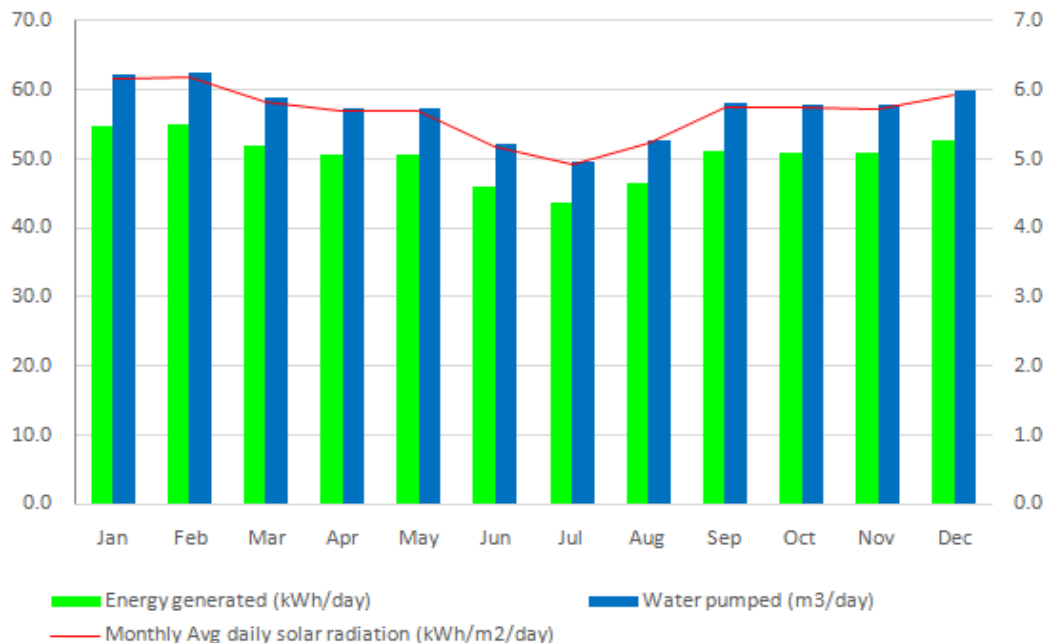

Figure 4-14; Daily Water pumping performance of the Ssekanyonyi energy package

4.9 Buyende-2 Water Supply System

4.9.1 Energy System Specifications for Buyende-2 Water Supply System

Array power output: the minimum power to be supplied by the array to power the water pump shall be atleast 2.2kW at a solar isolation of 5.7kWh/m²/day for a solar-PV Energy package of 5.9kWp and shall meet the following technical particulars

Parameter	Characteristics
Solar module rating	295Wp/ 31.7V/ 9.29amp
System voltage configuration	V_{mpp} : 630V _{DC}
The solar-PV array power rating	5.9kWp
# of solar modules to supply required power	1x20pieces (1 string consists 20 modules)
Solar module material	Mono/ Poly crystalline Silicon
Solar module warranty	25years
Solar module certification	UL, ISO, IEC and IEE requirements

Inverter specification: the inverter to be supplied and installed will be a three phase DC-AC variable speed drive for direct interconnection with the solar array with MPPT power control algorithm.

Parameter	Characteristics
DC Input voltage	V_{mpp} : 500-700V _{DC} V_{max} : 850V _{VOC}
AC Input voltage	3PH 415V _{ac} ; 50Hz
Rated Power output	3.7kW at 98% efficiency at full load, 0.95pf; 50Hz (Variable speed, +5hz selectable speed increase)
Output voltage	9A, 3PH 380-440V 50Hz
Power control	Based on IGBTs for digital signal processing, with Pulse-width modulation
Power control algorithm	Maximum Power Point Tracking
Protection Grade	IP65
Other features	Compatible with submersible pumps, surface pumps, using induction motors; 8 years' storage capacity for operation data. Support soft start of pump. Full motor protections; water level switch to protect overflow and dry running; Support PV/AC power complementary input, with solar priority function selection which can meet the requirement of 24 hours application while the priority is given to the maximum utility of solar energy and the AC power supply is automatically shielded to achieved the goal of main power saving; Support

	multi-pump linkage operation function, meet the expansion of large-flow and high-lift systems application
Warranty	10years
Certification	UL, ISO, IEC and IEE requirements

Water pump specification: The water pump to be used at Buyende-2 Water scheme shall be centrifugal multistage submersible pump with a 3-phase AC-type, corrosion-resistant motor, all stainless steel exterior construction, stainless steel splined shaft, NEMA mounting dimensions, hermetically-sealed windings, water lubrication and with a pressure equalizing diaphragm

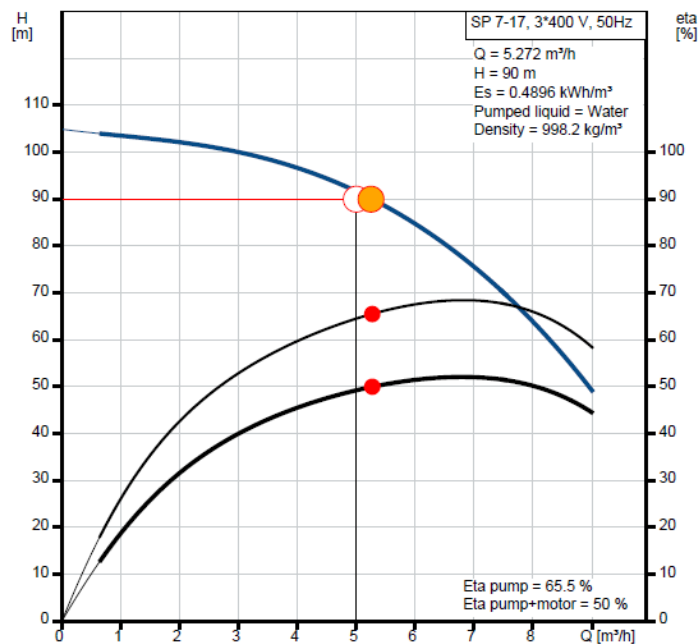

Figure 4-15; Variable speed performance curve of the pump selected for Buyende-2 Water System

The pump end shall be constructed from centrifugal multistage direct-coupled pump end, with non-return valve, of material: stainless steel (AISI 304), rubber, dry running protection, shall withstand maximum sand content of 50 g/m³, maximum salt content of 300-500 ppm at maximum 30°C, with water pH value of 6-9 and shall be of high life expectancy

Table 4-11: Water pump specifications for Buyende-2 Water System

Parameter	Characteristics
Pump type	Submersible, Multistage Centrifugal pump
Pumping Requirements (Q-H)	5.0m ³ /hr at 90m head
Pumping Duration	10 hours [Max. 5.7 sun peak hours using solar energy]
Rated Power of Pump	2.2kW at Full-load conditions, 65.5% eta-pump
Specific Energy consumption	5.44Wh/m ³ /m and 0.4896kWh/m ³
Motor type	Variable speed/ frequency controlled

Phases	3 phase
Voltage	380-400-415 V
Frequency:	50 Hz [Variable speed +3Hz]
Current (rated)	5.5 A
Power factor (actual)	0.78 at rated current
Water max temp	40°C

4.9.2 Design summary for Buyende-2 Energy Package

The table below shows the design summary of the solar-PV energy package that matches the specified inverter and pump to abstract as much water as possible within the limits of the available borehole well

Item	Particulars
Pump Size	Qmax=5.0m ³ /hr, H=90m, 2.2kW, 5.5A, 415V/ 50Hz
Inverter Size	3.7kW,415V/ 50Hz, 9Amps
Solar Array Size	5.9kWp/1x9.29Amps/ 630Vmp, 1x20pcs rated 295Wp/ 31.7V/ 9.29amp
Energy generated	23.8kWh/day
Total estimated Water yield of package	Average=33.7m ³ /day, Max=36.9m ³ /day

The figure below shows the daily performance of the energy package

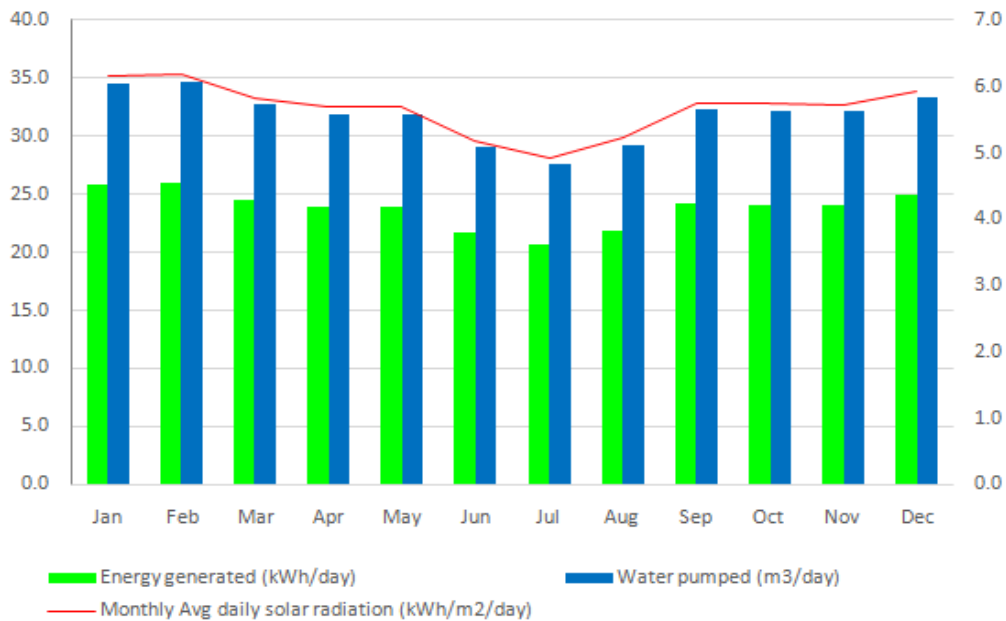

Figure 4-16; Daily Water pumping performance of the Buyende-2 energy package

4.10 Kagulu Water Supply System

4.10.1 Energy System Specifications for Kagulu Water Supply System

Array power output: the minimum power to be supplied by the array to power the water pump shall be atleast 7.5kW at a solar isolation of 5.7kWh/m²/day for a solar-PV Energy package of 17.7kWp and shall meet the following technical particulars

Parameter	Characteristics
Solar module rating	295Wp/ 31.7V/ 9.29amp
System voltage configuration	V_{mpp} : 630V _{DC}
The solar-PV array power rating	17.7kWp
# of solar modules to supply required power	3x20pieces (1 string consists 20 modules)
Solar module material	Mono/ Poly crystalline Silicon
Solar module warranty	25years
Solar module certification	UL, ISO, IEC and IEE requirements

Inverter specification: the inverter to be supplied and installed will be a three phase DC-AC variable speed drive for direct interconnection with the solar array with MPPT power control algorithm.

Parameter	Characteristics
DC Input voltage	V_{mpp} : 500-700V _{DC} V_{max} : 850V _{VOC}
AC Input voltage	3PH 415V _{ac} ; 50Hz
Rated Power output	11.0kW at 98% efficiency at full load, 0.95pf; 50Hz (Variable speed, +5hz selectable speed increase)
Output voltage	24A, 3PH 380-440V 50Hz
Power control	Based on IGBTs for digital signal processing, with Pulse-width modulation
Power control algorithm	Maximum Power Point Tracking
Protection Grade	IP65
Other features	Compatible with submersible pumps, surface pumps, using induction motors; 8 years' storage capacity for operation data. Support soft start of pump. Full motor protections; water level switch to protect overflow and dry running; Support PV/AC power complementary input, with solar priority function selection which can meet the requirement of 24 hours application while the priority is given to the maximum utility of solar energy and the AC power supply is automatically shielded to achieved the goal of main power saving; Support

	multi-pump linkage operation function, meet the expansion of large-flow and high-lift systems application
Warranty	10years
Certification	UL, ISO, IEC and IEE requirements

Water pump specification: The water pump to be used at Kagulu Water scheme shall be centrifugal multistage submersible pump with a 3-phase AC-type, corrosion-resistant motor, all stainless steel exterior construction, stainless steel splined shaft, NEMA mounting dimensions, hermetically-sealed windings, water lubrication and with a pressure equalizing diaphragm

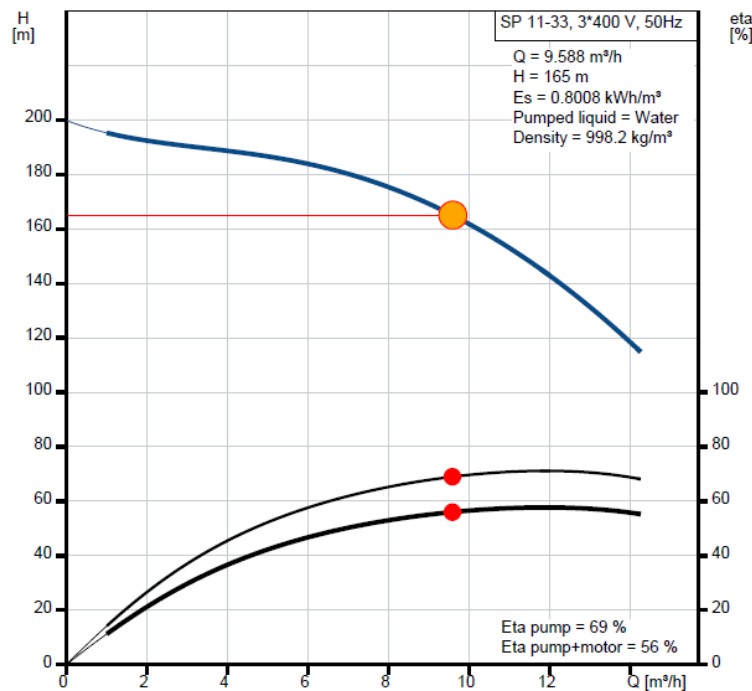

Figure 4-17; Variable speed performance curve of the pump selected for Kagulu Water System

The pump end shall be constructed from centrifugal multistage direct-coupled pump end, with non-return valve, of material: stainless steel (AISI 304), rubber, dry running protection, shall withstand maximum sand content of 50 g/m³, maximum salt content of 300-500 ppm at maximum 30°C, with water pH value of 6-9 and shall be of high life expectancy

Table 4-12: Water pump specifications for Kagulu Water System

Parameter	Characteristics
Pump type	Submersible, Multistage Centrifugal pump
Pumping Requirements (Q-H)	10.0m ³ /hr at 165m head
Pumping Duration	10 hours [Max. 5.7 sun peak hours using solar energy]
Rated Power of Pump	7.5kW at Full-load conditions, 69.0% eta-pump
Specific Energy consumption	4.83Wh/m ³ /m and 0.7966kWh/m ³

Motor type	Variable speed/frequency controlled
Phases	3 phase
Voltage	380-400-415 V
Frequency:	50 Hz [Variable speed +3Hz]
Current (rated)	17.2 A
Power factor (actual)	0.78 at rated current
Water max temp	40°C

4.10.2 Design summary for Kagulu Energy Package

The table below shows the design summary of the solar-PV energy package that matches the specified inverter and pump to abstract as much water as possible within the limits of the available borehole well

Item	Particulars
Pump Size	Qmax=9.59m ³ /hr, H=165m, 7.5kW, 17.2A, 415V/ 50Hz
Inverter Size	11.0kW,415V/ 50Hz, 24Amps
Solar Array Size	17.7kWp/3x9.29Amps/ 630Vmp, 3x20pcs rated 295Wp/ 31.7V/ 9.29amp
Energy generated	75.6kWh/day
Total estimated Water yield of package	Average=65.5m ³ /day, Max=71.5m ³ /day

The figure below shows the daily performance of the energy package

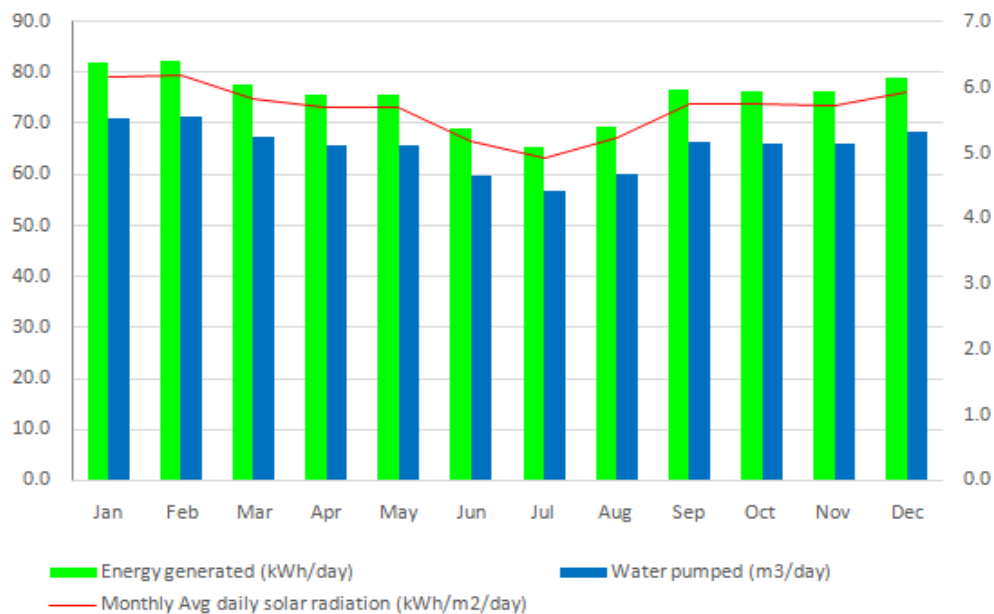

Figure 4-18; Daily Water pumping performance of the Kagulu energy package

4.11 Kasambira Water Supply System

4.11.1 Energy System Specifications for Kasabira Water Supply System

Array power output: the minimum power to be supplied by the array to power the water pump shall be atleast 5.5kW at a solar isolation of 5.7kWh/m²/day for a solar-PV Energy package of 11.8kWp and shall meet the following technical particulars

Parameter	Characteristics
Solar module rating	295Wp/ 31.7V/ 9.29amp
System voltage configuration	V_{mpp} : 630V _{DC}
The solar-PV array power rating	11.8kWp
# of solar modules to supply required power	1x20pieces (1 string consists 20 modules)
Solar module material	Mono/ Poly crystalline Silicon
Solar module warranty	25years
Solar module certification	UL, ISO, IEC and IEE requirements

Inverter specification: the inverter to be supplied and installed will be a three phase DC-AC variable speed drive for direct interconnection with the solar array with MPPT power control algorithm.

Parameter	Characteristics
DC Input voltage	V_{mpp} : 500-700V _{DC} V_{max} : 850V _{VOC}
AC Input voltage	3PH 415V _{ac} ; 50Hz
Rated Power output	7.5kW at 98% efficiency at full load, 0.95pf; 50Hz (Variable speed, +5hz selectable speed increase)
Output voltage	18A, 3PH 380-440V 50Hz
Power control	Based on IGBTs for digital signal processing, with Pulse-width modulation
Power control algorithm	Maximum Power Point Tracking
Protection Grade	IP65
Other features	Compatible with submersible pumps, surface pumps, using induction motors; 8 years' storage capacity for operation data. Support soft start of pump. Full motor protections; water level switch to protect overflow and dry running; Support PV/AC power complementary input, with solar priority function selection which can meet the requirement of 24 hours application while the priority is given to the maximum utility of solar energy and the AC power supply is automatically shielded to achieved the goal of main power saving; Support

	multi-pump linkage operation function, meet the expansion of large-flow and high-lift systems application
Warranty	10years
Certification	UL, ISO, IEC and IEE requirements

Water pump specification: The water pump to be used at Kasambira Water scheme shall be centrifugal multistage submersible pump with a 3-phase AC-type, corrosion-resistant motor, all stainless steel exterior construction, stainless steel splined shaft, NEMA mounting dimensions, hermetically-sealed windings, water lubrication and with a pressure equalizing diaphragm

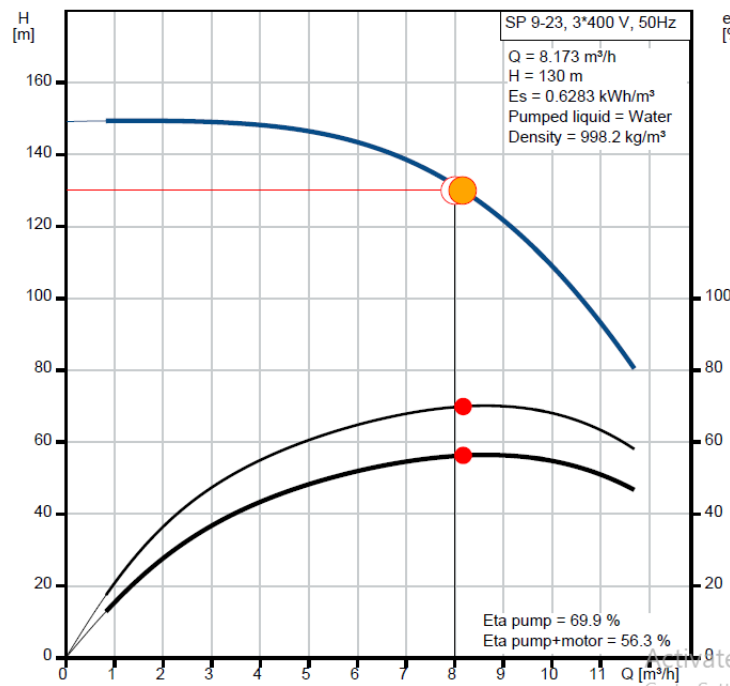

Figure 4-19; Variable speed performance curve of the pump selected for Kasambira Water System

The pump end shall be constructed from centrifugal multistage direct-coupled pump end, with non-return valve, of material: stainless steel (AISI 304), rubber, dry running protection, shall withstand maximum sand content of 50 g/m³, maximum salt content of 300-500 ppm at maximum 30°C, with water pH value of 6-9 and shall be of high life expectancy

Table 4-13: Water pump specifications for Kasambira Water System

Parameter	Characteristics
Pump type	Submersible, Multistage Centrifugal pump
Pumping Requirements (Q-H)	8.0m ³ /hr at 130m head
Pumping Duration	10 hours [Max. 5.7 sun peak hours using solar energy]
Rated Power of Pump	5.5kW at Full-load conditions, 69.9% eta-pump
Specific Energy consumption	4.83Wh/m ³ /m and 0.6283kWh/m ³

Motor type	Variable speed/frequency controlled
Phases	3 phase
Voltage	380-400-415 V
Frequency:	50 Hz [Variable speed +3Hz]
Current (rated)	13.0A
Power factor (actual)	0.72 at rated current
Water max temp	40°C

4.11.2 Design summary for Kasambira Energy Package

The table below shows the design summary of the solar-PV energy package that matches the specified inverter and pump to abstract as much water as possible within the limits of the available borehole well

Item	Particulars
Pump Size	Qmax=8.0m ³ /hr, H=130m, 5.5kW, 13.0A, 415V/ 50Hz
Inverter Size	7.5kW,415V/ 50Hz, 18Amps
Solar Array Size	11.8kWp/2x9.29Amps/ 630Vmp, 2x20pcs rated 295Wp/ 31.7V/ 9.29amp
Energy generated	50.8kWh/day
Total estimated Water yield of package	Average=56.1m ³ /day, Max=61.2m ³ /day

The figure below shows the daily performance of the energy package

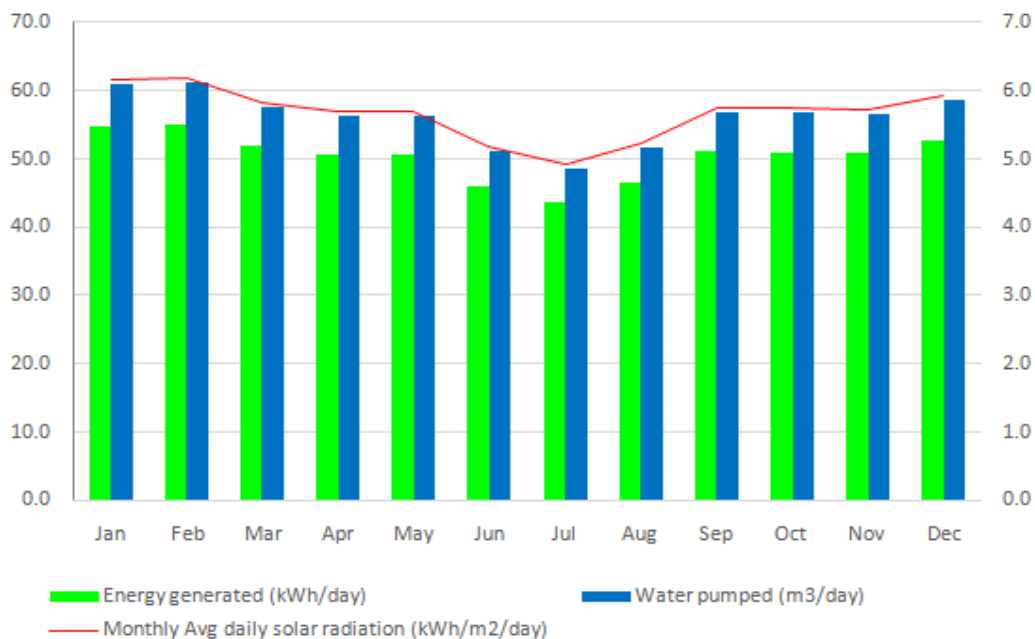

Figure 4-20; Daily Water pumping performance of the Kasambira energy package

5 Employer's Requirements

5.1 Transport Vehicle

The Contractor shall avail under lease 1 No. Station Wagon vehicle which shall be for the sole use of the Employer's Supervision team over the entire Time for completion of the works (15 months) and defects liability period (24 months) as specified in the Particular Conditions of Contract PCC 8.2 (Time for commencement and completion), and shall be available at all times. The vehicle shall be comprehensively insured, fueled and properly serviced and maintained at all times, and in proper working conditions.

Only those makes of vehicles having satisfactory permanent repair and maintenance facilities already well established in Kampala will be acceptable and shall first be approved by the Engineer. The vehicle shall be new right-hand drive diesel-powered vehicle. It shall have four-wheel drive capability, high ground clearance, an engine capacity of at least 2800 cc, power steering, power windows, anti-lock braking system, air bags for driver and front passenger, lockable glove box, and central locking system. The front seats shall be separate and all seats shall have headrests. The vehicle shall be fitted with the manufacturer's tropical and off-highway extras including tow bars, front bull bars and air conditioning. The vehicle shall be equipped with an auto alarm system, central locking system and radio and compact disc facilities.

The vehicle shall also be provided with a first aid kit supplied by the supplier of the vehicles. Kerb weight and tyre pressures shall be stated on the vehicle, and the vehicle shall conform in all respects to the regulations of the appropriate registration authority. The station wagon shall be fully covered with permanent rooves and have adequate seating for a driver and six passengers. The station wagon shall have wireless key and remote, switch for four-wheel drive, and side impact protection bars.

The Contractor shall provide a competent English-speaking driver to the approval of the Engineer. The driver shall have a minimum continuous driving experience of 8 years, with a certificate in defensive driving, and aged between 30 and 55 years old. Any driver found unsuitable by the Engineer shall be replaced immediately. The driver shall be available during all normal site working hours and when specifically required outside those hours.

5.2 Employer's Due Diligence & Witness Testing

The Contractor shall plan, coordinate, facilitate due diligence and witness testing activities for the Employer to inspect and verify all the sources and manufacturers of key components including power inverters, water pumps, solar PV modules and remote monitoring systems; and to witness/participate in the testing of the items at

the manufacturer's factory to ensure that the required level of performance shall be achieved after installation. The Employer's team shall comprise of the 2 Members from the Supervising Consultant's team and 3 Members of the Employer's Project Management Team.

5.3 Implementation of Environmental & Social Management Plan

The implementation of the Environmental & Social Management Plan (ESMP) as detailed in Volume 5 will be done in collaboration with the Employer and the Engineer. The Contractor will be expected to have a team of qualified expert as provided in Form PER-1 at all times during the implementation. The contractor is expected to undertake the following activities;

5.3.1 Surveying and Verification

The Contractor will be required to survey and open boundaries for sites where the boundaries don't exist and to verify the ownership of the land prior to mobilizing on the site. The contractor will be required to carry out surveys to determine whether any services such as pipelines, powerline, building foundations, graves, cultural artifacts, crops etc. exist on the site and to take an inventory of them.

5.3.2 Crop Compensations

The Contractor will be required to take stock of all the crops existing on the site prior to clearing the ground and provide the information to the Engineer for review and recommendation for compensation.

5.3.3 Site Management and Security

The Contractor will be required to provide and manage the access to the site and to provide full time security during the implementation of the works.

5.3.4 Management/Relocation of existing services, artifacts or cultural property

The Contractor will be required to manage/safely relocate any existing services such as water pipelines, graves, cultural property or other structures.

5.3.5 Source protection

The contractor will be required to protect the borehole water source from any contaminants during the implementation of the works by controlling runoff water and preventing waste from entering the borehole.

5.3.6 Control of Influx of Job Seekers

The Contractor will be required to have a recruitment plan in place and implement it to avoid influx of job seeker at the construction site.

5.3.7 Control of Exploitation of workers and Underage employment

The Contractor should ensure that no underage persons are recruited to work on the site by strictly enforcing their recruitment plan. The Contract should ensure that no workers on the sites are exploited through low pay, long working hours and lack of breaks between intensive work activities.

5.3.8 Control of spread of HIV/AIDS

The Contractor is expected to conduct training and testing of HIV/AIDS at all sites at least once every three months. The Contractor should ensure that there is an adequate supply of Condoms at all sites throughout the during of the works. The Contractor should ensure each site has adequate signages and information posters that are clearly translated in the language of the respective region where the site is located.

5.3.9 Control of Gender Based Violence and Sexual Harassment

The Contractor has to put a mechanism in place to control, manage and deal with any cases of GBV and or Sexual Harassment on the sites.

5.3.10 Public health management

The Contractor has to ensure a high level of public health and cleanliness on the sites is maintained by providing appropriate solid and liquid waste management mechanisms, carrying out routine testing of communicable diseases among workers, and reporting any cases of disease outbreaks to the relevant authorities. The Contractor must have medical emergencies mechanism on the site to respond to cases of accidents / health emergencies that may occur on the sites.

5.3.11 Worker's livelihood Mental health management

The Contractor is expected to ensure the well-being of all workers on the site by undertaking at least 1 assessment and counselling session for workers on the site.

5.3.12 Waste Management

The Contractor is expected to have a proper waste management plan for all types of waste that is expected to be generated during the implementation period.

5.3.13 Protection from electrocution

The Contractor is expected to implement a plan to protect all workers and people who visit the site from electrocution during and after implementation of the works.

5.3.14 Soil erosion protection (Grass planting)

The Contractor is expected to design the compound around the Solar Arrays and plant the approved type of grass.

5.3.15 Tree planting

The Contractor is expected to plant and continue watering 5 approved trees within the site area. The Contractor has to ensure the tree are located appropriately to avoid shedding the solar panels.

5.3.16 Community meetings

The Contractor is expected to coordinate and facilitate at least one community meeting every month for each site for approximately 50 people.

5.3.17 ESMP Reporting

The Contractor is expected to report on the implementation of the ESMP for all the sites every month. The contractor is expected to submit soft copy versions of the reports for review and subsequently submit 5 hard copies of the final report each month.

5.4 Site Access and Land Easement

The Contractor is required to create access to the sites where direct access is not possible by clearing and creating a firm gravel surface access road of at least 5m width and for not more than 500m length for each site for use during the implementation of the works.

5.5 Training requirements

Generally, training will be done in collaboration with the Owner's engineer/consultant. Hands-on training will be provided at the construction site so that, all O&M personnel are well prepared to take-over the operation as well as some general repairs for the power plant after the Contractor has handed over the facilities. The Contractor will be expected to carry out a one-day training session for each of the 10 schemes, targeting 10 participants for each scheme. The Contractor is expected to fully facilitate the training, and to facilitate the participants during the training, i.e., provision of training materials, refreshments and transport refunds where applicable.

After system testing and pre-commissioning, all scheme operators will convene at the site for to be trained in operation and maintenance skills, as well as troubleshooting for faults finding. This training shall be repeated six months within the defects liability period as well as in the 12 month time when defects liability is about to expire. The continued re-training ensures that refresher knowledge and skills are imparted into scheme operators, and this also gives an opportunity for all operators to share experiences, challenges and find common solutions to all problems. Also, it helps in picking up based case practices, which others have used to achieve success.

Several charts and training manuals will be drafted by the Owner's Engineer, in well animated presentation, to provide live examples for which certain maintenance

techniques are for each of the individual system components, including the precautions to be taken, and the regularity.

Task	Task name	Personnel	
		Responsible	Contributing
A.1	Training and Institutional Support: Capacity gaps identification Information manuals Guidelines for Renewable energy packages for Water-pumping Awareness and information dissemination O&M Manuals	Contractor (<i>Electrical and Water Engineer</i>), Owner's engineer, Sociologist	MWE project coordinator, MWE Sociologist, District Water officer Project Manager

The contractor is expected to provide the engineers and technicians who will carry out practical demonstrations on site, and also engage the trainees in practical fault finding and troubleshooting, plus simulated repairs or replacement of parts. All these activities shall take place at the respective water scheme of each benefiting community.

5.6 Design and Production of IEC materials and Manuals

The Contractor, with guidance from the Engineer, is required to design and produce Information, Education and Communication materials and Operation and Maintenance Manuals of the Solar Energy Packages, pumping system and remote monitoring system for use by the scheme operators and the Employer. For each of the schemes the Contractor will be required to design and produce the following;

S/n	Type of IEC material	Quality/Material	Dimensions	Quantities
1	Wall Charts, printed in full colour, indicating procedures for O&M of system components	Self-sticking Water Proof glossy paper or flexible PVC	A2	5 pieces
2	Solar PV Energy Package and Pumping System Layout	Water Proof flexible PVC	A0	1 piece
3	Tear Drop Banner (including all associated structural components for its erection and storage)	Water Proof textile or flexible PVC	Standard Dimension	2 pieces

	with Project Information			
4	Pull Up Banner (including all associated structural components for its erection and storage) with Project Information	Water Proof flexible PVC	Standard Dimension	2 pieces
5	Foldable Information Sheet/Flyer	Water Proof glossy paper	A4	50 pieces
6	Well bound Operation and Maintenance Manual Booklet in full colour. The Manual should include Data Sheets and Troubleshooting procedures for all the components	Normal Printing Paper	A4	5 books
7	Component Name Plates	Information engraved in Water Proof Hard PVC to be affixed on Walls/Structures by tough bond glue	As Appropriate in easily readable uppercase bold font	For all individual components and building structures

5.7 Testing and Commissioning

The Contractor in collaboration with the Engineer and the Employer will plan, coordinate, facilitate and implement Employers' operational system testing, pre-commissioning, Operational acceptance monitoring, plus final commissioning and handover of facility for all schemes in Lot.

5.7.1 Testing

The Contractor will be required to plan and facilitate a two day's system operational testing for each of the schemes for the participation of the Employer and the Engineer. The Activity will involve the participation of 5 representatives from the Employer and 3 representatives from the Supervising Consultant. The Contractor will be required to coordinate the operational acceptance testing period and facilitate the all testing and monitoring activities by the Employer.

5.7.2 Commissioning

The Contractor will be required to plan and facilitate a one day's commissioning and handover activity for each of the schemes for the participation of the All key stakeholders including the District, Towns, Umbrella, Employer and the Engineer. The Activity will involve the participation of approximately 50 people for each scheme.