

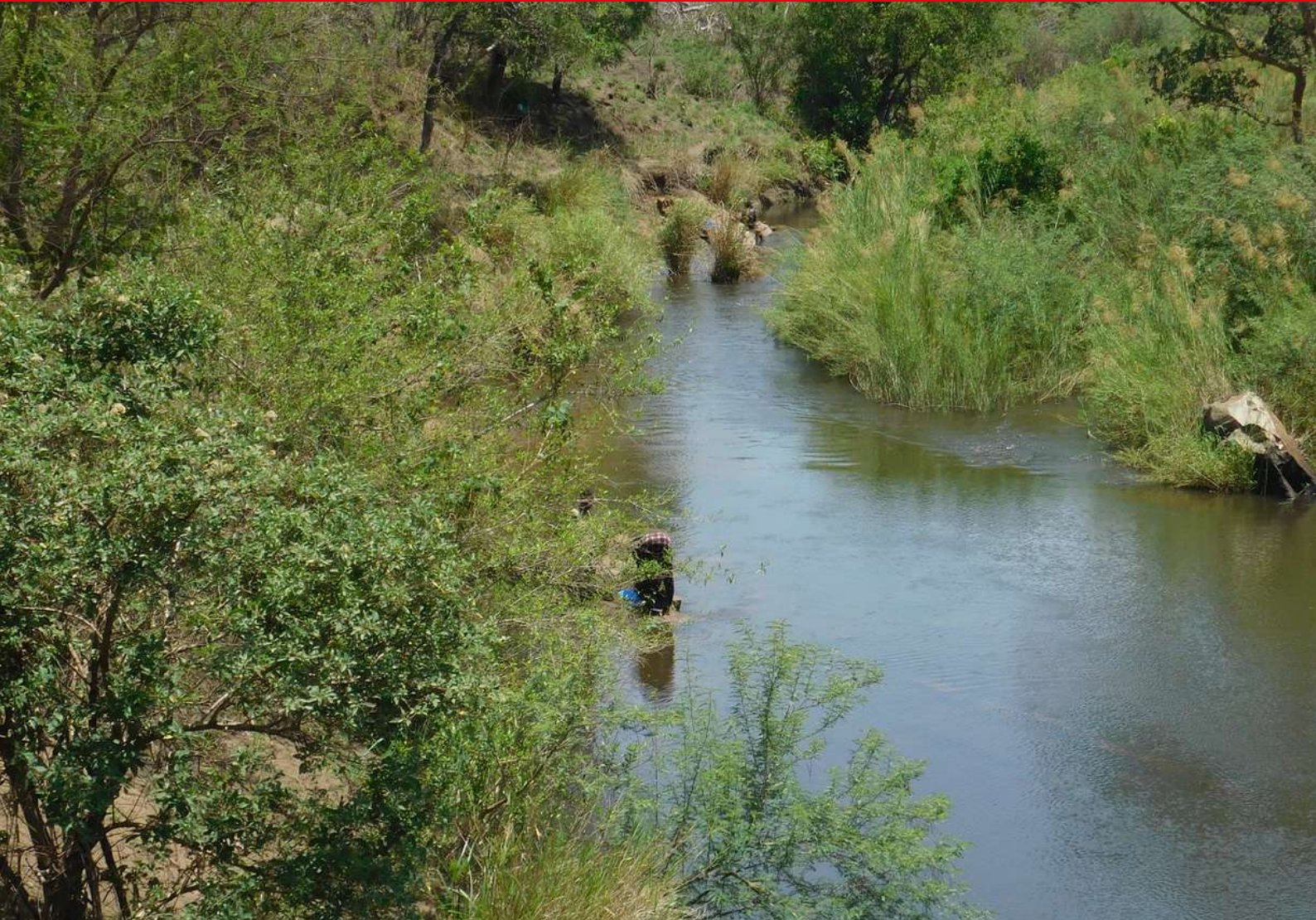

Ministry of Water and Environment
Directorate of Water Resources Management
Upper Nile Water Management Zone



Aswa
Catchment Management Plan

FOREWORD



Hon. Sam Cheptoris

Minister of Water and Environment
The Republic of Uganda

Water resources support key sectors of the economy namely hydropower generation, agriculture, fisheries, domestic water supply, industry, navigation etc. However, efficiency and sustainability of intervention under these sectors has recently been a concern in Uganda mainly due to inadequate sectoral collaboration in planning and implementation, increasing frequency of floods and droughts, environmental degradation and pollution of water resources. This situation therefore calls for development of mechanisms for promoting integrated planning, development and management of water resources so as to create synergy among various sectors, promote efficiency in utilization of available resources, reduce water and environmental degradation and ensure more efficient utilization of water resources to meet various social and economic demands.

In 2011, my Ministry embarked on preparation of Catchment Management Plans (CMPs) as tools for ensuring equitable access to, and use of water resources, and safeguard of key natural resources for sustainable socio-economic development of the country.

A CMP provides a long-term strategy for sustainable development and utilization of water and related resource. Catchment based water resources planning and management is in line with the Integrated Water Resources Management (IWRM) paradigm, which ensures that land, water, and related resources are developed and managed in a coordinated manner without compromising sustainability of vital ecosystems. As the lead agency for implementation of Catchment based Water Resources Management (CbWRM) in Uganda, my ministry through the Directorate of Water Resources Management (DWRM) is operationalizing the CbWRM framework through the four Water Management Zones of Albert, Kyoga, Upper Nile and Victoria WMZ.

In order to develop this CMP, a number of studies were undertaken which included an assessment of the existing catchment knowledge base, the current and projected water resources situation, the catchment's social and environmental assessment, and stakeholder engagement. The CMP identifies critical issues, challenges, opportunities, and threats within the catchment which need to be addressed to ensure the socio-economic development of the people.

Guided by the key issues, challenges, threats, opportunities, key water resources planning principles and national strategies, the stakeholders developed a vision for the catchment. To achieve the vision, stakeholders came up with a number of strategic objectives, options and actions that need to be pursued in the short, medium and long term up to the year 2040.

Aswa Catchment Management Plan was developed in 2016 following the Uganda Catchment Planning Guidelines of 2014 and was endorsed by the Aswa Catchment Management Committee (CMC) in the same year.

My Ministry is therefore pleased to formally make this CMP available for use by various stakeholders. It will enormously help and guide all developers and users of water and related resources at the national and local levels. I therefore wish to call upon all the relevant government ministries and agencies at both national and local levels, the civil society, the private sector, academia and research institutions, cultural institutions, religious institutions and the local communities to utilize this plan in order to optimally plan for the development and management of water and related resources for prosperity.

In line with the provisions of Section 5 of the Water Act, Cap 152 I therefore formally approve this Catchment Management Plan for use by various stakeholders.

For God and My Country

ACKNOWLEDGEMENTS

I would like to thank the Directorate of Water Resources Management for spearheading the preparing of Catchment Management Plans in Uganda. This is a stakeholders' driven process that is key in ensuring that water resources are effectively planned for and sustainably developed and managed so as to support the achievement of the country's vision 2040.

Special thanks go to all the stakeholders at the national, regional and local levels for their active participation and involvement in preparation of this plan. Special appreciation goes to the Upper Nile Water Management Zone for coordinating the plan preparation process and the Aswa Catchment Management Organisation through the Aswa Catchment Management Committee for ensuring that the plan is stakeholders' driven and addresses the needs of the people in the catchment.

Finally, I wish to thank the World Bank through the Water Management and Development Project for providing the funding that enabled preparation and printing of this CMP.



A handwritten signature in blue ink, appearing to read 'Alfred Okot Okidi'.

Alfred Okot Okidi
Permanent Secretary,
Ministry of Water and Environment

EXECUTIVE SUMMARY

This is a Catchment Management Plan (CMP) for the Aswa Catchment, which is part of the Upper Nile Water Management Zone. River Aswa is a major river in north-eastern Uganda, which originates from the hills in the north-western part of Katakwi District and flows through Lira District and becomes the border between Pader and Gulu districts where its two main tributaries, River Agago and then the River Pager flow into it. The river forms most of the Uganda-South Sudan border between Atiak and Kitgum before crossing into South Sudan, east of the border town of Nimule and joining the White Nile about 10 miles northwest of Nimule.

The Aswa Catchment drains an area of 27,677 square kilometres (km²) covering 15 districts of Abim, Agago, Alebtong, Amuria, Amuru, Gulu, Kaabong, Kitgum, Kole, Kotido, Lamwo, Lira, Otuke, Oyam, and Pader in part or whole. The estimated population of all the 15 districts covered by the Aswa Catchment, based on the provisional results of the 2014 Population and Housing Census, is 3,292,176 (UBOS, 2014), and using the available spatial and statistical data, 55.45% (1,825,667 people) of these live within the catchment.

The CMP is intended to provide, as a long term strategy, a number of agreed investments in infrastructure and other interventions and actions meant to help resolve conflict, conserve and protect the catchment and its natural resources, and ensure equitable access to and sustainable use of water resources within the Aswa Catchment. The approach for the development of the CMP is in line with the Catchment Planning Guidelines 2014, which sequentially included the following key processes;

- Catchment Description and Building a Planning Knowledge Base, from which a wealth of information is gathered which informs, influences, and drives sustainable catchment management and development
- Water Resource Planning Analysis, which analyses the current and projected water availability, uses, and demand and related projections
- Stakeholder Engagement, which ensures effective stakeholder participation, issues identification and mapping and eases implementation of the CMP
- Strategic Social and Environmental Assessment, which identifies social and environmental issues that inform development and/or management measures
- Framework of Catchment Water Planning sets the scene for development and/or management interventions in light of the catchment threats, demands or opportunities
- The Options and Scenario Analysis provides an analysis of the options and the alternative sets of options that form scenarios. These scenarios are evaluated to get the best scenario which informs the investment and management interventions or agreed infrastructure investments and interventions within the Catchment Management Plan (CMP). These interventions are sequenced, costed and this forms the catchment implementation plan.

From a wealth of information gathered, assessments were conducted which revealed key facts and issues within the catchment. The Water Resource Analysis (WRA) indicates that in the mean and drought hydrological year, the current (net) water demands are satisfied for all sub-catchments in Aswa except for the dry season in the mean year for upper Pager Matidi sub-catchment (AS4a) and in the drought year for upper Moroto (AS1a), upper Agago (AS2a) and upper Pager Matidi (AS4a) sub-catchments.

In the scenarios with climate change and future (net) water demands in 2030 and 2040, there is always a sustainable use of water resources during the wet season, except for upper Pager Matidi (AS4a) in 2040.

The Strategic Social and Environmental Assessment (SSEA) indicates that there are many issues concerning the management of natural and environmental resources, such as wetlands and forests encroachment for fuel wood and cultivation, timber harvesting, bush burning for pasture rejuvenation that causes accidental forest fires, inadequate protection of wildlife outside protected areas, unclear boundary demarcation of forest reserves, refugee settlements, and many others. From the socio-economic profile, the main issues, vulnerabilities and challenges that emerged are related to high population density, heavy dependence on rain fed agriculture, climate change and variability in seasonal rainfall, refugee hotspots and related social conflicts, social conflicts related to land availability, human-wildlife conflicts and high poverty levels.

To sustainably manage and utilise the water resources within this catchment taking note of the prevailing threats, demands, and opportunities, the stakeholders set the vision for the catchment, which stems from the Upper Nile Water Management Zone vision;

"A sustainable, equitable and effective water resources management and development for socio-economic trans-formation by 2040 for the Aswa Catchment."

The vision has five sub-categories below from which strategic objectives were developed.



Water Governance is the sub-strategy that addresses the development of integrated water resources management capacity and decision making at the WMZ level including allocation, planning, regulation, monitoring, and control of water resources in a participatory and inclusive management framework



Water for People is the sub-strategy that aims at ensuring the provision of adequate water supply and sanitation and hygiene services to all the urban and rural population of the Upper Nile WMZ



Water for Production is the sub-strategy that aims at allocating water resources to productive uses for the economic development of the Upper Nile WMZ within the national framework of sectoral development goals and objectives



Water for Energy is the sub-strategy that focuses on the increase of renewable energy production through development of hydropower capacity and management of water demand for energy production



Water for Environment is the sub-strategy that aims at ensuring conservation of water related ecosystems and sustainable use natural resources within the Upper Nile WMZ

From these sub-categories, the formulated strategic objectives were:

Water Governance	1. Equitable, participatory and accountable water governance for sustainable and inclusive growth and development
Water for People	2. Universal and sustainable access to safe water supply 3. Universal and sustainable access to improved sanitation and hygiene
Water for Production	4. Sustainable use, development and management of water resources in agriculture, livestock, aquaculture, and forestry 5. Sustainable use, development and management of water resources for Agro-industry, industrial production, Oil and Gas 6. Sustainable use, development and management of water resources for other sectors (tourism, transportation, security)
Water for Energy	7. Sustainable use, development and management of water resources for renewable energy production
Water for Environment	8. Conservation of ecosystem services and functions 9. Mitigation of effects of extreme climatic events

Development and/or management measures/options were identified for the issues under each sub-category, scenarios formulated based on infrastructure development levels, and the best scenario chosen using Multi-Criteria Analysis (MCA).

Most of the investment and management actions in the CMP are common to all scenarios identified in the option analysis, while some actions are directly related to best ranked scenario including:

- Development of four large multipurpose storages (dam higher than 10m)
- Development of large irrigation schemes linked to the implementation of the large multipurpose dams
- Rehabilitation of existing silted storages
- Construction of small control dams inside wetlands
- Construction of subsurface and sand dams in Karamoja region
- Adequate facilities for 2,330,000 Livestock Topical Unit (LTU) watering provided in order to avoid water pollution, erosion on the shores of water bodies and degradation of water quality
- Small artificial ponds for aquaculture (with different extend for each scenario), considering that a part of

aquaculture can be practiced in wetlands and multipurpose storages

- Hydropower production linked to the multipurpose storages construction.

Management and investment actions were organised into 10 programme areas each with related projects managed in a coordinated way to obtain benefits and control not available from managing them individually.

No.	Programme	Summary interventions
1	Geo-database and GIS Atlas	Create a GIS infrastructure to support data storage, exchange, and information management of the Aswa Catchment. Develop technical guidelines, protocols and specifications for GIS-database population and management of spatial information.
2	Information Management System	Collect, access, analyse and share a wide range of information for the purposes of evaluating water resources and operational management.
3	Water Resource Monitoring	Collect, access, analyse and share a wide range of information for the purposes of monitoring water resources and operational management. Expand and upgrade the hydro-meteorological monitoring network, hydrogeological monitoring system and Water Quality (WQ) monitoring system. Develop an Environmental Monitoring Programme on water bodies (Surface Water and Ground Water) to determine their ecological state.
4	Water Resource Knowledge Base	Implement and maintain a comprehensive knowledge base on Water Resources and Water Resources Management through the archival of reference documents and information (paper and digital document).
5	Water Resource Planning and Regulation System	Establish and maintain the Upper Nile WMZ Modelling Unit, improve and expand the water permit management system in the WMZ/Aswa Catchment. Develop water source protection plans and promote integrated pollution prevention and control in the Upper Nile WMZ.
6	Water Sector Infrastructure & Facilities	Expand the water supply infrastructures for full coverage of urban and rural population and increase water storage capacity for domestic water supply in areas with seasonal deficits. Rehabilitate and improve functionality of existing water for production storage facilities and develop underground water storage for production in areas with water deficit. Expand irrigation schemes. Improve sanitation and hygiene facilities and implement Waste Water Treatment Plants (WWTP) or alternative wastewater treatment method. Develop water supply facilities using groundwater sources in areas with good potentialities for groundwater resources exploitation.
7	Multipurpose Water Storage Facilities	Define and operationalise a Technical Standard for design, implementation and management of multipurpose water for production storage facilities, storage facilities including recreational functions and including hydropower.
8	Integrated Water and Land Management	Promote water efficiency practices (water conservation, reuse, recycling), promote irrigation water efficiency and water conservation agricultural practices, and promote optimisation of water for production uses and reuse of treated wastewater for landscaping, green areas and other uses. Ensure appropriate environmental flows in water bodies, establish and maintain a water demand management system, promote integrated land and water management and enforce riverbanks protection zones. Increase preparedness to severe climate events (flood / drought).
9	Stakeholder engagement and participatory IWRM	Stakeholder engagement mechanism developed and established at the WMZ/ Catchment level. Awareness raising on wise use of water resource and on waste management.
10	Technical Capacity Building	Training activities of Catchment/WMZ technical staff, organisations and stakeholder engagement at local/community

The prioritisation and sequencing of these interventions is detailed in the implementation plan and the overall Programmes' CMP costs (thousands US dollars) are indicated in below.

Programme		2017-2020 US\$ '000	2020-2025 US\$ '000	2025-2040 US\$ '000	Total cost US\$ '000
Programme 1:	Geo-database and GIS	228	14	43	285
Programme 2:	Information Management System on Water Resources (WR)	448	28	84	560
Programme 3:	Water Resources Monitoring	4,976	311	933	6,220
Programme 4:	Water Resources Knowledge Base	3,029	189	568	3,786
Programme 5:	Water Resources Planning and Regulation System	1,007	63	189	1,259
Programme 6:	Water Sector Infrastructure and Facilities	61,416	374,183	1,122,548	1,558,146
Programme 7:	Multipurpose Water Storage Facilities	1,608	19,695	59,084	80,387
Programme 8:	Integrated Water and Land Management	2,264	13,582	40,747	56,593
Programme 9:	Stakeholder Engagement and Participatory IWRM	35	207	622	863
Programme 10:	Technical Capacity Building	49	297	891	1,237

Programmes 6, geared to expanding the water supply infrastructures for full coverage of urban and rural population, increasing water storage capacity for domestic water supply in areas with seasonal deficits, rehabilitating and improve functionality of existing water for production storage facilities, developing groundwater storage for production in areas with water deficit, expanding irrigation schemes, improving sanitation and hygiene facilities and implement WWTP or alternative wastewater treatment method is seen to require much more than the rest followed by Programme 7. The plan, however, not be phased depending on availability of funds for implementation and as such may require update from time to time.

Pre-feasibility studies for the four multipurpose dams identified in the "Best scenario" have been conducted and are provided in a separate document. The pre-feasibility detail includes technical description of the infrastructure like dam height and length, level at crest, maximum and minimum operating level, impounded area and reservoir capacity. The infrastructure is also characterized by the population served (if water supply use is provided), gross irrigated and aquaculture area (if it supports irrigation), and installed capacity of hydropower project (if hydropower use is provided). Related costs for construction and operation and maintenance, but also benefits are estimated in order to conduct a financial evaluation and a multi-criteria analysis.

TABLE OF CONTENTS

FOREWORD	i
ACKNOWLEDGEMENTS	ii
EXECUTIVE SUMMARY	iii
LIST OF FIGURES	ix
LIST OF TABLES	x
ACRONYMS AND ABBREVIATIONS	xi
1 INTRODUCTION	1
1.1 BACKGROUND TO CATCHMENT PLANNING	1
1.2 OBJECTIVES AND PURPOSE OF THE CMP	2
1.3 REPORT STRUCTURE	2
2 APPROACH TO CATCHMENT MANAGEMENT PLANNING	3
3 LEGISLATIVE AND INSTITUTIONAL FRAMEWORK	5
3.1 POLICY AND LEGAL CONTEXT	5
3.2 THE CONSTITUTION OF THE REPUBLIC OF UGANDA (1995)	5
3.3 NATIONAL POLICIES	5
3.3.1 National Water Policy (1999)	5
3.3.2 National Policy for the Conservation and Management of Wetland Resources (1995)	6
3.3.3 Uganda National Land Policy	6
3.3.4 National Forestry Policy	6
3.3.5 The Renewable Energy Policy for Uganda	6
3.4 NATIONAL LEGISLATION	6
3.4.1 Water Act Cap 152 (1997)	6
3.4.2 National Environment Act (1995)	7
3.5 TRANSBOUNDARY CONSIDERATIONS	8
3.5.1 Legal Framework for the Sustainable Management of the Nile Waters:	8
3.5.2 Agreed Curve for the Lake Victoria Release:	8
3.5.3 Nile Basin Cooperative Framework Agreement	8
3.5.4 The Lake Victoria Basin Commission	8
3.6 INTERNATIONAL CONVENTIONS	8
3.6.1 Ramsar Convention (1971)	8
3.6.2 UN Framework Convention on Climate Change (UNFCCC) and related Kyoto Protocol	9
3.6.3 UN Convention on Biological Diversity	9
3.6.4 International conventions for shared water resources	9
3.7 THE INSTITUTIONAL SETUP	9
3.7.1 National Level	9
3.7.2 Regional Level	11
3.7.3 Catchment Level	11
3.7.4 Institutional Issues	14
4 STATUS OF THE CATCHMENT	15
4.1 CATCHMENT PHYSIOGRAPHY	15
4.1.1 Description	15
4.1.2 Sub-catchments	15
4.1.3 Land cover	17
4.1.4 Climate	18
4.1.5 Geology and Soils	18
4.2 WATER RESOURCES	18
4.2.1 River systems, lakes and wetlands	18
4.2.2 Climate Change	20
4.2.3 Water availability	20

4.2.4	Water Quality	23
4.2.5	Floods and Droughts.....	23
4.3	WATER DEMAND.....	24
4.3.1	Current water demand.....	24
4.3.2	Projected water demand	27
4.4	WATER BALANCE	27
4.5	SOCIAL AND ENVIRONMENTAL STATE.....	29
4.5.1	Population and demography	29
4.5.2	Social-economic profile.....	30
4.5.3	Poverty Status	31
4.5.4	Key Social issues and implications	31
4.6	STAKEHOLDERS.....	32
4.6.1	Stakeholders identified.....	32
4.6.2	Stakeholder Issues' mapping.....	33
5	VISION, OBJECTIVES, AND ANALYSIS OF OPTIONS	34
5.1	GUIDING PRINCIPLES	34
5.2	VISION AND STRATEGIC OBJECTIVES.....	34
5.2.1	Vision	34
5.2.2	Strategic Objectives	35
5.3	KEY CATCHMENT ISSUES.....	36
5.4	IDENTIFICATION OF OPPORTUNITIES AND OPTIONS	38
5.4.1	Potential opportunities.....	38
5.4.2	Potential Options.....	39
5.5	OPTIONS TO SCENARIOS	42
5.5.1	Scenario definition	42
5.5.2	Scenario comparison.....	48
5.5.2.1	Approach to Cost and Benefit Estimation.....	48
5.5.2.2	Multi-Criteria Analysis.....	48
5.5.2.3	Results and Final Considerations	51
6	MANAGEMENT AND INVESTMENT ACTIONS.....	55
6.1	GENERAL/COMMON INVESTMENT AND MANAGEMENT ACTIONS.....	56
6.2	SPECIFIC INVESTMENT AND MANAGEMENT ACTIONS.....	65
6.3	LOCATIONS OF WATER STORAGE INFRASTRUCTURE.....	69
6.4	PILOT AREAS FOR GROUNDWATER INVESTIGATION AND EXPLOITATION.....	70
7	IMPLEMENTATION PLAN AND FINANCING	71
7.1	IMPLEMENTATION PLAN.....	71
7.2	REQUIRED FINANCING.....	71
7.3	FINANCING SOURCES	73
7.3.1	Review of Financing Mechanisms	73
7.3.2	Main Financing Sources for CMP	73
7.3.3	Preliminary Strategy for Investment Interventions.....	74
7.4	PRE-FEASIBILITY STUDIES FOR MULTI-PURPOSE DAMS.....	75
	REFERENCES.....	76
	NATIONAL REFERENCE DOCUMENTS	76
	REFERENCE WEBSITES.....	76
	OTHER REFERENCES	76
	ANNEXES.....	77
	ANNEX 1 – ESTIMATION OF COSTS AND BENEFITS	77
	ANNEX 2 – IMPLEMENTATION PLAN	82

LIST OF FIGURES

Figure 1.1: Water Management Zones in Uganda	1
Figure 2.1: Overview of the catchment management planning process	3
Figure 3.1: Institutional Setup at a National Level (MWE, 2009)	10
Figure 3.2: Catchment Management Organisation Structure (DWRM 2016).....	12
Figure 3.3: An Overview of Uganda's Water and Environment Sector (MWE, 2009).....	13
Figure 4.1: The Aswa Catchment	15
Figure 4.2: Primary and Secondary sub-catchments for Aswa Catchment.....	16
Figure 4.3: Distribution of Land cover classes in Aswa	18
Figure 4.4: Land cover in Aswa Catchment	18
Figure 4.5: Mean Monthly Rainfall Pattern.....	19
Figure 4.6: Wetlands in the Aswa catchment	20
Figure 4.7: Historical flood events affecting the study area of the Aswa river (September-October 2007- Map compiled by WFP Emergency Preparedness and Response Branch [ODAP])	23
Figure 5.1: Categories and symbols of issues divided into strategic areas	37
Figure 5.2: Matrix of Criticality of Issues in the Catchment.....	38
Figure 5.3: Opportunities within the catchment	39
Figure 5.4: Map of MEMD sites for hydropower production foreseen in all scenarios of Aswa catchm.....	43
Figure 5.5: Map with main infrastructures of scenario A of Aswa Catchment	44
Figure 5.6: Map with main infrastructures of Scenario B of the Aswa Catchment	46
Figure 5.7: Map with main infrastructures of Scenario C of the Aswa Catchment.....	47
Figure 6.1: Map of potential sites for water storage implementation	69
Figure 6.2: Potential for groundwater exploitation for Aswa sub-catchments	70

LIST OF TABLES

Table 3.1: Institutional issues and implications	14
Table 4.1: Primary and secondary sub-catchments in the Aswa Catchment	16
Table 4.2: Surface Water Availability and Groundwater Recharge	20
Table 4.3: Sub-Catchment water availability	21
Table 4.4: Variation of Groundwater Recharge from the Current Scenario	22
Table 4.5: Current Gross water demand	25
Table 4.6: Current net water demand	26
Table 4.7: Water Balance for the Mean and Drought Hydrological Years	27
Table 4.8: Water Balance for the Mean Hydrological Year under climate Change Projections for 2030 and 2040 ...	28
Table 4.9: Comparison of water demand and availability	28
Table 4.10: Summary of Demographic Characteristics of the Aswa Nile districts	30
Table 4.11: Key Social Issue and Implications	31
Table 4.12: Stakeholders Engaged.....	32
Table 5.1: Strategic Objectives	35
Table 5.2: Water Governance Issues	36
Table 5.3: Potential Options identified for availability and access to water resources	40
Table 5.4: Potential Options identified for environmental and social sustainability and resilience	41
Table 5.5: Potential Options identified for water governance.....	42
Table 5.6: Benefits obtained in Scenario A.....	45
Table 5.7: Benefits obtained in Scenario B.....	46
Table 5.8: Benefits obtained in Scenario C.....	48
Table 5.9: NB-DSS indicators used for scenario evaluation.....	49
Table 5.10: Criteria weighting used for scenario evaluation	50
Table 5.11: Net volume of water storage for different scenarios.....	51
Table 5.12: Benefits for the different scenarios.....	51
Table 5.13: Capital Cost (Million US dollars) estimation for each scenario for the Aswa catchment	52
Table 5.14: Results Benefit Cost ratio (Million US dollars) of each scenario for the Aswa Catchment.....	52
Table 5.15: Indicator values calculated for the scenarios of the Aswa Catchment	53
Table 5.16: Scenario score and ranks assessment from different factors.....	54
Table 6.1: Common Investment and Management actions	56
Table 6.2: Specific Investment and Management Actions	66
Table 6.3: Locations of Water Storage Infrastructure.....	69
Table 7.1: Overall Programmes' and sub-programmes' CMP costs (thousands US Dollars).....	71
Table 7.2: Overall Programmes' and sub-programmes' CMP costs (millions shillings).....	72
Table 7.3: Multi-Criteria Analysis score and costs (Million US Dollars) of multipurpose dams	75
Table 7.4: High priority multipurpose storage projects with relative achievable development objectives.....	75

ACRONYMS AND ABBREVIATIONS

ACF	Action Contre le Faim (Action Against Hunger)
ACTED	Agency for Technical Cooperation and Development
ARC2	African Rainfall Climatology model version 2
asl	Above Sea Level
ASM	Artisanal and small-scale mining
AWMZ	Albert Water Management Zone
BOD	Biochemical oxygen demand
CAO	Chief Administrative Officer
CBO	Community Based Organization
CBWRM	Catchment Based Water Resources Management
CCU	Climate Change Unit
CFM	Collaborative Forest Management
CIS	Community Information System
cm	Centimetre
CMC	Catchment Management Committee
CMO	Catchment Management Organisation
CMP	Catchment Management Plan
CMS	Catchment Management Secretariat
CSF	Catchment Stakeholder Forum
CSO	Civil Society Organisation
CTC	Catchment Technical Committee
DCDO	District Community Development Office
DDP	District Development Plan
DEA	Directorate of Environmental Affairs
DEC	District Environment Committee
DESS	Department of Environmental Support Services
DFO	District Forestry Office
DHD	District Health Department
DIO	District Information Officer
DOM	Department of Meteorology
DPO	District Production Officer
DPs	Development Partners
DPU	District Planning Unit
DWD	Directorate of Water Development
DWO	District Water Officer
DWRM	Directorate of Water Resources Management
DWSSC	District Water and Sanitation Coordination Committee
ENRM	Environmental Natural Resources Management
FAO	Food and Agriculture Organization of the United Nations
FDGs	Focus Group Discussion
FEWS	Flood Early Warning System
FIETS	Financial, Institutional, Environmental Technical and Social
FSSD	Forestry Sector Support Department
FY	Financial Year
GDP	Gross Domestic Product
GIS	Geo-Information System

GIZ	Deutsche Gesellschaft für Internationale Zusammenarbeit
GoU	Government of Uganda
ha	Hectare
IDA	International Development Association
IFIs	International Financial Institutions
IP	Implementation Plan
IUCN	International Union for Conservation of Nature
IWRM	Integrated Water Resources Management
JICA	Japan International Cooperation Agency
JPF	Joint Partnership Fund
JWESSP	Joint Water and Environment Sector Support Programme
KIDDP	Karamoja Integrated Disarmament and Development Programme
km ²	Square Kilometre
KUWS	Karamoja Umbrella of Water and Sanitation
KWMZ	Kyoga Water Management Zone
l	Litre
LC	Local Council
LCB	Local Capacity Builders
LED	Local Economic Development
LLG	Lower Local Government
LSM	Large-scale mining
LTU	Livestock Topical Unit
M&E	Monitoring and evaluation
MAAIF	Ministry of Agriculture Animal Industry and Fisheries
masl	Metres Above Sea Level
MCA	Multi-Criteria Analysis
MCM	Million Cubic Meter
MEMD	Ministry of Energy and Mineral Development
MLG	Ministry of Local Government
mm	Millimetre
Mm ³	Million cubic meters
MOFED	Ministry of Finance, Planning and Economic Development
MOH	Ministry of Health
MoU	Memorandum of Understanding
Mt	Metric ton
MTI	Ministry of Tourism and Industry
MTTI	Ministry of Tourism, Trade and Industry
MW	Mega Watt
MWE	Ministry of Water and Environment
MWT	Ministry of Works and Transport
n.a.	not applicable
NAADS	National Agricultural Advisory Services
NaFORRI	National Forestry Resources Research Institute
NDPs	National Development Programs
NELSAP	Nile Equatorial Lakes Subsidiary Action Program
NEMA	National Environmental Management Authority
NFA	National Forest Authority

NGO	Non-Governmental Organization
NPA	National Planning Authority
NRDs	Natural Resources Departments
NRM	Natural Resources Management
NUSAF	Northern Uganda Social Action Fund
NWRA	National Water Resources Assessment
NWSC	National Water and Sewerage Corporation
O&M	Operation & Maintenance
OPM	Office of the Prime Minister
PME	Planning, Monitoring and Evaluation
PPPs	Public Private Partnerships
RDCs	Resident District Commissioners
RWTSUs	Regional Wetlands Technical Support Units
SBS	Sector Budget Support
SCMC	Sub-catchment Management Committee
SME	Small and Medium Enterprises
SNV	Netherlands Development Organisation
SSEA	Strategic Social and Environmental Assessment
SWAT	Soil and Water Assessment Tool
SWOT	Strength, Weaknesses, Opportunities and Threats
TLU	tropical livestock units
TSU	Technical Support Unit
UBOS	Uganda Bureau of Statistics
UGX	Ugandan Shilling
UNMA	Uganda National Meteorological Authority
UNRA	Uganda National Roads Authority
UNWMZ	Upper Nile Water Management Zone
UOs	Umbrella Organisation
UWA	Ugandan Wildlife Authority
UWASNET	Uganda Water and Sanitation NGO Network
UWS-E	Umbrella of Water and Sanitation East
VSLA	Village Saving and Loan Association
VWMZ	Victoria Water Management Zone
WASH	Water, Sanitation and Hygiene
WESWG	Water and Environment Sector Working Group
WfP	Water for Production
WMD	Wetlands Management Department
WMZ	Water Management Zone
WQ	Water Quality
WRA	Water Resources Assessment
WRDM	Water Resources Development and Management
WSDF-E	Water Sector Development Facility East
WSS	Water Supply Scheme
WSSBs	Water Supply and Sanitation Boards
WUC	Water Users Committee
WWTPs	Waste Water Treatment Plants
yr	Year

1.1 Background to Catchment Planning

The national water policy in Uganda is based on the Integrated Water Resource Management (IWRM) approach with implementation at the catchment level and provides an overall policy framework and defines the Government's policy objective as:

"To manage and develop the water resources of Uganda in an integrated and sustainable manner, so as to secure and provide water of adequate quantity and quality for all social and economic needs of the present and future generations and with the full participation of all stakeholders."

As part of the realisation of this objective, the National Water Policy has been based on the implementation of objectives for water management within the Integrated Water Resources Management (IWRM) framework. The IWRM in a river-basin context is defined as "a process that enables the coordinated management of water, land and related resources within the limits of a basin so as to optimise and equitably share the resulting socio-economic well-being without compromising the long term health of vital ecosystems."

A key feature of the implementation of IWRM in Uganda by the Ministry of Water and Environment (MWE) through the Directorate of Water Resources Management (DWRM) was to provide for the de-concentrated management of water resources to the local catchment level with the participation of all stakeholders.

Following the recommendations of the National Water Policy, the Water Sector Reform Study (2005), the JSR (2006) and other national and regional policies as well as steps already taken for implementation purposes, the country was delineated into four Water Management Zones (WMZs) along hydrological boundaries.

Thus, the northern parts of the country are covered by the Upper Nile Water Management Zone (UNWMZ), the western parts by the Albert Water Management Zone (AWMZ), the south by the Victoria Water Management Zone (VWMZ), and the east by the Kyoga Water Management Zone (KWMZ) as Figure 1.1 shows.

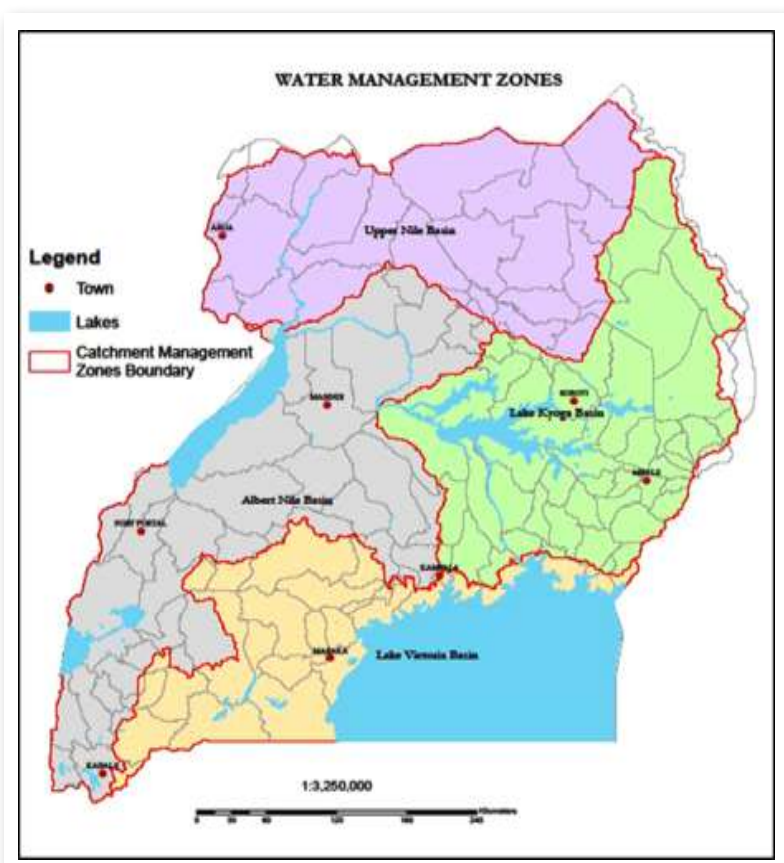

Figure 1.1: Water Management Zones in Uganda

Within each WMZ, there exists a number of smaller hydrological units called catchments for which tools and capacity for management of water resources have to be developed. Catchment Management Plans (CMPs) are to be developed for respective catchments in the WMZs to enable planning of water resources development and management at a catchment level.

In line with this, a Catchment Management Plan for Aswa, presented in this report, has been developed to mainly identify infrastructure investments and water management interventions and actions for sustainable management of the catchment. The Aswa Catchment, which is part of the Upper Nile WMZ drains an area of 27,677km², covering 15 districts of Abim, Agago, Alebtong, Amuria, Amuru, Gulu, Kaabong, Kitgum, Kole, Kotido, Lamwo, Lira, Otuke, Oyam, and Pader in part or whole. The preparation of this CMP is in line with the Catchment Management Planning Guidelines (MWE, 2014).

1.2 Objectives and Purpose of the CMP

The purpose of this CMP is to provide a number of agreed investments in infrastructure and other interventions and actions meant to help resolve conflict, conserve and protect the catchment and its natural resources, and ensure equitable access to and use of water resources.

Following the guidelines for catchment management planning in Uganda, the CMP also purposes to:

- Assess all catchment conditions and characteristics (physical, social, economic, environmental, political, trans-boundary etc.) in an integrated manner
- Raise awareness on the understanding and importance of as well as the responsibility for water resources management and environmental conservation among all stakeholders and how this will be of benefit to the sustainable economic growth and livelihoods in the catchment as a learning process
- Clarify the interdependence of all activities in the catchment and even the effects on neighbouring catchments
- Engage the stakeholders at all levels in the integrated planning process and help them decide on the best options and scenarios for the development of their catchment as well as in the development and implementation processes
- Motivate the stakeholders and put them into the position to play an active role in preserving their water resources and the environment
- Present the potential financing for the fully costed prioritised and sequenced investments, as well as a preliminary strategy for sourcing financing.

1.3 Report Structure

This report mainly has six chapters prepared to ensure logical and consistent flow of information throughout the document as highlighted here below:

- Chapter 1:** Introduction. This chapter presents the background to catchment management planning in Uganda, objectives of the CMP, and general layout of the report.
- Chapter 2:** Approach to catchment management planning. This chapter describes the general approach to catchment management planning in Uganda which is in line with the catchment management planning guidelines.
- Chapter 3:** Legislative and Institutional Framework. The existing policy, legal, and institutional arrangements, their linkages with catchment management planning and implementation, as well as the existing gaps are presented in this chapter.
- Chapter 4:** Status of the Catchment. This chapter discusses the main characteristics and features of the catchment which ultimately leads to identification of the major social, environmental, and water resources assessment issues together with the stakeholder engagement and issues' mapping.
- Chapter 5:** Vision, Objectives, and Analysis of Options. Catchment visioning and strategic analysis is presented and discussed in this chapter. The prioritisation of issues identified within the catchment, analysis of the options to manage the identified issues, as well as configuration of scenario and their evaluation.
- Chapter 6:** Management and Investment Actions. This chapter presents an agreed set of interventions resulting from the options for the best ranked scenario.
- Chapter 7:** Implementation Plan and Financing. This chapter presents the prioritised and sequenced development and management actions together with their costing.

2 APPROACH TO CATCHMENT MANAGEMENT PLANNING

The development of this CMP was solely based on the guidelines for Uganda’s Catchment-based Water Resources Planning(MWE, 2014). The process stipulated in these guidelines provides for various steps including development of a knowledge base, water resources planning analysis, stakeholders’ participation, and social and environmental context as indicated in Figure 2 1.From these thematic assessments, major issues/challenges within the catchment, the available opportunities, potential threats and risks are identified, options for managing the identified issues also identified, and this forms the basis for strategic analysis in order to meet the catchment vision and objective.A set of agreed interventions are then mapped and an implementation plan laid, constituting of the associated timing and costs, to form the main body of a Catchment Management Plan and the Implementation Plan.

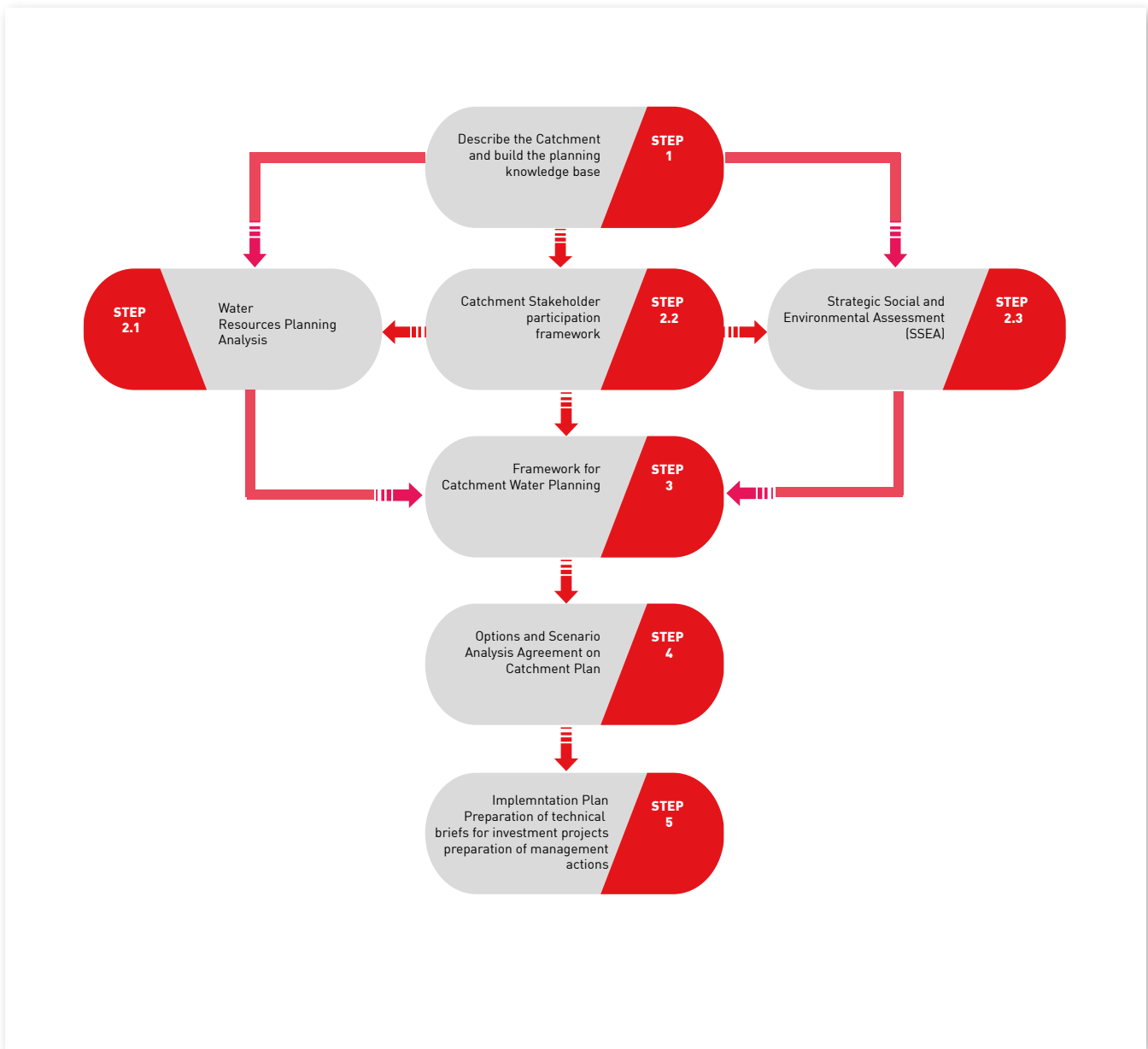

Figure 2.1: Overview of the catchment management planning process

The roadmap for the development of the Aswa CMP, therefore, sequentially included the following key processes, however, stakeholder consultation was done at almost all stages in the development process:

- Catchment Description and Building a Planning Knowledge Base, from which a wealth of information emanating from all available Policies, Strategies and Plans, Water Sector data and information on existing and planned water resources development and management, water infrastructure, institutional arrangements all of which will inform, influence, and drive sustainable catchment management and development
- Water Resource Planning Analysis, which presents an analysis of current and projected water availability, uses, and demand and related projections to 2030 and 2040 for three key sub-sectors; water for people, water for production and water for energy. Water for environment was evaluated considering low flow and dry season flow in order to estimate environmental flow
- Stakeholder Engagement, which highlights the stakeholder participation framework and interactions at all levels in the process of developing the CMP. Field visits, informal and formal meetings as well as the proceedings of joint stakeholder forum workshops were highlighted and their input of water resources issues captured
- Strategic Social and Environmental Assessment, which presents the identified social and environmental issues and were taken into account in the planning process to ensure their integrated into the plan and for which sound measures for social and environmental protection were proposed
- Framework of Catchment Water Planning sets the scene for options by identifying all the issues and conditions in the catchment related to water and natural resources that are likely to be a major influence, or present themselves as risks, needs or opportunities. These mainly come from the Strategic Social Environmental Assessment and the Water Resources Assessment
- The Options and Scenario Analysis provides an analysis of the options and the alternative sets of options that form scenarios. These scenarios are evaluated to get the best scenario which informs the investment and management interventions or agreed infrastructure investments and interventions within the catchment management plan.

The agreed infrastructure investments and management interventions were then costed, prioritised and sequenced thereby forming the main body of the CMP.



3.1 Policy and legal context

The Africa Water Vision 2025 states its goal as "an Africa where there is an equitable and sustainable use and management of water resources for poverty alleviation, socio-economic development, regional cooperation, and the environment" and the water policy reform initiative is aimed at realising this vision for water management in Uganda within the IWRM framework. Worth noting is the fact that sustainable management of water resources is not limited to physical management but also incorporates legislation, policies, economic tools, institutions, and stakeholders involved in management, regulation, and utilisation of water resources. Whilst water is essential to livelihoods, and always provides for subsistence and survival, it does not solely drive economic development. Many other factors also have to be in place if the provision of water is to have its full beneficial impact on society. A strong cooperative approach between role-players and especially governmental institutions is, therefore, essential to work together within their respective legislative and policy mandates to promote the approach to IWRM and to ensure the best economic, social and environmental development.

A synopsis of the legal context in Uganda under which IWRM will be implemented and managed is provided by:

- The Constitution of the Republic of Uganda
- National Policies
- National Legislation
- Trans-boundary considerations, and
- International Conventions

3.2 The Constitution of the Republic of Uganda (1995)

The Constitution of the Republic of Uganda sets a number of national guiding principles relating to, and supporting the principles of sustainable development including having balanced and equitable development, which requires that the State adopts an integrated and coordinated planning approach. It further stipulates that the State ensures balanced development between different areas of Uganda and between the rural and urban areas with special measures employed to favour of the development of the least developed areas.

Through the constitution, the State is entrusted to protect important natural resources including land, water, wetlands, minerals, oil, and fauna and flora on behalf of the people of Uganda. The state must further endeavour to fulfil the fundamental rights of all Ugandans to social justice and economic development, with all developmental efforts directed at ensuring the maximum social and cultural well-being of the people. In terms of the Constitution, all Ugandans have a right to education, health services, clean and safe water, work, decent shelter, adequate clothing, food security, and pension and retirement benefits.

The State must promote sustainable development and public awareness of the need to manage land, air, water resources, as well as use of natural resources, in a balanced and sustainable manner for the present and future generations. All possible measures must be taken to prevent or minimise damage to land, air, and water resources resulting from pollution or other causes. The Constitution entrusts the State to ensure the conservation of natural resources and promote the rational use of natural resources to safeguard and protect the biodiversity of Uganda. Through all this, the Constitution sets the scene for Integrated Water Resource Management in Uganda.

3.3 National Policies

3.3.1 National Water Policy (1999)

The 1999 National Water Policy provides an overall policy framework that defines the Government's policy objective as managing and developing water resources of Uganda in an integrated and sustainable manner, to secure and provide water of adequate quantity and quality for all social and economic needs sustainably, with the full participation of all stakeholders,"(Directorate of Water Resources Management, 2012).

According to the National Water Policy and the Water Act Cap 152, the responsibilities to provide water services and to maintain facilities were devolved to local councils in districts and urban centres. The role of the Central Government's Agencies is that of guiding and supporting as required. The Act thus emphasises the shared responsibilities in development and management of water resources among stakeholders, including the Private Sector and non-Government organisations (NGOs) to regulate human activities that can pose risks to water resources. It also provides for pollution control measures with associated penalties and fines.

The existing policy and legal framework promotes wise use of water resources from the lowest possible level, while considering roles to be played by different stakeholders at different levels. This offers an opportunity to ensure that communities can actively participate in the development and maintenance of water sources within a given catchment.

3.3.2 National Policy for the Conservation and Management of Wetland Resources (1995)

The national policy for the conservation and management of wetland resources (1995) is aimed at restricting the continued loss of wetlands and their associated resources and aims to ensure that benefits derived from wetlands are sustainably and equitably distributed to all people of Uganda. The wetlands policy calls for:

- No drainage of wetlands unless more important environmental management requirements supersede
- Sustainable use to ensure that benefits of wetlands are maintained for the foreseeable future
- Environmentally sound management of wetlands to ensure that other aspects of the environment are not adversely affected
- Equitable distribution of wetland benefits
- The application of Environmental Impact Assessment procedures on all activities to be carried out in a wetland to ensure that wetland development is well planned and managed.

Wetland related issues have been incorporated into the National Environmental Statute, 1995. The Wetlands Policy is strengthened by a supplementary law specifically addressing wetland concerns. Wetland resources are regarded as forming an integral part of the environment and it is recognised that present attitudes and perceptions of Ugandans regarding wetlands be changed. Wetland conservation requires a coordinated and cooperative approach involving all the concerned people and organisations in the country, including the local communities.

Within the context of the guiding principles, the National Wetlands Policy set five goals:

- To establish the principles by which wetland resources can be optimally used over time
- To end practices, which reduce wetland productivity
- To maintain the biological diversity of natural or semi-natural wetlands
- To maintain wetland functions and values
- To integrate wetland concerns into the planning and decision making of other sectors.

3.3.3 Uganda National Land Policy

The policy provides a framework for articulating the role of land in national development, land ownership, distribution, utilisation, alienability, management, and control of land. The Land Policy has a specific objective that seeks to ensure sustainable utilisation, protection and management of environmental, natural and cultural resources on land for national socio-economic development. It seeks to ensure that all land use practices and plans conform to principles of sound environmental management, including biodiversity, preservation, soil and water conservation, and sustainable land management. Section 6.7, item 140 promotes optimal and sustainable use and management of environment and natural resources for the present and future generations.

3.3.4 National Forestry Policy

It provides for the establishment, rehabilitation and conservation of watershed protection forests. It aims at promoting the rehabilitation and conservation of forests that protect the soil and water in Uganda's key watersheds and river systems.

4.3.5 The Renewable Energy Policy for Uganda

The overall goal of the Renewable Energy Policy is to increase the use of modern renewable energy, from the current 4% to 61% of the total energy consumption by the year 2017. Renewable sources of energy include solar energy, hydropower, biomass, wind, and geothermal as well as peat and wastes. For hydropower, the policy targets 1,200MW of installed capacity by 2017 for large hydropower plants and 85MW of installed capacity by 2017 for small and micro hydropower plants.

3.4 National legislation

3.4.1 Water Act Cap 152 (1997)

Uganda's Water Act Cap 152 provides for the use, protection, and management of water resources and supply; and facilitates the devolution of water supply and sewerage undertakings. Its objectives are:

- i) To promote the rational management and use of the water resources of Uganda by:
 - Use of appropriate standards and techniques for the investigation, use, control, protection, management and administration of water resources
 - Coordinating all public and private activities which may influence the quality, quantity, distribution, use or management of water resources
 - Coordinating, allocating and delegating responsibilities for the investigation, use, control, protection, management or administration of water resources
- ii) To promote the provision of a clean, safe and sufficient supply of water for domestic purposes
- iii) To ensure appropriate development and use of water resources other than for domestic use, e.g. watering of stock, irrigation and agriculture, industrial, commercial and mining uses, generation of energy, navigation, fishing, preservation of flora and fauna, and recreation in ways which minimise damage to the environment

iv) To control pollution and promote the safe storage, treatment, discharge and disposal of waste, which may pollute water or otherwise harm the environment and human health.

According to the National Water Policy (1999) and the Water Act Cap 152, the responsibilities to provide water services and to maintain facilities are devolved to local councils in districts and urban centres, with full mandates to construct, acquire or alter any water supply work. The role of the Central Government's Agencies is that of guiding and supporting as required. The Act thus emphasises the shared responsibilities in development and management of water resources among stakeholders (including the Private Sector and NGOs) to regulate human activities that can pose risks to water resources. It also provides for pollution control measures with associated penalties and fines.

Other Water Sector related policies form synergies with the Water Policy include:

- The National Gender Policy of 1999, which recognises women and children as the key stakeholders of water
- The Local Government Act of 1997, which underscores the role of Local Government in provision and management of water and sanitation, empowering the local authorities to plan and to implement development interventions according to local needs
- The 1998 Land Act, which stipulates the responsibility of the Central and Local Government in protecting environmentally sensitive areas such as natural lakes, rivers, groundwater, natural ponds, natural streams, wetlands, forest reserves, national parks and any other land reserved for ecological and tourist purposes
- The 1998 Water Abstraction and Wastewater Discharge Regulations for controlling water abstraction and wastewater discharge, to promote sustainable and environmentally friendly development and use of water resources. Some issues feature at the level of the policy and regulatory framework while others are crucial at catchment level. For instance, plans to develop irrigation schemes necessitate the development of a proper mechanism to protect water use rights and to settle disputes, especially between upstream and downstream water users. Issues of equity exist, whereby some users, often powerful up-stream users, put their interests first. In establishing the mechanism to handle user rights and conflict resolution, issues of active participation of all concerned stakeholders, including women, livestock keepers, and youths, should be taken into consideration.

The existing policy and legal framework promotes wise use of water resources from the lowest possible level, while considering roles to be played by different stakeholders at different levels. This offers an opportunity to ensure communities actively participate in development and maintenance of water sources.

3.4.2 National Environment Act (1995)

The National Environmental Act provides for "sustainable management of the environment; to establish an authority as a coordinating, monitoring, and supervisory body for that purpose; and for other matters incidental to or connected with the foregoing."

The Act makes provision for a tiered approach to environmental planning, commencing with a National Environmental Management Plan to be prepared and reviewed every five years. Each district is required to compile a district environmental action plan every three years that compliments the National Environmental Management Plan. Both of these plans are made available to the public. At a project scale, the Act stipulates that developments of a certain nature (as determined under Section 19(7) of the Act) are required to undertake detailed Environmental Impact Assessment (EIA) process in a prescribed manner.

The Act also makes provision for the monitoring of air and water quality and makes provision for the establishment and implementation of minimum standards pertaining to emissions and effluent.

Section 34 of the Act deals specifically with limitations in the use of rivers and lake systems and aims to minimise the negative impacts and control activities that have the potential to be detrimental to these systems. The Act goes on to make specific provisions for the protection of river banks and lake shores in Section 35 and protection and management of wetland systems in Section 36 and 37 respectively.

Hilly and mountainous areas have also been identified as areas requiring special attention and protection by the Act. The Act makes provision for the restoration of vegetative cover in these areas. This Act coupled with the provisions made in the Prohibition of the Burning of Grass Act (1974) and the Forest Act (1947) and the Cattle Grazing Act (1945) provides a good basis for restoration, protection and management of vegetative cover in hilly and mountainous areas.

3.5 Trans-boundary considerations

The trans-boundary nature of Uganda's water resources are such that there are a number of international conventions relating to management of water resources with which Uganda must comply. Currently, the key conventions/organisations to which Uganda is party are; the Protocol for Sustainable Development of Lake Victoria Basin and Nile Basin Initiative.

3.5.1 Legal Framework for the Sustainable Management of the Nile Waters

Treaties regarding the management of the waters of the Nile basin date back to 1929 when Great Britain and Egypt signed an agreement under which no irrigation, power works or other measures were to be constructed or undertaken on the Nile, and its branches, or on lakes from which it flows in the Sudan, or in countries under British administration except with the previous agreement of the Egyptian government. The Agreement was followed by the 1959 Agreement on the Full Utilisation of the Nile Waters, which was signed between Egypt and Sudan. The 1959 Agreement allocates the waters of the Nile between the two signatory states.

3.5.2 Agreed Curve for the Lake Victoria Release:

Before the construction of the Nalubale (Owen Falls) Dam, which began in 1951, the outflows from Lake Victoria were controlled naturally by the Ripon Falls some 3km upstream of the dam site. After study of the discharge measurements, which had been made since 1923 at Namasagali, about 80km downstream of the lake outfall, an Agreed Curve was established, which described the natural relation between lake levels measured at the Jinja gauge and simultaneous measured outflows from the lake. Since 1954 (when the Nalubale Dam was completed), water flow from the lake has been constrained to mimic the natural outflows from the lake using a rating "Agreed Curve" that correlates the flow of the Nile at the source with Lake Victoria water level.

3.5.3 Nile Basin Cooperative Framework Agreement

The Nile Basin countries embarked on the process of negotiating and developing a new agreement for the sustainable management and development of the shared Nile water resources in the 1990s. This process is still on-going and it is envisaged that once these negotiations are successfully concluded, the resulting agreement will supersede all the existing Nile water agreements (NELSAP, 2012).

3.5.4 The Lake Victoria Basin Commission

The Lake Victoria Basin Commission, which was established under article 33 of the "Protocol for Sustainable Development of Lake Victoria Basin" has a broad function of promoting, facilitating and coordinating activities of different actors towards sustainable development and poverty eradication of the Lake Victoria Basin. These activities include catchment management interventions among others.

3.6 International Conventions

3.6.1 Ramsar Convention (1971)

The Convention on Wetlands (Ramsar, Iran, 1971) is an intergovernmental treaty that commits member countries to maintain the ecological character of Wetlands of International Importance and to plan for the "wise use", or sustainable use, of all of the wetlands in their territories. The Convention's mission is "the conservation and wise use of all wetlands through local and national actions and international cooperation, as a contribution towards achieving sustainable development throughout the world. "The wise use of wetlands is defined as "the maintenance of their ecological character, achieved through the implementation of ecosystem approaches, within the context of sustainable development." Uganda signed the Convention on the 4th July 1988. It currently has 12 Ramsar registered wetland systems, representing a combined area of 454,303ha.

3.6.2 UN Framework Convention on Climate Change (UNFCCC) and related Kyoto Protocol

Uganda ratified the UNFCCC in 1993 and is one of the Least Developed Countries (LDCs). The First National Communication to the UNFCCC was developed in 2002. A Climate Change Policy was launched in 2012, with a related prioritisation of outputs under a short (1-5 years), medium (6-10 years) and long-term (10-15 years) timeframes. The priorities in the National Climate Change Policy have been integrated in the Second National Development Plan (NDP II) 2015/16 – 2019/2020.

3.6.3 UN Convention on Biological Diversity

The Convention's main objective is to ensure the conservation of biological diversity and sustainable use of its components. The study process should undertake thorough investigation of the sites and come up with lists of biodiversity in the areas and available information indicate that none of the groups are threatened, rare or vulnerable, hence no impact of the project on such groups.

3.6.4 International conventions for shared water resources

There are a number of international conventions relating to management of shared water resources with which Uganda must comply. Currently, the key conventions/organisations to which Uganda is party are; the Protocol for Sustainable Development of Lake Victoria Basin and Nile Basin Initiative referred to in section 3.5.3 above.

3.7 Institutional setup

3.7.1 National Level

The Ministry of Water and Environment (MWE) plans and coordinates all water and environmental sector activities and is the ultimate authority responsible for water resources and environmental management in Uganda. The MWE has the overall responsibility for setting national policies and standards related to water and the environment, managing and regulating all water resources and determining priorities for water development and management. The MWE is divided into three directorates: Directorate of Water Resource Management (DWRM), the Directorate of Water Development (DWD), and the Directorate of Environmental Affairs (DEA).

The DWD has the responsibility for providing overall technical oversight for the planning, implementation, and supervision of the delivery of urban and rural water and sanitation services across the country including water for production. It is responsible for regulating the provision of water supply and sanitation and the provision of capacity development and other support services to Local Governments, Private Operators and other service providers. The Directorate comprises of three Departments: Rural Water Supply and Sanitation, Urban Water Supply and Sanitation, and Water for Production.

The DEA is responsible for environmental policy, regulation, coordination, inspection, supervision and monitoring of the environment and natural resources as well as the restoration of degraded ecosystems and mitigating and adapting to climate change. The DEA comprises of four departments of Environmental Support Services (DESS), Forestry Sector Support Department (FSSD), Wetlands Management (WMD), and the Department of Meteorology (DOM), recently turned into an Authority.

The MWE further works closely with the National Environment Management Authority (NEMA), which is mandated with the coordination, monitoring, regulation, and supervision of environmental management; the National Water and Sewerage Corporation (NWSC) — with the mandate to operate and provide water and sewerage services in the larger urban centers; and the National Forest Authority (NFA), whose mandate is to manage Central Forest Reserves and to supply high quality forestry-related products and services (see Figure 3 1).

Other national entities significantly impacted by technical water management issues are the Ministry of Agriculture, Animal Industry and Fisheries (MAAIF); the Ministry of Tourism and Industry (MTI); and the Ministry of Energy and Mineral Development (MEMD). The Ministry of Education and Sports (MES) is responsible for the implementation of Water and Sanitation in schools, and the Ministry of Health (MOH) is responsible for sanitation via the environmental health department.

The Ministry of Local Government (MLG) oversees the implementation of Local Government Development Plans, which include water supply and programmes for the improvement of hygiene and sanitation in institutions and public places. There are a number of development partners, private sector, and NGOs that also act in the water

sector providing services, advice, and facilitation. A number of NGOs active in the water sector are coordinated at the national level through the Uganda Water and Sanitation NGO Network (UWASNET), an umbrella organisation largely funded by development partners and the MWE. An outline of organisations directly or indirectly involved in water management is indicated in Figure 3.3.

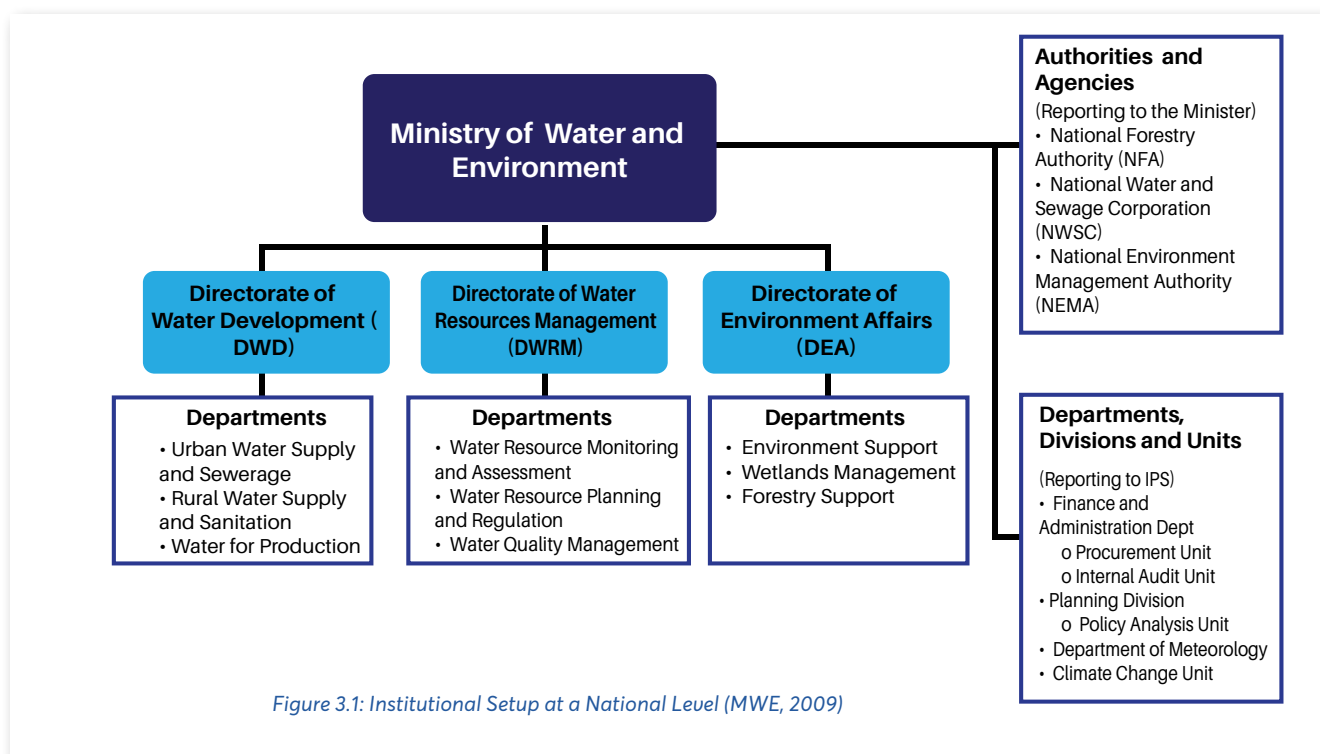

Coordination is a key process for Integrated Water Resources Management (IWRM), which involves multiple stakeholders from different sectors, on different scales, and with different structures and interests. At the national level, the following committees are relevant to integrated water resources management:

- The Policy Committee on Environment: chaired by the Prime Minister, at the highest level of political decision-making
- The Water Policy Committee, which is composed of directors, and enables high-level and strategic dialogue specifically in the water sector
- The IWRM Working group, which is an informal working group enabling technicians to coordinate
- The Water and Environment Sector Working Group (WESWG)
- The Inter-Ministerial Technical Committee regarding Water for Production, comprising members from the MWE, Ministry of Agriculture, Animal Industry and Fisheries (MAAIF), Office of the Prime Minister, National Planning Authority, and Ministry of Finance. It meets on a quarterly basis to coordinate investments and works regarding water for production
- The Wetlands Advisory Group (WAG), which is a technical group dedicated to wetlands. The WAG improves coordination on wetlands issues, particularly on the issue of dry land rice
- The MWE-DWRM has created Water Net, a network for building capacities of stakeholders connected to the water sector.

The National Environment Management Authority (NEMA) is the apex body for environmental law enforcement in Uganda. However, several functions have been delegated to other institutions as lead agencies in their respective fields. NEMA is in charge of:

- Review and administrative clearance of environmental evaluations, in conjunction with other lead agencies
- Delivery of permits (for instance, permits for activities within the legal buffer zones of water bodies). The responsibility of delivering permits is vested into the different lead institutions
- Monitoring compliance. The responsibility of control is distributed over 375 gazetted inspectors (2014) distributed in many Ugandan institutions (including the MWE). Only 30 of them belong to NEMA.

An Environmental Police has been formed at NEMA, comprising 25 officers. Only five regional Environmental Police officers (liaison officers) have been designated, among which one is based in Mbale (for the eastern region: his area covers 52 districts corresponding to a quarter of the country) and one in Jinja (for the south-eastern region). The liaison officers belong to the regular police but are specifically trained in environmental issues. They are under the command of the territorial police (Regional Police Commander/District Police Commander). Their functions include sensitisation, demarcation, control, issuing warnings, following up of cases, eviction, and prosecution. Within each district, there are offices that are in charge of the environment, forestry, wetlands, agriculture, fisheries, planning among others. However, the structure varies from district to district.

3.7.2 Regional Level

As a result of the deconcentration of the management of water resources, DWRM created four Water Management Zones (WMZ) following hydrological boundaries. They operate on regional level with the objective of bringing the central services closer to the stakeholders. Their primary role is to facilitate sustainable development of the water resources for the economic and social benefit of the people in the catchment and to implement the water management measures needed to protect and conserve the catchment and its water resources, ensure sustainability and reduce or resolve conflicts over resource use.

The DWD established the Water and Sanitation Development Facility (WSDF) as a mechanism for supporting water supply and sanitation facilities for rural growth centres and small towns, intended to promote a demand-responsive approach where Water Authorities/Town Councils or Town Boards apply for funding. The successful applicant is assisted by the WSDF to develop piped water supply systems.

Technical Support Units (TSU) established by DWD at the regional level have the mandate to support capacity building of district-based structures. This involves training, technical advice and support supervision of districts to enable them to effectively implement their roles in the rural sub-sector. The mandate also covers water for production.

Umbrella Organisations (UO) are also regional organisations constituted as associations of the local Water Supply and Sanitation Boards (WSSB) with the principal objective of providing operation and maintenance (O&M) back-up support (training, technical, legal and organisational support, supervision of rehabilitation and extension works as well as water quality monitoring).

The DWD has further deployed staff from its Department of Water for Production to the regions while DEA has also established offices for its Wetlands Department on regional level.

These deconcentrated units in the regions are based together for improved cooperation and integration and represent the MWE on regional level.

3.7.3 Catchment Level

During the catchment management planning process, an institutional framework has to be created, which brings the stakeholders together to present and exchange their views and thus give the process legitimacy. Hence, the WMZ establishes Catchment Management Organisations (CMOs), which builds on and utilises to the maximum practicable extent existing structures and relationships. The CMOs consists of several bodies Figure 3 2:

The Catchment Stakeholder Forum (CSF) brings together all actors on catchment management. The CSF defines key issues related to water resources in the catchment that require consideration in order to effectively protect, manage, and develop water resources. It provides input to the CMP for coordinated, integrated and sustainable development and management of water and related resources in the catchment, including their implementation status

The Catchment Management Committee (CMC) is composed of representatives of all relevant stakeholder groups (government, politicians, and community based organisations, NGOs, water users, media, academic institutions, and private sector) and collaborates with the WMZ during the formulation of a Catchment Management Plan and plays a steering role during its implementation. The CMC responsibilities include: coordination of stakeholder-driven definition of key issues related to water resources, promotion of coordinated planning, and implementation as well as stakeholder-driven decision making related to integrated and sustainable development and management of water and related resources, development of plans for coordinated, integrated and sustainable development and management of water and related resources. It endorses the CMP and presents it to the Catchment Stakeholder Forum for information purposes. The CMC acts as an Executive Board for the Catchment Management Organisation.

The Catchment Management Secretariat (CMS) provides support to the Catchment Management Committee in coordinating the planning and implementation of activities in the catchment as well as following up of recommended actions by the stakeholders. The CMS acts as an administrative secretariat for the Catchment Management Committee as well as the Catchment Technical Committee.

The Catchment Technical Committee (CTC) forms the technical arm of the CMO and supports the CMC in their tasks. The CTC brings technical expertise and knowledge during the formulation of the Catchment Management Plan, operationalises and sometimes implements programmes and projects from the plan, and generally ensures that the different districts collaborate to implement the plan. It comprises of technical people from government, NGOs, private sector, development agencies, and other relevant organisations in the catchment.

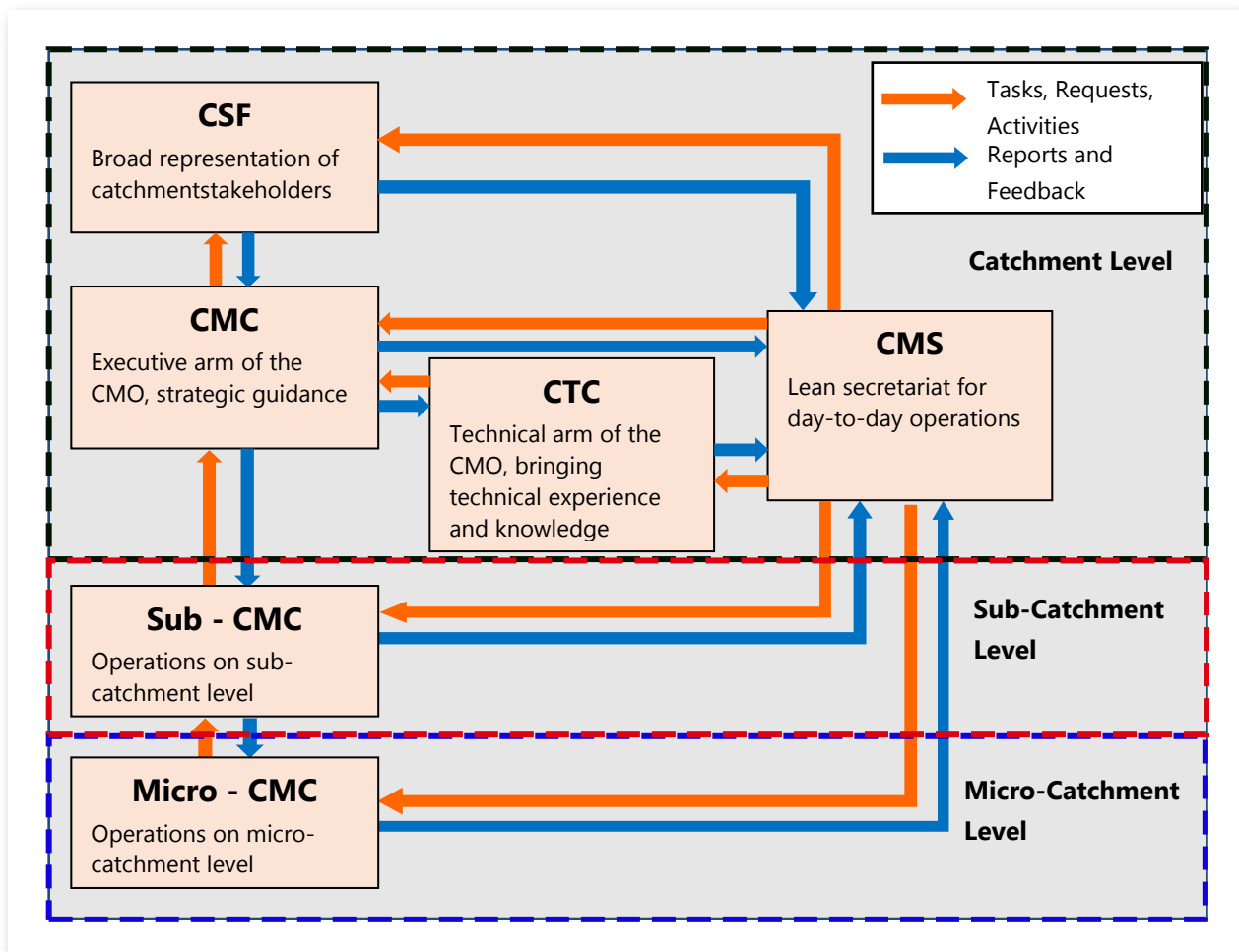

Figure 3.2: Catchment Management Organisation Structure (DWRM 2016)

Other relevant institutions on the catchment level are:

At the District Level, the District Natural Resources Department (including the District Environment Office, District Forestry Office, and District Wetlands Office), District Works or Engineering Department under which the District Water Office falls, District Production Department with the District Agricultural Office, District Veterinary Office, and District Fisheries Office, District Planning Department, Department of Community Based Services, District Information Department, and District Health Department are key in the implementation of the CMP. However, the structure varies from district to district according to the natural conditions in the district

Policies at national level are translated into Sector Development Plans, which are implemented at district level under the Decentralisation Policy. Most districts have 5-year district development plans in which all sector plans are integrated. Natural Resources Management activities are mandated to be implemented by every district, Sub-counties, CBOs and CSOs, Water User Associations etc.

Additionally, there are a number of private sector and NGOs, which also act in the water sector, providing services, advice, and facilitation. They work on catchment and regional level or sometimes combine the two. Many of these NGOs are coordinated at the national level through the Uganda Water and Sanitation NGO Network (UWASNET), an umbrella organisation largely funded by development partners and the MWE.

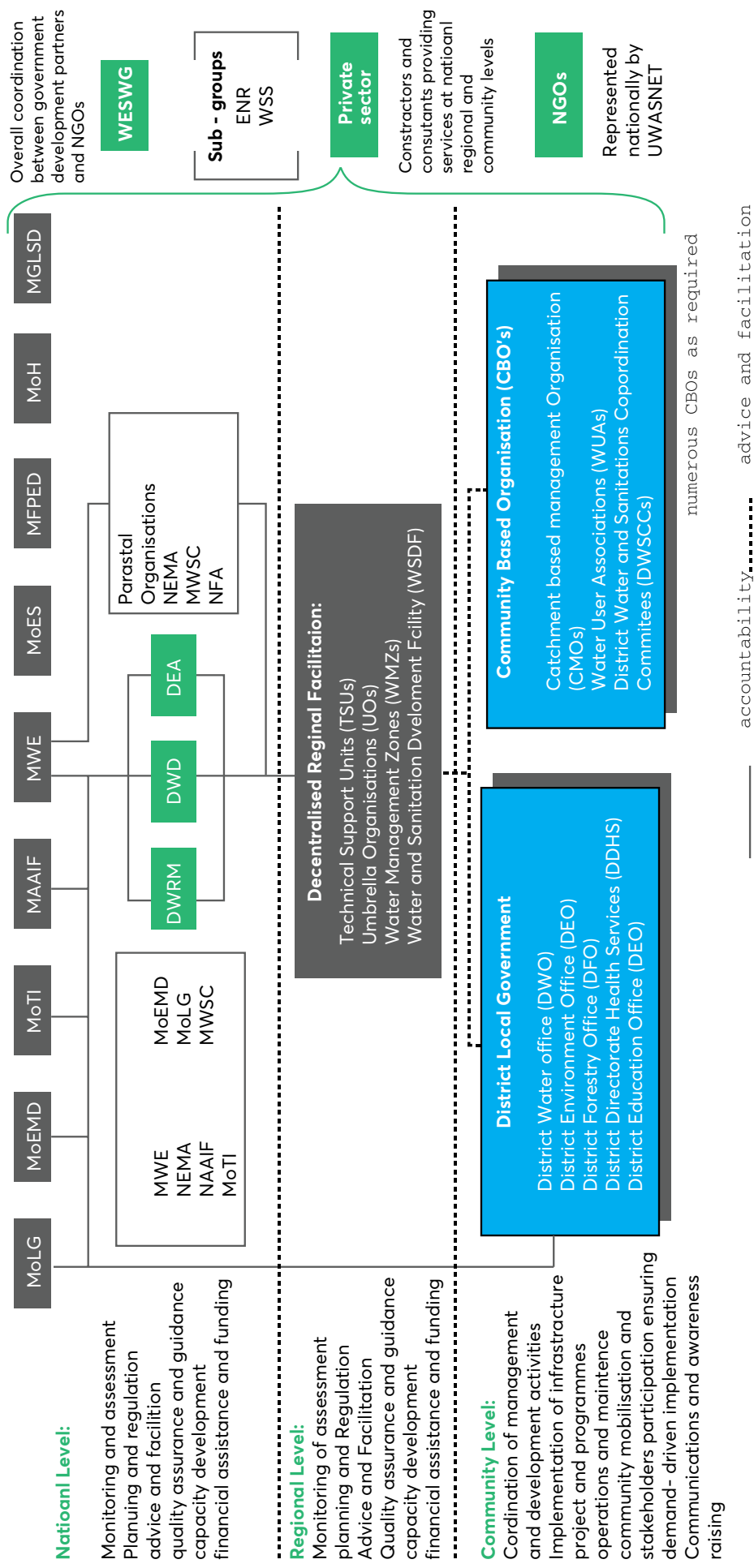

Figure 3.3: An Overview of Uganda's Water and Environment Sector (MWE, 2009)

3.7.4 Institutional Issues

Water resources management in Uganda continues to face some institutional challenges, mainly related with technical capacity, coordination, and enforcement of rules. Table 3.1 highlights some of these challenges. Table 3.1: Institutional issues and implications

Table 3.1: Institutional issues and implications

Issues	Background and Implications
Technical Capacity in local authorities	Limited capacity in institutions on local level with limited knowledge base. This has an impact on development and service delivery.
Coordination and cooperation between institutions	Development initiatives by respective institutions are planned independently. Lack of coordination leads to inefficient use of water resources and lack of resource protection.
New institutional framework in water management	CMOs are being established. More direct interaction on local level with institutions will create more awareness and integration. Required capacities are being transferred to the zones.
Water user participation	Formal stakeholder forums are not established yet. Some water sector committees such as water and sanitation advocacy committees need to be expanded. Water sector user groups lack capacity and information on good management practices.
Law enforcement	Limited capacity and political will to enforce legislation leads to degradation of natural resources.
Development of Catchment Management Plans	It is vital that CMPs are implemented to achieve sustainability. All parties need to reach agreement on actual accountability, actual monitoring and actual enforcement as it is here where success or failure of initiatives will be determined.



4.1 Catchment Physiography

4.1.1 Description

River Aswa is a major river in north-eastern Uganda, which flows northwest into South Sudan and joins the White Nile. The river originates in hills in the north-western part of Katakwi District and flows through Lira District and becomes the border between Pader and Gulu districts where its' two main tributaries, River Agago and then the River Pager flow into it. River Aswa forms most of the border between Atiak and Kitgum before crossing into South Sudan east of the border town of Nimule and joining the White Nile about 10 miles northwest of Nimule.

The Aswa Catchment drains an area of 27,677 square kilometres covering 15 districts of Abim, Agago, Alebtong, Amuria, Amuru, Gulu, Kaabong, Kitgum, Kole, Kotido, Lamwo, Lira, Otuke, Oyam, and Paderin part or whole.

The estimated population of all the 15 districts covered by the Aswa Catchment, based on the provisional results of the 2014 Population and Housing Census, is 3,292,176 (UBOS, 2014), and using the available spatial and statistical data, 55.45% (1,825,667 people) of these live within the catchment.

Gulu and Lira are the most populated districts in the Aswa Catchment while Agago, Alebtong, Oyam, and Kole have medium-low population and the other districts have very low population density.

4.1.2 Sub-catchments

The Aswa Catchment was delineated into eight primary sub-catchments and 17 secondary sub-catchments as shown in Figure 4.2. These primary and secondary sub-catchments are shared among various districts; therefore the management plan and criteria for allocation of water resources to different areas and uses shall follow a shared and coordinated approach.

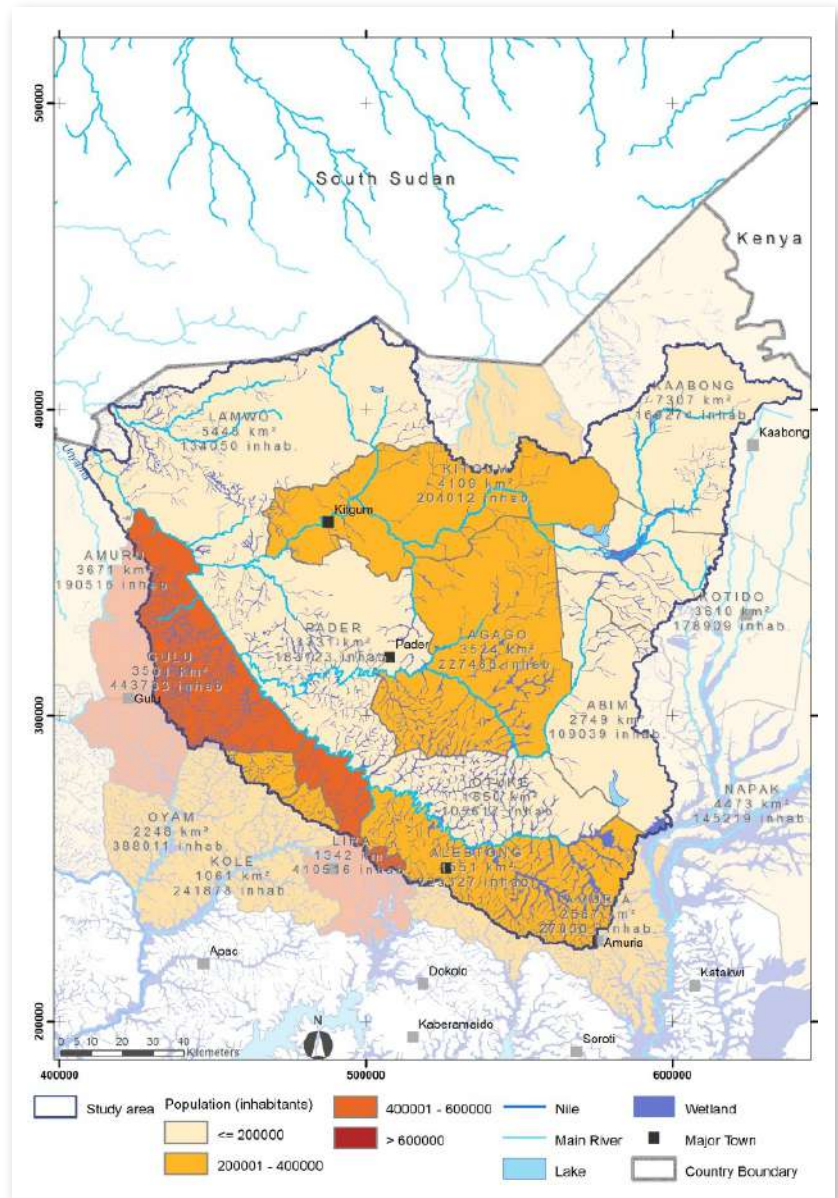

Figure 4.1: The Aswa Catchment

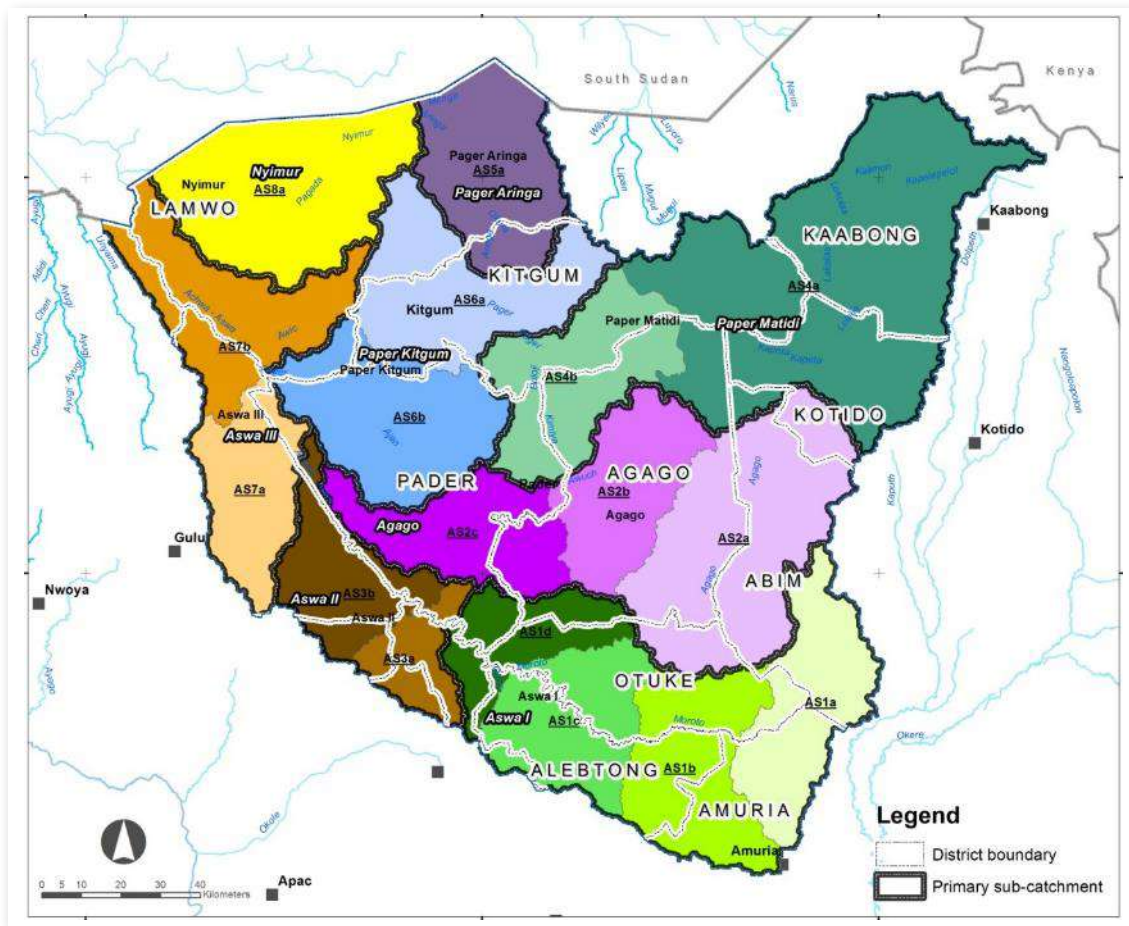

Figure 4.2: Primary and secondary sub-catchments for the Aswa Catchment

Table 4.1: Primary and secondary sub-catchments in the Aswa Catchment

Catchment	Primary Sub Catchment	Code Primary	Code Secondary	Main river
Aswa	Aswa I	AS1	AS1a	Aswa (upper reach, up to Aswa I)
		AS1	AS1b	
		AS1	AS1c	
		AS1	AS1d	
Agago	AS2	AS2	AS2a	Agago
		AS2	AS2b	
		AS2	AS2c	
Aswa II	AS3	AS3	AS3a	Aswa (middle reach, from Aswa I to Aswa II)
		AS3	AS3b	
Pager Matidi	AS4	AS4	AS4a	Pager (upper reach, before Aringa's confluence)
		AS4	AS4b	
Pager Aringa	AS5	AS5a	Aringa	
Pager Kitgum	AS6	AS6	AS6a	Pager (lower reach, after Aringa's confluence)
		AS6	AS6b	
Aswa III	AS7	AS7	AS7a	Aswa (lower reach, from Aswa II to Uganda's border)
		AS7	AS7b	
Nyimur	AS8	AS8a	Nyimur	

4.1.3 Land cover

Land cover in the Aswa Catchment is dominated by subsistence farmland, which constitutes over 33% of the land area. The catchment is characterised by subsistence agriculture activities and livestock grazing, with an estimated forest coverage of 5,125km² (18.62%) of the total catchment area. The natural forest categories included and selected from National Forest Authority (NFA) land cover are woodland, woodland temporarily wet and tropical high forest low stocked. This distribution of land cover is partly attributed to climatic conditions and human activities.

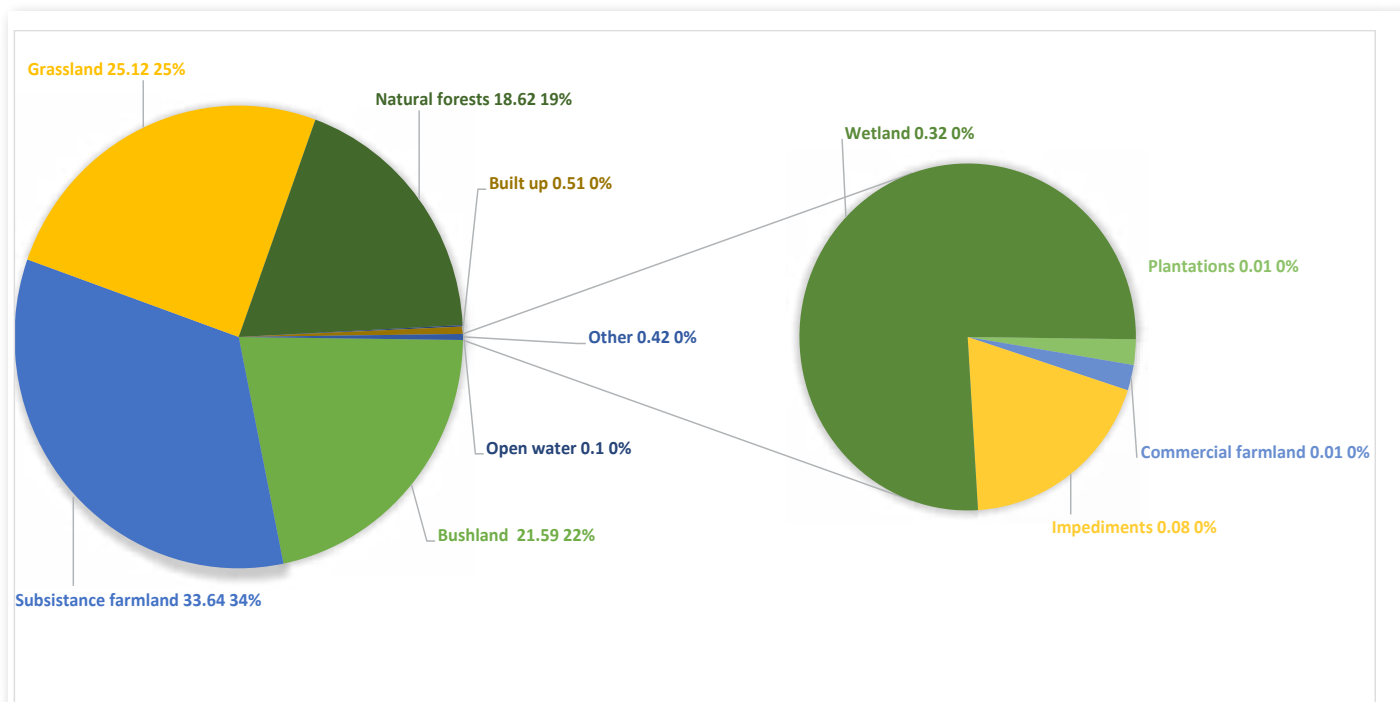

Figure 4.3: Distribution of land cover classes in Aswa

in the Aswa Catchment (where the wetland category refers only to the swamp and papyrus vegetation) covers about 88km² and it represents therefore the 0.32% of the total catchment area while open water covers only about 0.1%.

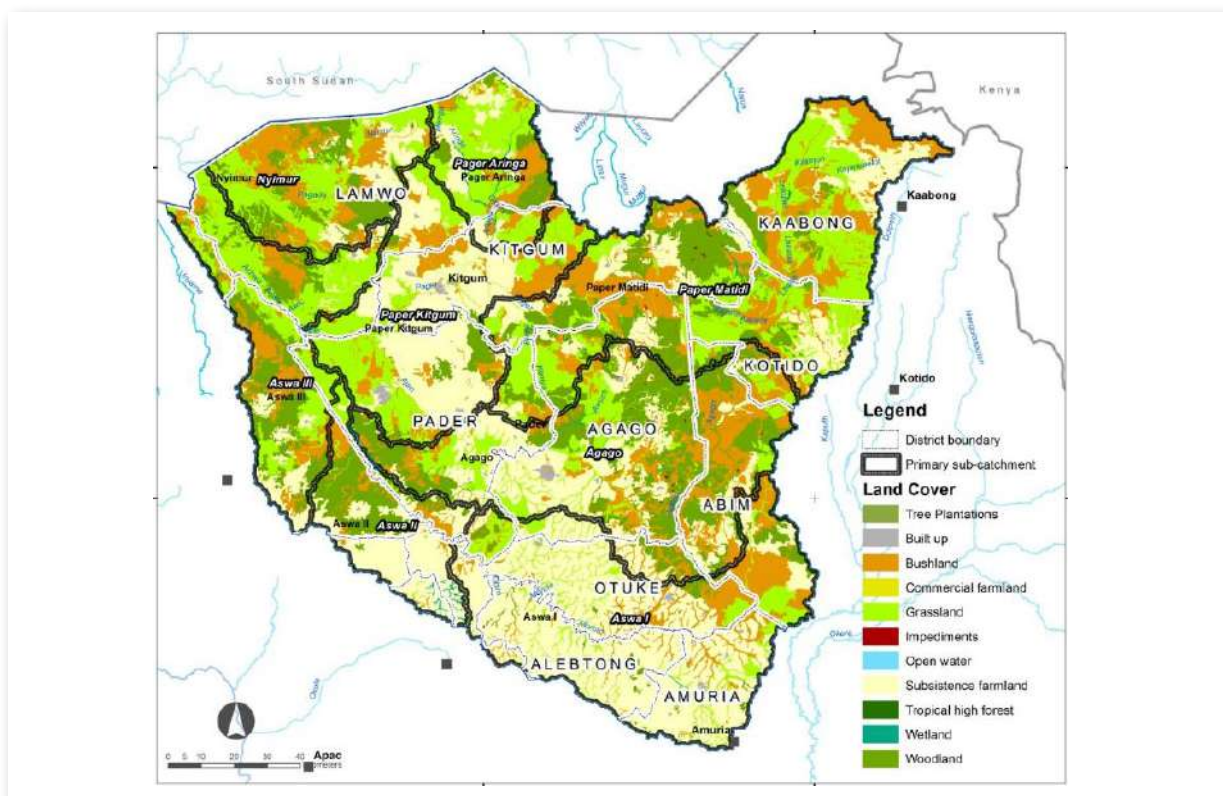

Figure 4.4: Land cover in the Aswa Catchment

4.1.4 Climate

The Aswa Catchment registers an average annual rainfall of about 1,200mm, the highest single annual amount being slightly more than 1,420mm and the lowest being about 1,000mm. Figure 4.4 shows the mean monthly rainfall pattern for the entire catchment.

Temperature analysis indicates highest values between January and March (31-33°C) and the lowest between July and August (27-29°C). Minimum temperatures are generally more homogenous during the year (2°C of variation) and for the four stations monthly means range between 17 and 21°C. The mean temperature during the year within the entire catchment is about 24°C. This area experiences high rates of evapotranspiration, which has a resultant effect on runoff, groundwater recharge and dry season flows, increasing drought risks.

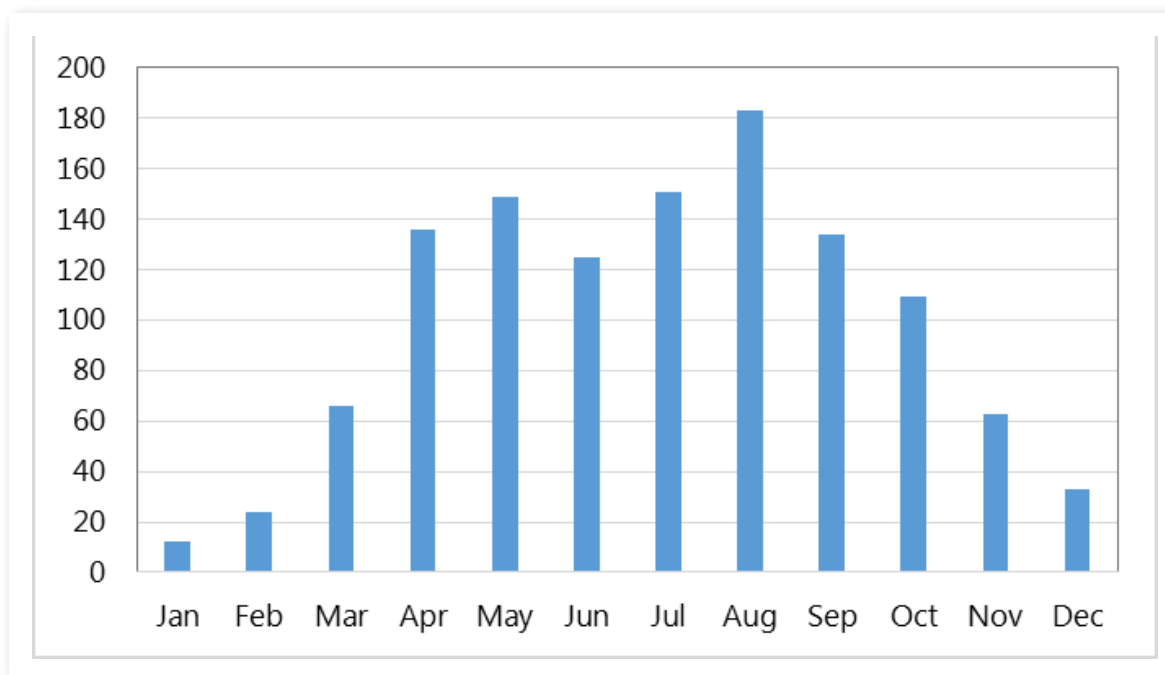

Figure 4.5: Mean monthly rainfall pattern

4.1.5 Geology and Soils

The central part of Upper Nile WMZ is underlain by Precambrian crystalline basement rocks which were formed some 3,000 million years ago and have been modified and altered by subsequent geological events including the rifting and volcanic activity, as well as the deposition of associated sediments. Banded gneisses are present in the western parts of the catchment in West Nile. Rocks are overlain by predominantly ferrallitic, and to a lesser extent ferruginous soils. Some parts of this area are rich in iron and aluminium due to the leaching of other minerals.

4.2 Water Resources

The availability of water resources within the Aswa Catchment is spatially variable and dependent on both surface and groundwater. This section of the CMP presents an assessment of water availability based on the mean hydrological year and drought hydrological year for the current and projected situations for 2030 and 2040 under climate change. The main sources of surface water in the Aswa Catchment are rivers, lakes, permanent and temporary wetlands while recharge is considered to be the main input to the groundwater resource. An assessment of infrastructure utilising this water resource has been made and is presented in the water demand section.

4.2.1 River Systems, Lakes and Wetlands

River Aswa is a major river in north-eastern Uganda, which flows north-west into South Sudan and joins the White Nile. The river originates in hills in the north-western part of Katakwi District and flows through Lira District and becomes the border between the provinces of Pader and Gulu districts where its two main tributaries, River Agago, and then the River Pager flow into it. River Aswa forms most of the border between Atiak and Kitgum before crossing into Sudan east of the border town of Nimule and joining the White Nile about 10 miles northwest of Nimule.

There exists a network of wetlands along the river course, Figure 4.5, with only swamp and papyrus vegetation covering about 88km², representing about 0.32% of the total catchment area. However, wetlands, according to the WMD interpretation, are found also in other land cover types (such as grasslands, woodlands or bushlands) that can be permanently or temporarily waterlogged. According to this interpretation the wetlands in the Aswa Catchment cover about 2,045 km² which represents about 7% of the catchment area. The 7% of wetland coverage is composed by a 1% of permanent wetlands; the remaining 6% is formed by temporary wetlands. Temporary wet-lands in the Aswa Catchment are dominating meaning, therefore, that they are more vulnerable to pressures and more difficult to preserve.

From the information reported in NEMA State of Environment (2012) as well as from the districts' wetland inventories most of the wetlands in the catchment are affected by encroachment and degradation to various extents. The main problems and issues that are associated with wetland ecosystems are charcoal burning, cultivation, dam construction, grassland burning for cattle grazing, pollution from fertilizers used in tobacco and cotton cultivations, human settlements, sand and clay mining, soil erosion and soil infertility, and shea nut butter harvesting.

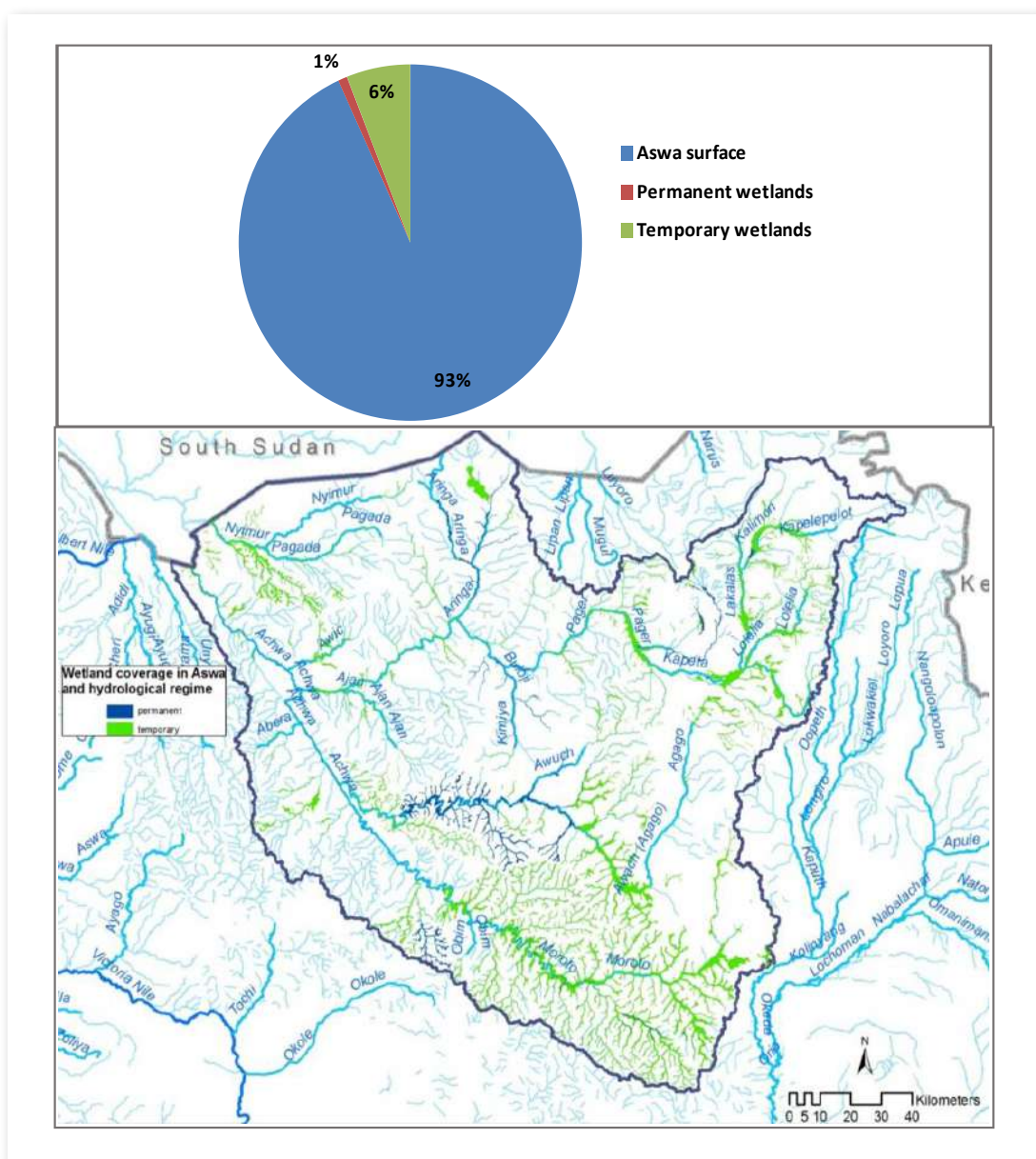

Figure 4.6: Wetlands in the Aswa Catchment

4.2.2 Climate Change

Climate change is a major driver to water resources availability and, therefore, was analysed to assess its impact on available water for the periods 2030 and 2040. This was done in order to assess water availability against demand for water allocation purposes. In particular, data regarding future projections for 2030-2040 for the main climatic variables (temperature and rainfall) was considered for the analysis. It was found that within the spectrum on temperatures in Uganda, and in particular for the mean annual value (about 24°C), potential evapotranspiration shall increase by about 7% in 2030 and 10% in 2040. Rainfall is seen to generally increase in intensity thereby causing increased flooding. These results were included in the water resources assessment and water balance scenarios as seen in the subsequent sections.

4.2.3 Water Availability

The water resources assessment provides the water resources availability in the current mean hydrological year, associated with the current condition on surface network and groundwater system in a pristine scenario, and the characterisation of the drought year, including the impact of climate change in 2030 and 2040. A monthly water-balance model was used to examine the various components of the hydrologic cycle (for example, precipitation, evapotranspiration, and runoff). Surface flows were estimated using a conceptual rainfall-runoff model linking climate to runoff and estimates of potential groundwater recharge were derived from water balance model. The water balance study was conducted combining water resources and water uses in four water balance scenarios:

- Scenario 1: mean hydrological year and water use for 2015
- Scenario 2: drought hydrological year and water use for 2015
- Scenario 3: mean hydrological year with climate change at 2030 and water use for 2030;
- Scenario 4: mean hydrological year with climate change at 2030 and water use for 2040.

Table 4.2 below shows the available surface water within the Aswa Catchment for each of the scenarios, together with the recharge rates.

Table 4.2: Surface Water Availability and Groundwater Recharge

Scenario	Scenario description/Name	Resource (MCM/Yr)	
		Overall	GW recharge
1	Mean hydrological year	2,060	1,351
2	Drought hydrological year	1,012	678
3	Mean hydrological year - climate change 2030	1,704	1,124
4	Mean hydrological year - climate change 2040	1,570	1,037

The distribution of the resources in the sub-catchments is as shown in Table 4.3 below, together with a comparison of the variations from the mean hydrological year, 2015.

Table 4.3: Sub-catchment water availability



Table 4.3: Sub-catchment water availability

COMPARISON BETWEEN THE CURRENT SITUATION AND OTHER SCENARIOS - OVERALL RESOURCES						
Primary sub-catchment	Secondary sub-catchment	Scenario 1 - CURRENT SITUATION (MCM/Yr)	Variation of overall Resources from Scenario 1			
			Scenario 2 - Dry	Scenario 3 - Mean, 2030	Scenario 4 - Mean, 2040	
Aswa I	AS1a	86	-0.58	-0.21	-0.28	
	AS1b	160	-0.51	-0.18	-0.24	
	AS1c	156	-0.51	-0.17	-0.23	
	AS1d	102	-0.51	-0.17	-0.23	
Agago	AS2a	67	-0.66	-0.27	-0.36	
	AS2b	47	-0.64	-0.48	-0.61	
	AS2c	75	-0.57	-0.43	-0.56	
Aswa II	AS3a	114	-0.44	-0.12	-0.17	
	AS3b	219	-0.42	-0.12	-0.16	
Paper Matidi	AS4a	60	-0.76	-0.3	-0.4	
	AS4b	88	-0.56	-0.21	-0.28	
Pager Aringa	AS5a	46	-0.63	-0.27	-0.38	
Pager Kitgum	AS6a	155	-0.48	-0.17	-0.23	
	AS6b	162	-0.47	-0.16	-0.23	
Aswa III	AS7a	239	-0.43	-0.12	-0.17	
	AS7b	195	-0.45	-0.14	-0.2	
Nyimur	AS8a	206	-0.47	-0.16	-0.22	
Aswa	2,177	-0.57	-0.23	-0.31		

Overall, there is general reduction in resources available when compared with the current mean hydrological year (2015) for both the dry hydrological year and the climate change projections for 2030 and 2040. For most of sub-catchments, the water availability is affected by climate change in 2030 in terms of 10-20% of reduction in comparison with current mean hydrological year; except for Pager Matidi and Agago sub-catchments where this decrease is slightly less than 30% and 45% respectively. In 2040, the above mentioned values generally ranges between 15% and 30%, while they reach about 35% and 50% in the eastern portion of Aswa River basin. Groundwater recharge is generally from 55% to 70% of overall resource for all secondary sub-catchments.

Table 4.4 shows the variation of groundwater recharge for all the other scenarios from the current hydrological year, Scenario 1.

Table 4.4: Variation of groundwater recharge from the Current Scenario

COMPARISON BETWEEN THE CURRENT SITUATION AND OTHER SCENARIOS						
GROUNDWATER RECHARGE						
Primary sub-catchment	Secondary sub-catchment	Scenario 1 - CURRENT SITUATION (MCM/Yr)	Variation of overall Resources from Scenario 1			
			Scenario 2 - Dry	Scenario 3 - Mean, 2030	Scenario 4 - Mean, 2040	
Aswa I	AS1a	60	-35	-12	-17	
	AS1b	112	-57	-20	-27	
	AS1c	109	-56	-18	-25	
	AS1d	71	-36	-12	-16	
Agago	AS2a	40	-26	-11	-14	
	AS2b	28	-18	-14	-17	
	AS2c	45	-25	-19	-25	
Aswa II	AS3a	74	-32	-9	-13	
	AS3b	142	-60	-17	-23	
Pager Matidi	AS4a	33	-24	-9	-13	
	AS4b	48	-26	-10	-13	
Pager Aringa	AS5a	29	-17	-7	-10	
Pager Kitgum	AS6a	101	-47	-16	-23	
	AS6b	105	-49	-17	-23	
Aswa III	AS7a	167	-72	-20	-28	
	AS7b	136	-62	-19	-27	
Nyimur	AS8a	124	-57	-19	-26	
Aswa	1,427	-698	-249	-341		

4.2.4 Water Quality

Since the economy of Uganda is still predominantly agricultural, organic matter and nutrients are the major pollutants of the aquatic environment, therefore, the considered pollutants were organic matter, measured through the Biological Oxygen Demand (BOD), total nitrogen (TN) and total phosphorous (TP).

The quality of a given water resource is determined by natural factors and impacts from human activities which can be regulated to some degree, therefore, anthropogenic pollution were considered to identify how human activities can be regulated in order to manage water quality issues. The parameters used for estimation of pollutant loads contained in the NWRA were the basis of the analysis. The Population and Housing Census (2014) was considered in order to update pollution load estimates and future scenarios were created based on future population estimations and future water demand. The main pollution sources from human activities considered were population, livestock, agriculture, aquaculture, and industry.

For each pollution source, the amount of pollutant was estimated based on the number and type of "polluters", through some parameters indicating how much pollutant is produced by a polluter.

It was observed that pollution related to agriculture, aquaculture, and industry is still quite low and negligible compared to pollution from livestock and population. However, the expected increase of intensive systems in aquaculture and the industrial development will lead to increases use of fertilizers and other chemicals in agriculture which are a potential threat to water quality.

4.2.5 Floods and Droughts

The topography of the Aswa Catchment coupled with a tropical climate's rainfall intensity and/or local or regional land degradation issues like deforestation and wetland drainage or the construction of hydraulic structures that create flow blockage, increase the potential flood risk and vulnerability of local population, infrastructure and economic activities in flood-prone areas. Flood risk is exacerbated by the modifications to the runoff characteristics due to deforestation resulting from the increased population pressure in the catchment areas in particular close to the water bodies such as river flood prone areas or wetlands. Apart from damage in the floodplain areas, direct damage from floods in the Aswa Catchment is typically limited while indirect damage e.g. outbreaks of water borne diseases among people and livestock, displacement of population, and cutting of key transport links, are reportedly more significant.

In the Aswa Catchment, two flood events were reported both during the 2007 extreme rainfall events. One of those events has been published by United Nations Institute for Training and Research (UNITAR-UNOSAT) and is shown below together with a mapping of the affected areas of Aswa river courses. This type of flooding is difficult to alleviate with the usual flood protection measures (detention storage, river course alignments, etc.), which are more suited to river overbank flooding.

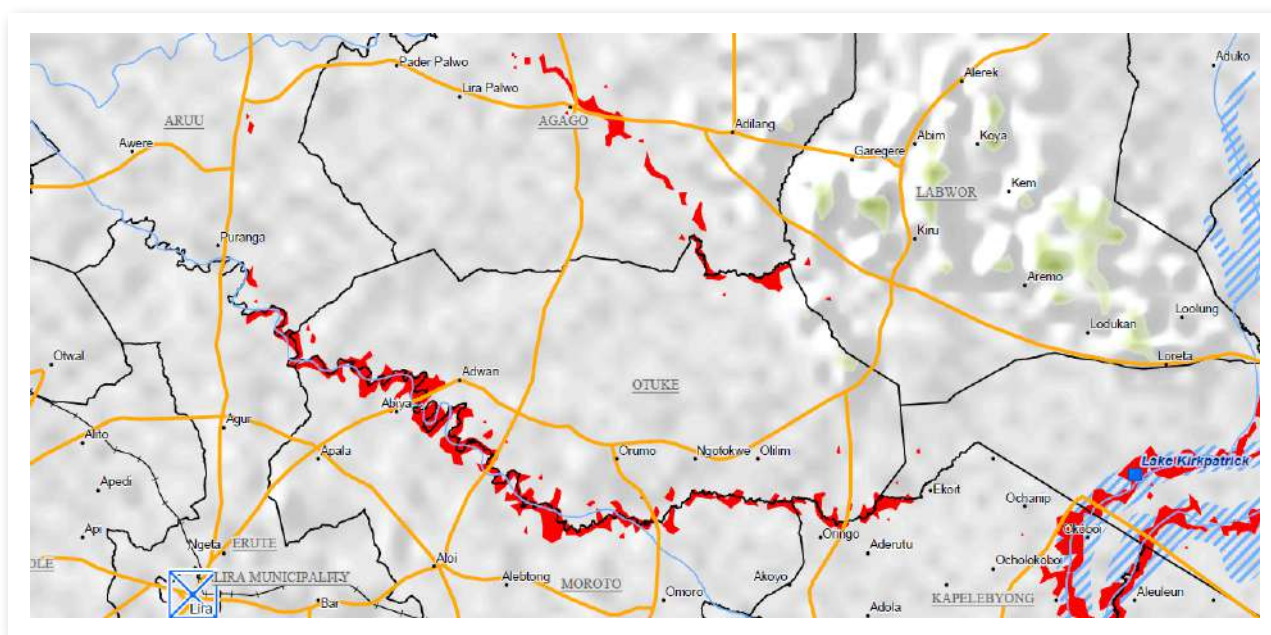

Figure 4.7: Historical flood events affecting the study area of the Aswa river (September-October 2007- Map compiled by WFP Emergency Preparedness and Response Branch [ODAP])

ce the direct consequences of floods are usually limited with respect to the indirect ones (such as spreading of water-borne diseases), the proper strategy in this case is to develop a more suitable land use planning and management system taking explicitly into account the extent and return time of both ordinary and extreme flood events in rivers and wetlands.

The drought year varies from about 80% to 84% of the mean year within the Aswa Catchment.

4.3 Water Demand

4.3.1 Current Water demand

The current and projected water demand within the Aswa Catchment was categorised based on the user category, with the main categories considered being;

- 1) Water for people/Domestic water; this was estimated using population and per capita consumption relative to each type of user
- 2) Water for production:
 - a) Crop; this was estimated using crop production, the cultivated area, and the crop water requirements
 - b) Livestock; this was estimated using the livestock density and the per capita consumption
 - c) Water for industry; this was computed as a total of water demand for mining and quarrying, manufacturing, construction, and food processing activities within the catchment.
- 3) Water for energy; this was computed as the total requirement for both the hydropower plants and thermal plants.



The tables below summarise the gross water demand for these categories of water users at a sub-catchment level.

Table 4.5: Current gross water demand

		WATER USE 2015									
		Area (Km ²)	Gross demand (m ³ /y)								
Primary sub-catchment	Secondary sub-catchment		Water for people			Water for production					Water for energy
			from SW	from GW	Total	from SW Industries	from SW Livestock	from SW Fishery	from SW Crops	Total	from SW
Aswa I	AS1a	1430	39,202	394,257	433,459	32,382	1,122,296	0.0	7,428,693	8,583,371	0
	AS1b	1472	143,313	433,308	576,621	44,005	1,520,138	0.0	6,363,837	7,927,980	0
	AS1c	1274	202,604	353,939	556,543	40,123	1,162,354	0.0	844,086	2,046,564	0
	AS1d	888	80,841	276,683	357,524	23,812	601,098	0.0	866,291	1,491,200	0
Agago	AS2a	2620	83,561	500,527	584,088	40,152	3,166,246	0.0	1,972,353	5,178,751	0
	AS2b	1227	47,718	255,092	302,811	21,438	447,676	0.0	97,465	566,579	0
	AS2c	1262	28,039	246,097	274,135	19,780	460,710	0.0	229,124	709,615	0
Aswa II	AS3a	554	142,747	319,306	462,053	31,383	492,617	0.0	2,339,076	2,863,076	0
	AS3b	1034	281,347	318,821	600,167	37,314	523,531	0.0	323,288	884,133	0
Paper Matidi	AS4a	4716	73,927	655,285	729,212	53,707	15,452,320	0.0	4,596,787	20,102,814	0
	AS4b	1539	52,171	296,953	349,124	23,605	561,570	0.0	246,716	831,891	0
Pager Aringa	AS5a	1493	17,046	153,204	170,250	11,611	544,852	0.0	8,191,939	8,748,402	0
Pager Kitgum	AS6a	1700	47,883	264,532	312,415	19,882	620,441	0.0	302,716	943,039	0
	AS6b	1717	27,628	306,978	334,606	24,098	626,523	0.0	353,226	1,003,847	0
Aswa III	AS7a	1088	366,471	286,228	652,699	36,966	397,099	0.0	344,400	778,465	0
	AS7b	1579	197,369	363,043	560,412	36,910	961,954	0.0	203,383	1,202,248	0
Nyimur	AS8a	2084	13,784	183,135	196,920	13,945	760,528	0.0	181,886	956,359	0

Table 4.6: Current net water demand

		WATER USE 2015									
Primary sub-catchment	Secondary sub-catchment	Area (Km ²)	Net demand (m ³ /y)								Water for energy from SW
			Water for people			Water for production					
			from SW	from GW	Total	from SW Industries	from SW Livestock	from SW Fishery	from SW Crops	Total	
Aswa I	AS1a	1430	30,073	314,023	344,096	1,943	1,066,182	0.0	7,057,258	8,125,383	0
	AS1b	1472	114,011	363,666	477,677	2,640	1,444,131	0.0	6,045,645	7,492,417	0
	AS1c	1274	162,431	278,834	441,265	2,407	1,104,236	0.0	801,882	1,908,526	0
	AS1d	888	49,173	192,167	241,340	1,429	571,043	0.0	822,976	1,395,448	0
Agago	AS2a	2620	44,205	359,450	403,655	2,409	3,007,934	0.0	1,873,735	4,884,078	0
	AS2b	1227	34,992	187,191	222,184	1,286	425,292	0.0	92,592	519,170	0
	AS2c	1262	21,162	187,689	208,851	1,187	437,675	0.0	217,668	656,530	0
Aswa II	AS3a	554	88,289	224,956	313,246	1,883	467,986	0.0	2,222,122	2,691,991	0
	AS3b	1034	132,819	208,491	341,310	2,239	497,355	0.0	307,123	806,717	0
Pager Matidi	AS4a	4716	107,781	498,393	606,175	3,222	14,679,704	0.0	4,366,948	19,049,874	0
	AS4b	1539	35,788	206,957	242,745	1,416	533,492	0.0	234,380	769,288	0
Pager Aringa	AS5a	1493	11,699	109,782	121,481	697	517,609	0.0	7,782,342	8,300,648	0
Pager Kitgum	AS6a	1700	30,319	171,115	201,434	1,193	589,419	0.0	287,580	878,192	0
	AS6b	1717	31,683	234,843	266,526	1,446	595,197	0.0	335,565	932,208	0
Aswa III	AS7a	1088	193,546	154,894	348,440	2,218	377,244	0.0	327,180	706,642	0
	AS7b	1579	126,323	260,195	386,518	2,215	913,857	0.0	193,214	1,109,286	0
Nyimur	AS8a	2084	10,379	137,893	148,272	837	722,501	0.0	172,792	896,130	0

4.3.2 Projected Water Demand

For each use, the future water demand was calculated through assumptions regarding future scenarios. The main assumptions are related to the projected population growth, the planned increase of per capita water consumption and the per capita income increase (GDP) according to the national planning framework objectives and development trends. The population growth rates used for periods 2015-2030 and 2030-2040 are 3.2% and 2.4% respectively, as derived from Uganda Vision 2040.

For domestic water, population growth rates were used along with per capita water consumption which is expected to increase, since current values are quite low and economic growth usually leads to increased water consumption. In order to estimate per capita consumption for 2030 and 2040, a yearly domestic specific consumption growth of 6% (2015-2030) and 5.3% (2030-2040) was assumed.

For the industrial and tourism sector, most of parameters were directly related to the per capita income expected growth that was assumed to be an annual increase of 10.3%; calculated based on the Uganda Vision 2040, where the per capita income is expected to rise from a current baseline of US\$506 in 2010 to a target of US\$9,500 in 2040. This growth rate was used to estimate the number of industrial and tourism water users. The per capita consumption rates for tourists and public employees was also increased using the same growth rate.

4.4 Water Balance

The water balance is presented for all the four scenarios at primary sub-catchment level as shown in Table 4.7 and Table 4.8 below. In this section, the following notations have been used to mean;

- P – Precipitation
- AET – Actual Evapo-transpiration
- Pnet – Net Precipitation
- BF – Baseflow,
- GW – Groundwater
- SW – Surface Water.

Table 4.7: Water balance for the mean and drought hydrological years

Primary Sub-catchment	MEAN HYDROLOGICAL YEAR				DROUGHT HYDROLOGICAL YEAR			
	P (mm)	AET (mm)	Pnet (mm)	BF (mm)	P (mm)	AET (mm)	Pnet (mm)	BF (mm)
Aswa III	1,281	1,119	163	49	1,058	968	91	27
Pager Kitgum	1,240	1,147	93	32	1,039	992	47	17
Nyimur	1,202	1,103	99	40	1,002	952	50	20
Pager Aringa	1,142	1,056	86	34	942	901	41	16
Pager Matidi	996	972	24	11	804	797	7	3
Agago	1,169	1,133	36	14	966	952	14	6
Aswa II	1,397	1186	211	74	1,148	1029	119	42
Aswa I	1,283	1183	100	30	1,060	1013	47	14



Table 4.8: Water balance for the mean hydrological year under climate change projections for 2030 and 2040

WATER BALANCE - MEAN HYDROLOGICAL YEAR CLIMATE CHANGE								
Primary Sub-catchment	2030				2040			
	P (mm)	AET (mm)	Pnet (mm)	BF (mm)	P (mm)	AET (mm)	Pnet (mm)	BF (mm)
Aswa III	1,281	1,140	142	43	1,281	1,148	134	40
Pager Kitgum	1,240	1,163	77	27	1,240	1,169	71	25
Nyimur	1,202	1,134	68	27	1,202	1,146	57	23
Pager Aringa	1,142	1,071	72	29	1,142	1,076	66	26
Pager Matidi	996	979	17	8	996	981	15	7
Agago	1,169	1,141	28	11	1,169	1,144	25	10
Aswa II	1,397	1212	185	65	1,397	1222	175	61
Aswa I	1,283	1201	81	24	1,283	1208	74	22

A comparison of the available water and demand indicates a very low ratio between water demand and water availability for all the scenarios as shown in Table 4.9 below.

Table 4.9: Comparison of water demand and availability

Scenario	Resource (MCM/Yr)	Gross demand (MCM/Yr)	Net demand (MCM/Yr)		Total	from SW	from GW	Total
	Overall	GW recharge	from SW	from GW				
Mean hydrological year	2,060	1,351	47	5.5	53	44	4	48
Drought hydrological year	1,012	678	51	5.5	56	47	4	51
Mean hydrological year - climate change 2030	1,704	1,124	1,299	21	1,320	503	15.2	518
Mean hydrological year - climate change 2040	1,570	1,037	1,958	44.7	2,002	903	32.6	935



4.5 Social and Environmental State

The overall purpose of the Strategic Social and Environmental Assessment is to identify major social and environmental issues that must be taken into account in the planning process and that could inform the plans' outcome. The social and socio-economic baseline emerges from the demographic and population characteristics of the catchment, the socio-economic profile, the poverty status, an analysis of the livelihoods at risk, and gender and vulnerable groups. From this analysis and from stakeholder consultations the main issues, vulnerabilities and challenges that have emerged are:

- The majority of the population in the basin is rural
- Some districts have very low population densities
- Life expectancy is very low (many outbreaks of disease and high maternal mortality rates)
- Social conflicts related to land availability, cattle rustling, human-wildlife conflicts
- Displaced people as a result of intra-tribal raids and hard climatic conditions
- Nomadic way of life and dependence from cattle
- South Sudanese refugee camps causing frictions with local communities
- Land conflicts
- Critical dependency on natural resources.

4.5.1 Population and demography

The estimated population of all the 15 districts covered by the Aswa Catchment, based on the provisional results of the Population and Housing Census (2014) is 3,292,176 (UBOS, 2014), and using the available spatial and statistical data, 55.45% (1,825,667 people) of these live within the catchment. There are substantial differences between the districts, in terms of their population with Otuke and Abim districts having the lowest populations while Gulu, Lira, and Oyam have comparatively higher population in the Aswa basin. The majority of the population in the catchment is rural dominant depending entirely on subsistence farming.

Although most of the districts in the Aswa Catchment reflect population growth rates of 3.0%, the catchment has some areas of high population growth of 9.4% (Kaabong). The poverty headcount is high for Lira and the Karamoja sub region compared to other districts. For populations that rely heavily on natural resources, this is likely to put a lot more pressure on the natural resources with time. Table 4.10 shows a summary of the demographic characteristics of the districts within the Aswa Catchment whose data was available, the others had with missing data at the time of this undertaking.



Table 4.10: Summary of demographic characteristics of the Aswa Nile districts

S/N	DISTRICT	Population Density	Population Growth rate	Urbanisation	Dependency Ratio	Poverty Headcount
1	Abim	40	5.2%	15%		85%
2	Alebtong	65				
3	Amuria	121	3.2%			46%
4	Gulu	129	2.9%		1:2	46.2%
5	Kaabong	23	9.5%	6.50%	1:15	66%
6	Kitgum	50				
7	Lira	306				71%
8	Otuke	64	4.44%			
9	Oyam	173				
10	Pader	55	2.13%	11.8%	1:09	58%

Source: District Development Plans (ending FY2013/2014)

4.5.2 Social-economic Profile

From 1986 to 2007, the Aswa basin was under the war/conflict caused by the Lord's Resistance Army which led to massive displacement of people among many other issues. Geographically, the war was concentrated in the Acholi sub region, and to a lesser extent in the Lango sub regions.

Rain fed agriculture is the most practiced land use with over 80% of the population depending on it based on two planting seasons. Profitability from farming in the catchment is low with high risks of exposure to flood and drought and loss of yields. Grazing and pastoralism are practiced under the same conditions as agriculture and they are, therefore, completely dependent on rain water for water points and grassland availability. In the basin it is recognised a potential for agricultural and grazing improvement on condition of being able to manage water flows and water allocation .

However, a combination of social, economic, and technological factors are beginning to constitute major drivers of land use in the basin. Most notably are incentives towards afforestation and commercialisation of agriculture, technology adoption in agriculture is expanding, thus creating major shift in land use. The main socio economic issues that have and can take advantage of the Water Resources management within the basin include:

- Industries: Particularly agro-processing industries (maize, oil seed etc) found in major towns and municipalities such as Gulu and Lira. It is also foreseen by Uganda Vision 2040 that an agro-processing hub will be developed in Gulu area
- Fishing: Tonnes of fish are harvested from wetlands found in the Aswa Catchment together with ponds on fish farms. Fishing activities have become so popular that these activities have become of increasing concern especially on quality of water resources and on the sustainable harvest yield
- Water Supply and Sanitation: Most of the water supply and sanitation systems found within the towns and municipalities located in the catchment use the vast water resources found within; however sanitation networks and facilities are still well below the desired national targets
- Energy from Hydropower: There are plans to develop hydropower projects within the Aswa basin. The most notable is the Achwa Hydro Power Project ("Achwa HPP2") and ("Achwa HPP1") by ARPE Ltd - a developer of renewable energy projects in Uganda. The Achwa Hydropower Projects – 2 and 1 are located in close proximity on Achwariver approximately 19km north-west (downstream) of the new Achwa Bridge on the Gulu-Kitgum road. The new bridge is almost half way between Gulu and Kitgum (40km north from Gulu and 60km south from Kitgum).

In general, but especially in Karamoja, there are very poor roads. Districts are connected through gravel murrum-roads, which are periodically washed away by seasonal rains, hence rendering the region inaccessible. This scenario has hampered effective delivery of social services and economic activities in the region.

Employment revenue, which is the second most important source of income at the national level, is only 7.2% within the basin compared with 22.8% in the Central Region of Uganda . Most people tend to rely for sustenance and income on land cultivation and herding. In addition to farming and herding, more households (and especially women within households) are now working outside of the home and participating in the labour market.

Like many parts of the country, the prevalence of HIV/AIDS remains one major challenge within the zone. Although Uganda has made monumental strides in decreasing the prevalence of the disease, since 2006 there has been a slight increase again. Current HIV prevalence in Uganda is estimated at 6.5% among adults and 0.7% among children. Women are disproportionately affected, accounting for 57% of all adults living with HIV.

4.5.3 Poverty Status

Poverty studies conducted by the Ministry of Finance, Planning and Economic Development characterise poverty as poor, non-poor insecure and the middle class . The catchment has a greater proportion of poor people compared to other parts of the country. Poor people are in a range of 35.2% to 42.3% while the non-poor insecure population ranges from 40.4% to 41.4%, leaving a mere 17.3% to 23.2% of the population within the catchment in the middle class. This presents a challenge but also an opportunity to water resources management and development.

4.5.4 Key Social Issues and Implications

High population density is seen to be the main driver to social-environmental issues since it creates pressures on the environment and additional competition for land. In fact, competition over natural resources (land, oil, forests and minerals) is identified as one of the main drivers of social conflicts in Northern Uganda (Northern Uganda Conflict Analysis, ACCS, 2013).

Through this assessment, a mapping of key social issues that needed to be considered in the planning process included:

Table 4.11: Key social issue and implications

	Issue	Implication
1	High population growth	Increased pressure on water and related resources
2	Heavy dependence on rain fed agriculture	Food insecurity leading to increased poverty levels and rural-urban migration Encroachment of wetlands in search of sustainable water supplies
3	Increased urbanisation	Increased pressure on water resources
4	Climate Change and variability in seasonal rainfall	Food insecurity
5	Refugee camps and resettlement issues	Conflicts over land and related resources
6	Land ownership	Conflicts and disputes over land which ultimately hampers development
7	Wetland and protected area encroachment	Loss of wetlands and protected areas
8	High poverty levels	Increased pressures on the environment and natural resources. Social conflicts and disputes

4.6 Stakeholders

The involvement of Stakeholders in the planning process was fundamental for the accomplishment and implementation of the Aswa Catchment Management Plan.

4.6.1 Stakeholders Identified

A wide spectrum of stakeholders at national, regional, district, and local levels within and outside the catchment were identified and consulted during the development of the CMP. A broad array of stakeholders engaged are indicated in Table 4 11.

Table 4.13: Stakeholders engaged

KEY STAKEHOLDER	INTERESTS	ROLES AND RESPONSIBILITIES
MWE DWRM DEA-WMD DWD NEMA NFA UWA	Sustainable use of re-sources and management	Creating the enabling environment for the integration of social and environmental issues into catchment management, formulating guidelines, policies and institutional frameworks, provide relevant information and technical support
WMZ Team	Sustainable use and management of water resources in an integrated manner	Practical implementation and enforcement of the IWRM approach and integration with the local social and environmental concerns
Upper Aswa SCMC	Sustainable use and allocation of water resources	Integration of planning about water resources at sub-catchment and catchment scale
District Water Office (DWO)	Access to resources and services that are essential to meet the needs of the persons they represent	Information about water sources (Ground Water /Surface Water), water supply system, water quality, access to safe drinking water programmes, water source and catchment conservation initiatives management
District Environment Committee (DEC)/Office		State of environment information and reports, including wetlands, forests and relevant by-laws enactment
District Forestry Office (DFO)		Forest status and forestry management plans, forest reserves information
District CAO		District profiling and general information
District Community Development Office (DCDO)		Population records, community services organization and management, welfare and poverty profiles, gender and vulnerability issues
District Planning Unit (DPU)		Planning and investments (district investment profiles)
NGOs (social and environmental)	Sustainable resources use livelihoods and social development	Capacity building, awareness raising, implementation of social and environmental projects
Local water supply and sanitation NGOs under the UWASNET network	Sustainable use of water resources	Management of water supply systems, monitoring, capacity building technical and financial assistance
Private Companies and enterprises	Use of natural and water resources for profit	Exploitation of natural and water resources, land and water limitation of uses/constraints, financial assistance for social and environmental projects

The Identified stakeholders were analysed for their Strengths, Weaknesses, Opportunities and Threats (SWOT) for strategic and risk assessment reasons.

4.6.2 Stakeholder Issues' mapping

The identified stakeholders, through a number of consultative meetings, focused interviews, and questionnaires, helped identify and map issues regarding water resources management and development within the catchment. These issues are analysed and options for water resources management infrastructure development packaged in this plan.

1) Water resources availability issues

- Degraded water quality
- Water scarcity and low water availability
- Poor water quality especially in IDPs areas and water sources
- Poor Operation and Maintenance (O&M) of water facilities and infrastructures
- Scarcity of underground water
- Open defecation and contamination of water sources
- Water quality testing constrained due to lack of capacity and financial allocation
- Water for production is poorly addressed and managed; many dams and storage reservoirs are silted and unusable
- Runoff
- Wells constructed for IDPs and refugee camps are not working anymore but they are accounted as they were
- Silted and unusable dams widely present
- Need of constructing animal water points

2) Environmental issues

- Wetland encroachment
- Water availability for natural ecosystems
- Land degradation
- Bush burning for hunting purposes
- Poor sanitation coverage and pollution
- Siltation of rivers due to erosion and land degradation
- Encroachment of forests and forest reserves
- River bank deforestation and following exposure to river bank erosion
- Bushland clear cutting and degradation
- Overgrazing and pastures degradation
- Car washing inside wetlands and rivers leading to deteriorating WQ
- Use of fertilizers, pesticides, fungicides and insecticides (for tobacco and other cultures)
- Industrial waste discharged into the Okole wetlands
- Waste dumping into wetlands
- IDPs camps have contributed to massive deforestation



3) Social issues

- Long distances for water collection
- Lack of community capacity about O&M activities
- Need of directing communities towards alternative energy sources for their livelihoods (other than charcoal)
- Conflicts with the Turkana people coming from Kenya
- IDPs and Sudanese refugee camps causing conflicts with local communities

4) Institutional issues

- Lack of enforcement of policies, laws and guidelines concerning water management
- Understaffing especially at the district level
- MWE licensing groundwater abstraction but it is perceived by the district that this could be excessive and damage the ground water resources
- Water and environment committees formed with local people shall not operate basing on monetary compensation (as given by institutional bodies and NGOs) because this creates a wrong attitude
- Local leaders contribute to degradation, accepting the sale of wetlands even if it is illegal.

5.1 Guiding Principles

The strategic planning of water resources development and management in the Aswa Catchment is rooted in the Upper Nile Water Resources Development and Management Strategy, which was framed on three guiding principles:

- Equity
- Sustainability
- Efficiency.

The Equity principle includes the social and institutional equity in allocation of resources across different social and economic users and across different areas. The human right to safe water drives the prioritisation of water allocation among different uses and sectors, in order to strengthen an equitable, participatory and accountable water governance in the catchment in line with the strategic goals and objectives established at the national level. The Sustainability principle includes the environmental, social and economic sustainability of water use and management. Water is a finite and irreplaceable resource that is fundamental to human well-being. It is only renewable if well managed and this requires that water is used and allocated in amounts such that the sources and sinks of water remain within their regenerative capacity. Water sustainability refers to the recognition of the enabling role of water resources in supporting and maintaining the integrity and resilience of social, economic and environmental systems over the long term.

The Efficiency principle entails wise and integrated management to promote technical efficiency, in the sense of increasing outputs of available water resources, as well as allocation efficiency of scarce water resources for social and economic development over the timeframe of the Strategy.

5.2 Vision and Strategic Objectives

5.2.1 Vision

A catchment vision is meant to present a collective, medium-to-long term desired future state of the catchment from which strategies that are realistic and locally attainable can be derived. The vision for the Aswa Catchment was adopted from the Upper Nile WMZ Water Resources Development and Management Strategy, which was developed with extensive stakeholder engagement. The vision for the catchment is:

Upper Nile WMZ/Catchment Vision

"A sustainable, equitable and effective water resources management and development for socio-economic transformation by 2040 for the Aswa Catchment"

The Upper Nile Water Resources Development and Management Strategy, which is the origin of the catchment vision, is structured in a suit of five sub-categories that provide the framework for setting strategic objectives and related actions at the WMZ, catchment and primary sub-catchment levels.

The five sub-categories are:



Water Governance is the sub-strategy that addresses the development of integrated water resources management capacity and decision making at the WMZ level including allocation, planning, regulation, monitoring, and control of water resources in a participatory and inclusive management framework



Water for People is the sub-strategy that aims at ensuring the provision of adequate water supply and sanitation and hygiene services to all the urban and rural population of the Upper Nile WMZ



Water for Production is the sub-strategy that aims at allocating water resources to productive uses for the economic development of the Upper Nile WMZ within the national framework of sectoral development goals and objectives



Water for Energy is the sub-strategy that focuses on the increase of renewable energy production through development of hydropower capacity and management of water demand for energy production



Water for Environment is the sub-strategy that aims at ensuring conservation of water related ecosystems and sustainable use natural resources within the Upper Nile WMZ

Each sub-strategy is built on five structural components:

- Monitoring Systems and Information Management
- Water Allocation and Water Demand Management
- Water Infrastructure Development
- Water Resource Management and Environmental Protection
- Public Engagement and Capacity Development

5.2.2 Strategic Objectives

The mission of the Water Resources Development and Management Strategy for the Upper Nile WMZ and the Aswa Catchment is to secure water for all needs up to 2040. In order to achieve this principal goal, the five sub-strategies are coupled with nine strategic objectives, as outlined below.

Table 5.1: Strategic Objectives

Water Governance		1. Equitable, participatory and accountable water governance for sustainable and Inclusive growth and development
Water for People		2. Universal and sustainable access to safe water supply 3. Universal and sustainable access to improved sanitation and hygiene
Water for Production		4. Sustainable use, development and management of water resources in agriculture, livestock, aquaculture and forestry 5. Sustainable use, development and management of water resources for agro-industry, industrial production, Oil and Gas 6. Sustainable use, development and management of water resources for other sectors (tourism, transportation, security)
Water for Energy		7. Sustainable use, development and management of water resources for renewable energy production
Water for Environment		8. Conservation of ecosystem services and functions 9. Mitigation of effects of extreme climatic events

5.3 Key catchment issues

The identification of the issues is fundamental in the determination of options for infrastructure development and water resources management interventions. Catchment issues in the Aswawere sourced from;

- The framework given from National Strategy and UN-WMZ Strategy
- The Water Resources Assessment, Strategic Social Environmental Assessment, and the Water Balance Results for the Aswa
- Stakeholder consultations.

The identified issues are divided into cross-cutting issues that involve the entire catchment or WMZ and specific issues that are evaluated for each sub-catchment. Many water governance issues were identified in the UN-WMZ Strategy and were categorised under five areas:

- 1) Strengthening of policy, legal and institutional framework for IWRM at WMZ and catchment level
- 2) Expand and improve the water resources knowledge base and information management system
- 3) Coordination and cooperation
- 4) Strengthening of institutional capacity for IWRM implementation at WMZ and catchment level
- 5) Strengthening of financing mechanism for IWRM implementation at WMZ and catchment level.

Issues identified under each of the areas are:

Table 5.2: Water Governance Issues

Objective	Issue
Strengthening of policy, legal and institutional framework for IWRM at WMZ and catchment level	Limited enforcement of WRM regulation and lack of compliance with existing standards
	Weak operationalisation of IWRM at WMZ and catchment levels
	Limited integration of IWRM into sectoral and local planning frameworks
Expand and improve the water resources knowledge base and information management system	Inadequate hydro-meteorological monitoring network
	Inadequate water quality monitoring network and laboratory facilities
	Inadequate groundwater monitoring network
	Inefficient WR/WQ information management system
Coordination and cooperation	Limited harmonisation of institutional mandates between national and local government bodies and agencies
	Limited inter-agency cooperation and collaboration
	Weak stakeholder engagement
Strengthening of institutional capacity for IWRM implementation at WMZ and catchment level	Inadequate institutional capacity
	Inadequate technical capacity and lack of tools for water resources allocation
	Low level of awareness
Strengthening of financing mechanism for IWRM implementation at WMZ and catchment level	Insufficient funding for CbWRM
	Limited effective criteria for water resources allocation (high value water use)

Other issues are specific to catchments and are analysed in order to identify options aimed at getting their solutions. Issues have been grouped into categories that are part of four strategic areas, namely: Water for People, Water for Production, Water for Energy, and Water for Environment.

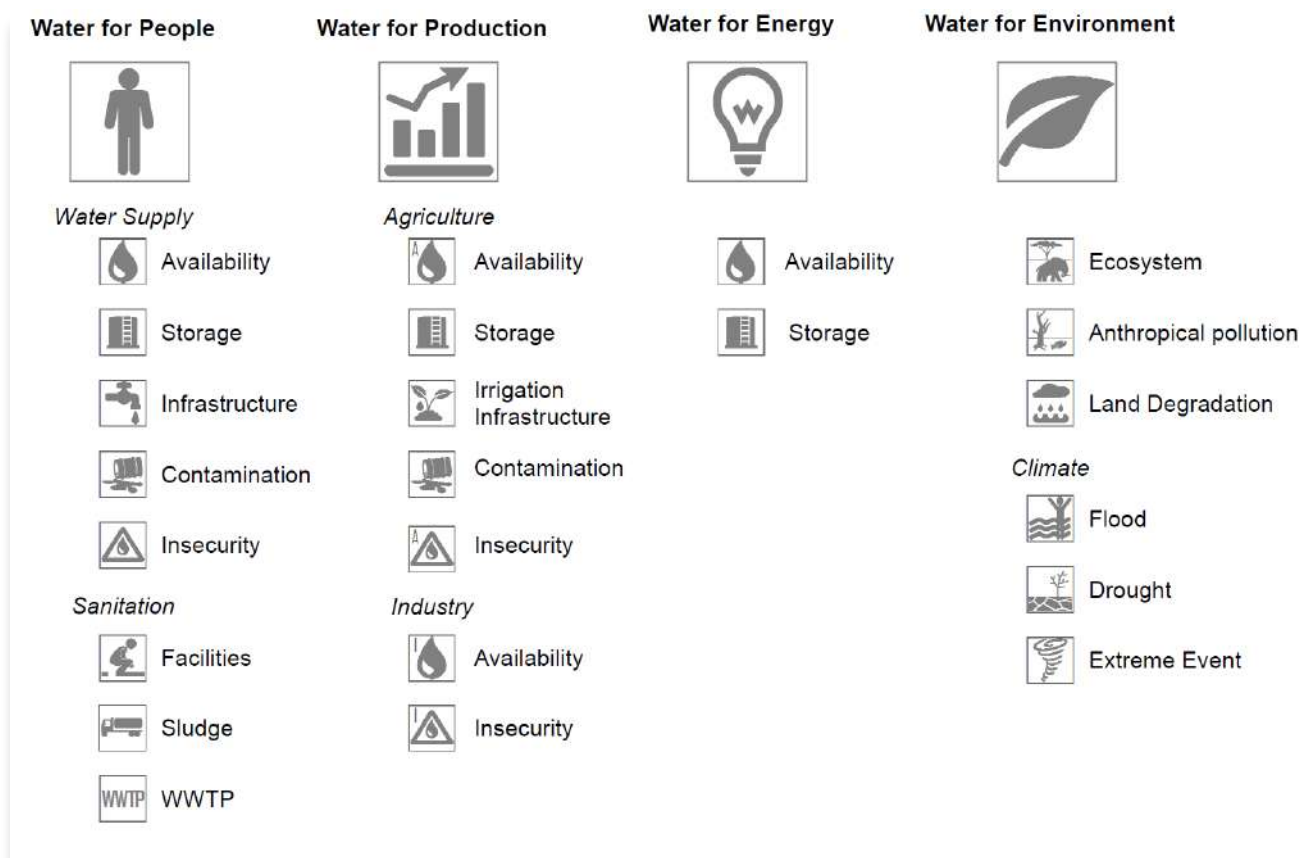

Figure 5.1: Categories and symbols of issues divided into strategic areas

For each category of issues identified, levels of how critical the issue is (criticality degree) in each sub-catchment were assigned and subsequently, issues were prioritised. The criticality degree was given assigning values from 1-5, based on the results of water balance and on other parameters and specific characteristics of the sub-catchments (e. g. land use, topography, existing infrastructures, human activities, etc.). The prioritisation of issues was assessed by weighting issues amongst themselves and weighting issues among different sub-catchments. This identification, assigning degree of criticality, and prioritisation of issues was done in consultation with the catchment stakeholders.

Prioritised Issues

The degree of criticality of issues in specific primary sub-catchments were given colour codes as;

- **Green** medium criticality, issue value 1 or 2;
- **Yellow** high criticality, issue value 3;
- **Red** very high criticality, issue value 4 or 5.



Sub-Strategy	Strategic Issues	ASWA							
		AS1	AS2	AS3	AS4	AS5	AS6	AS7	AS8
		Aswa I	Agago	Aswa II	Pager Matidi	Pager Aringa	Pager Kitgum	Aswa III	Nyimur
		Green	Yellow	Green	Yellow	Green	Green	Green	Green
		Yellow	Yellow	Red	Yellow	Yellow	Red	Yellow	Green
		Yellow	Yellow	Green	Red	Green	Yellow	Green	Green
		Red	Red	Red	Red	Yellow	Yellow	Yellow	Yellow
		Yellow	Yellow	Green	Red	Red	Yellow	Yellow	Green
		Red	Red	Red	Red	Green	Red	Yellow	Yellow
		Red	Red	Red	Green	Green	Yellow	Green	Green
		Yellow	Red	Green	Red	Red	Yellow	Green	Green
		Red	Red	Red	Red	Red	Red	Red	Yellow
		Red	Yellow	Red	Green	Green	Yellow	Green	Green
		Yellow	Yellow	Yellow	Red	Green	Green	Green	Green
		Red	Red	Yellow	Red	Red	Yellow	Yellow	Green
		Green	Green	Green	Green	Green	Green	Green	Green
		Yellow	Yellow	Green	Yellow	Yellow	Yellow	Yellow	Green
		Green	Green	Green	Green	Green	Green	Yellow	Green
		Green	Green	Green	Green	Green	Green	Green	Green
		Red	Red	Red	Yellow	Yellow	Yellow	Red	Yellow
		Yellow	Yellow	Yellow	Red	Green	Green	Green	Green
		Red	Red	Red	Red	Yellow	Red	Yellow	Yellow
		Red	Yellow	Red	Yellow	Green	Yellow	Yellow	Yellow
		Red	Red	Yellow	Red	Red	Red	Yellow	Yellow
		Red	Red	Red	Red	Red	Yellow	Green	Yellow

Figure 5.2: Matrix of criticality of issues in the catchment

5.4 Identification of Opportunities and Options

5.4.1 Potential Opportunities

A range of opportunities exists within the catchment from which, options to address the identified issues were identified. Some of the opportunities include:

- Rainfed agriculture during wet season can be practiced in the western part of the catchment
- The extension of cultivated area can be increased during wet season, while soil conservation practices must be put in place during the dry season in order to avoid that soil cultivated during the wet season is left bare
- The sub-catchment AS8 (Nyimur) shows a water resources surplus compared to demand and the possibility to implement a water storage volume larger than necessary
- Non-intensive fish farming can be practiced inside wetlands, according to law limitations
- Tourism could be developed associated to protected areas, in particular the north-east part of the catchment is particularly rich of protected natural areas that can be exploited for eco-tourism
- There are good potentialities for groundwater resources exploitation in western part of Aswa Catchment.

Further, a previous study of 2012 already analysed the catchment with the aim of identifying proper sites for large storages implementation. The topographical analysis of sites identified in the Aswa Multipurpose Study confirmed the following identified locations for large multipurpose storages implementation:

- Kitgum multipurpose project
- Moroto multipurpose project
- Nyimur multipurpose project.

The topography of the entire catchment was analysed in order to verify if some additional sites for large multipurpose storages could be identified. Due to the relatively flat landscape, only one additional site was identified on River Aswa, after the confluence with Agago River, just upstream from the intersection with the Gulu-Kitgum road. Figure 5.3 shows the available opportunities identified within the catchment during this assessment.

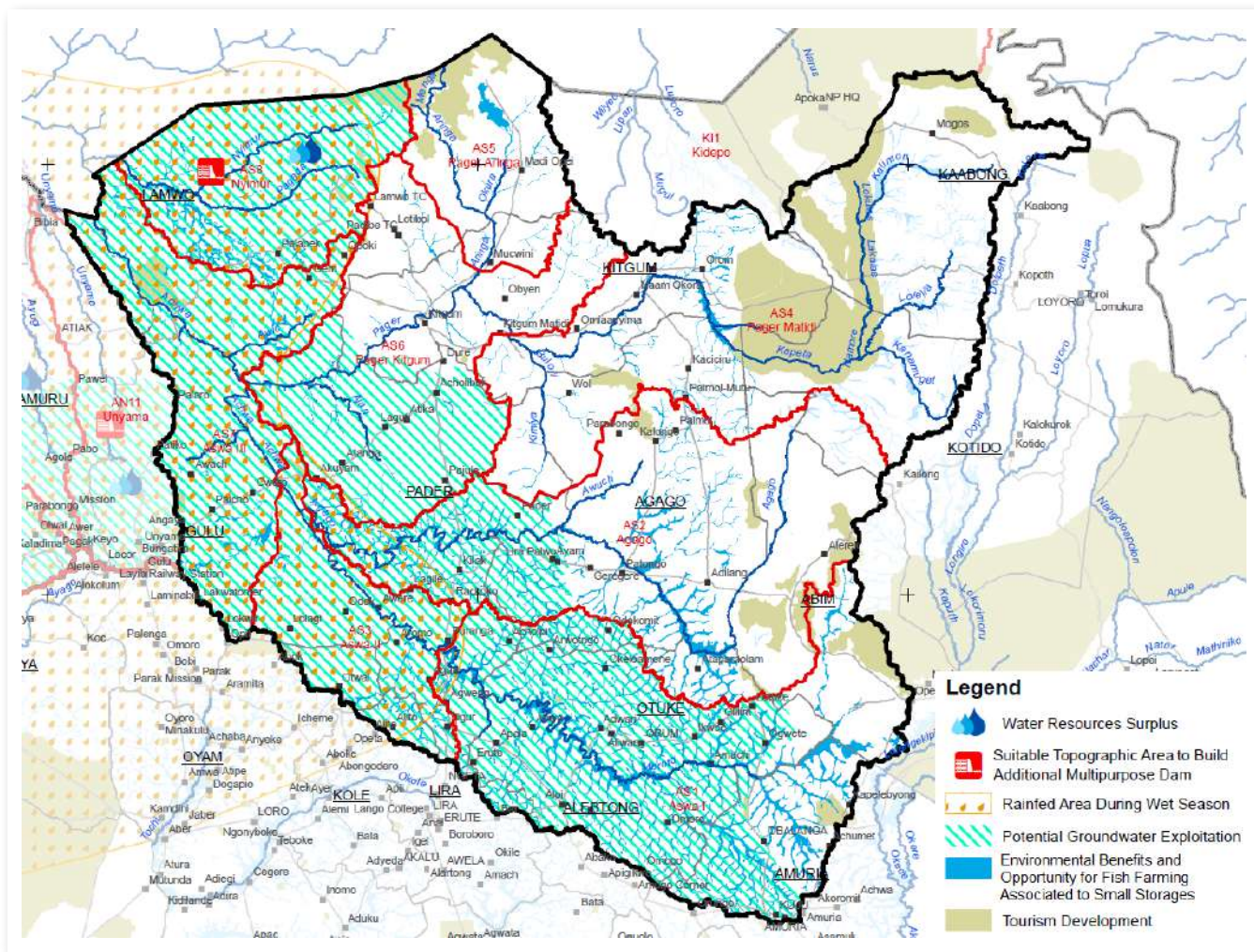

Figure 5.3: Opportunities within the catchment

5.4.2 Potential Options

Options are understood to be possible measures/interventions used to address (a) given issue(s) in a catchment, and they can be management and development in nature. Potential options were identified, primarily based on the type and criticality of issues identified and they were organised in three main categories to solve/manage issues related to:

- Availability and access to water resources
- Environmental and social sustainability and resilience
- Water governance.

The three categories of options, however, were mapped against the strategic objectives as seen in Table 5.3, Table 5.4, and Table 5.5.

Table 5.3: Potential options identified for availability and access to water resources

STRATEGIC AREA	GENERAL OBJECTIVE	POTENTIAL OPTIONS
WATER FOR PEOPLE	Universal and sustainable access to safe water supply (urban and rural)	<ul style="list-style-type: none"> -Bulk water diversion and treatment for domestic use Water treatment plants Water supply schemes Bulk water transfer schemes Community water storage facilities: <ul style="list-style-type: none"> o Tanks o Valley tanks o Small dams Large multipurpose water storage facilities: <ul style="list-style-type: none"> o Dams/Reservoirs o Large storage tanks Village point source water supply (boreholes with hand pump) Small Town and Village small scale water supply schemes (shallow or deep boreholes with motorized pump) and piped distribution Rainwater harvesting for supplemental water supply Subsurface dams for preventing excessive sub-surface outflow springs and water source protection water conservation
	Universal and sustainable access to improved sanitation and hygiene (urban and rural)	<ul style="list-style-type: none"> -Sewage collection and wastewater treatment plants in urban areas Monitoring and control of WWTP discharge in compliance with WQ standards Constructed wetlands for wastewater treatment refinement Improved sanitation in rural areas Sewage sludge management WWTP sludge management with energy/matter recovery Monitoring and control of sanitation facilities
WATER FOR PRODUCTION	Sustainable use, development and management of water resources in agriculture, livestock, fishery and forestry	<ul style="list-style-type: none"> -Bulk water diversion for large scale irrigation water supply (pumped) Bulk water diversion for small scale irrigation water supply by gravity shallow groundwater withdrawal (boreholes with treadle pumps or small pumps with low pressure pipe water distribution for small scale irrigation) Irrigation technologies for water conservation (sprinklers and drip irrigation) Water recycling and conservation technologies and best practices Afforestation & agroforestry to restore forest cover and diversity, reduce soil exposure to erosion, reduce runoff rates and increase groundwater recharge Sand mining and dredging for sedimentation control Check dams to stop gully erosion
	Sustainable use, development and management of water resources for Agro-industry, Industrial production, Oil and Gas	<ul style="list-style-type: none"> -Bulk water diversion and treatment for industrial use Water treatment plants Wastewater treatment (on site) before discharge to surface water bodies Water conservation in industrial and production processes Wastewater reuse in industrial processes Constructed wetlands for wastewater treatment refinement Sludge management and nutrient loads control Pollution prevention and control
	Sustainable use, development and management of water resources for Other Sectors (tourism, transportation, security)	<ul style="list-style-type: none"> -Reconstruction and stabilisation of degraded waterways Water transport (tourism) Drainage and collection of runoff water along road infrastructures Use of constructed wetlands for wastewater treatment in tourist facilities in national parks Pollution prevention and control

WATER FOR ENERGY	Sustainable use, development and management of water resources for renewable energy production	<ul style="list-style-type: none"> -Multipurpose water reservoirs, including HP Renewable energy from hydropower (small and micro HPP) Renewable energy recovery from sewage and WWTP sludge
-------------------------	--	---

Table 5.4: Potential Options identified for environmental and social sustainability and resilience

STRATEGIC AREA	GENERAL OBJECTIVE	POTENTIAL OPTIONS
WATER FOR ENVIRONMENT	Conservation of ecosystem services and functions	<ul style="list-style-type: none"> -Atlas of Water Resources (catch River restoration to rehabilitate hydraulic and ecologic functionality of surface water bodies Regulation on environmental flows for water bodies and wetlands use of riverine vegetation strips to slow runoff and prevent nutrient and sediment loads Groundwater recharge Reconstruction, rehabilitation and stabilization of degraded waterways (natural and artificial drains and waterways) Wetland restoration, management and regulation Pollution prevention and control water use efficiency and water conservation Prevention and control of excessive nutrient loads through integrated water and land management (agricultural best practices, control and regulation of hazardous and persistent chemicals and pollutants)
	Climate Change adaptation and building of resilient communities	<ul style="list-style-type: none"> -Flood risk and vulnerability assessment at the catchment level and mapping of flood prone areas Land use planning and limitations in flood prone areas Flood preparedness and response (flood proofing, measures flood warning and communications, relocation of activities from flood risk zones) Drought risk and vulnerability assessment at the catchment level and mapping of drought prone areas Landslide risk and vulnerability assessment at the catchment level and mapping of landslide prone areas Use of drought-enduring plants and native plants for reforestation/afforestation and gardening
	Mitigation of effects of extreme climatic events	<ul style="list-style-type: none"> -Flood control and lamination areas Flood harvesting using contour bunds to slow or stop surface runoff of rainfall Flood lamination and runoff slow down
	Green growth in the Water Sector	<ul style="list-style-type: none"> -Water efficiency Water economy Use of renewable energy sources to mitigate GHG emissions Forest management, wetland management, afforestation to increase carbon sink

Table 5.5: Potential options identified for water governance

STRATEGIC AREA	STRATEGIC OBJECTIVE	POTENTIAL OPTIONS
WATER GOVERNANCE	Equitable, participatory and accountable water governance for sustainable and Inclusive growth and development	-Water Resources monitoring network Water Resources Information System Water use efficiency Affordable technologies for CbWRM Community based management schemes for small water supply schemes and point water sources Community based management schemes for village water storage facilities (valley dams, valley tanks) Stakeholder engagement and involvement of community based organisations

5.5 Options to Scenarios

Catchment scenarios are especially useful to provide the perspective on development prospects and their impacts. Scenarios are, therefore, combinations of options. A Scenario is defined as “a combination of assumptions about the options in place (which options are possible or assumed to be implemented), external factors that influence their performance (climate, economic conditions etc.), projections or forecasts of the future (population growth rate, urbanisation rate, agricultural productivity, water use or demand rates, economic parameters, etc.) and government policy effecting either selection or performance (priority, funding, regulations, institutional arrangements etc.)” As such, combinations of options from all the strategic areas were formed to fit in the three development scenarios as defined in the sections below, with governance options as cross-cutting.

5.5.1 Scenario Definition

Three scenarios (A, B, C) were developed, each one with a different degree of infrastructure development and thus with a different level of development of economic activities related to water use.

- Scenario A is the scenario with the lower degree of infrastructure development,
- Scenario B is the intermediate one,
- Scenario C is the one with the highest degree of infrastructure development.

In all the three scenarios, according to water balance at sub-catchment level, water for people is always ensured with the construction of water storages for domestic water supply and is the investment action that has been considered to be the most urgent one. This is the reason for the choice to implement in all scenarios the large multi-purpose dams that have the function of ensuring domestic water supply to larger towns.

The improvement of water supply infrastructures, namely piped schemes and point water sources, was implemented in all scenarios, in order to reach a 100% coverage of service. In parallel with water supply, also sanitation system has to be improved in order to serve the entire population with an adequate service.

Another common feature to all scenarios is that the water for environment is always ensured.

The main differences among scenarios are mainly associated to water for production and water for energy, in particular the three scenarios have:

- A different volume of water storages which implies a different cost (construction and O&M of large reservoirs, dams, etc.) and different opportunities for associated development of productive activities
- A variable extension of irrigated area during dry season which implies different cost (construction and O&M of irrigation infrastructures) and different benefits (e.g. crops production)
- A variable number of livestock, considering the same number of grazing livestock in all scenarios (whose

number is limited by the carrying capacity of pastures) and a different number of livestock kept in stables with consequent different benefits (e.g. LTU production)

- The variable extension of ponds for aquaculture and different type of fish farming technologies (e.g. subsistence/commercial) and consequently different productivity and different benefits (e.g. fish yield)
- The same industrial water requirement since it is very small amount compared to other uses
- A different installed capacity for energy production due to the additional power (compared to the implementation of only MEMD sites that is envisaged in all scenarios) related to the implementation of large multipurpose water storages and possible peak production with storages (benefits both at water storage location and for downstream MEMD sites).

It is important to highlight the fact that part of productive activities can be performed also without the necessity of storage implementation, for example irrigation schemes can be run-of-the river schemes, as well as hydropower plants. Water storage could increase the development of productive activities and can ensure a higher reliability of the systems, which results into less dependence on climatic variability. For this reason, storages implementation is fundamental to build more resilient economic activities and to develop a society that is less dependent on rainfall seasonality and potential climatic change regarding rainfall pattern and intensity.

All the licensed and potential sites for hydropower production identified by the MEMD are supposed to be implemented in all scenarios, while some additional sites that have been identified during the analysis are associated to large multipurpose dams and are supposed to be implemented if the large storage is realised.

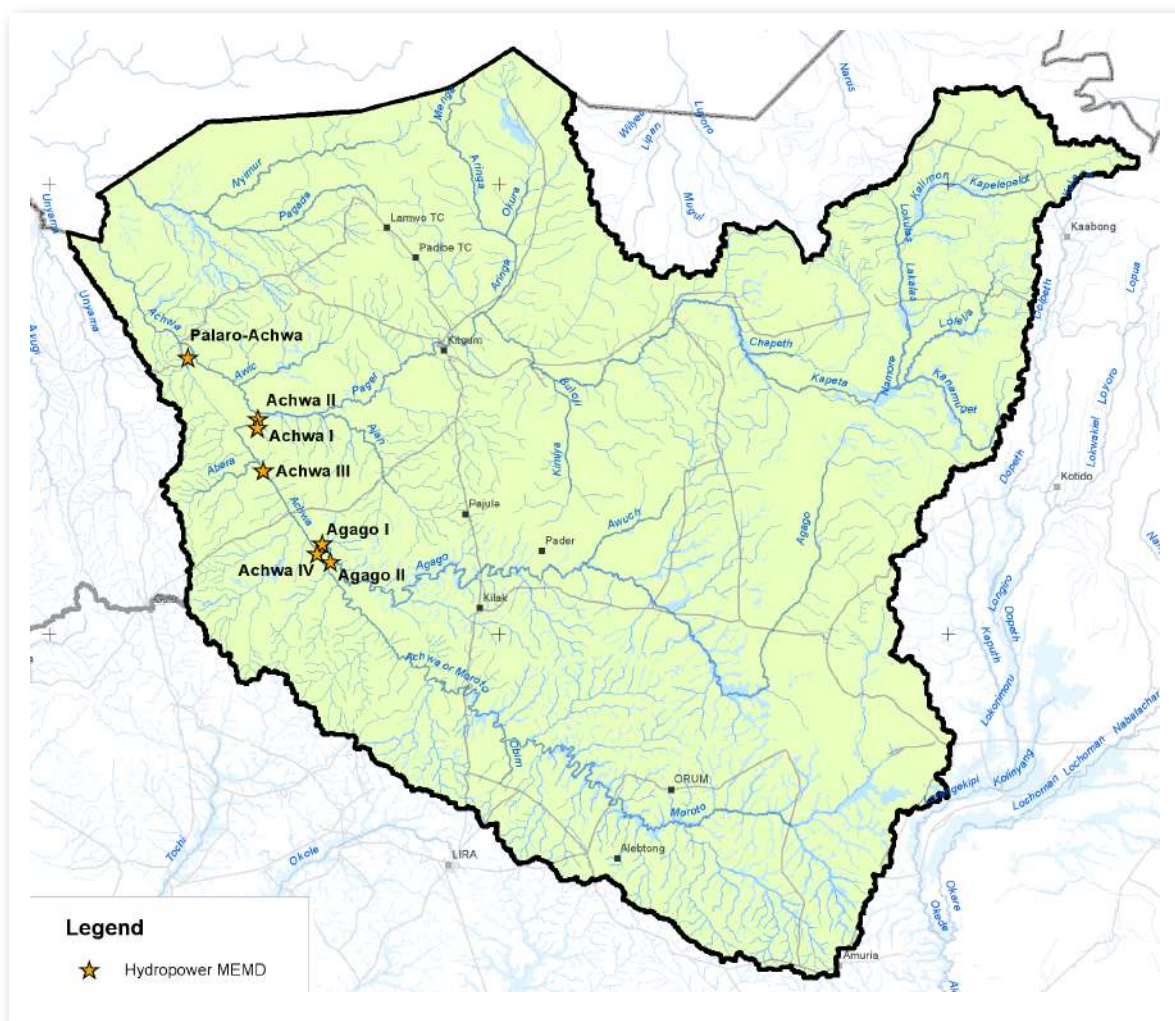

Figure 5.4: Map of MEMD sites for hydropower production foreseen in all scenarios of Aswa Catchment.

The main benefits of each scenario for the four strategic areas are listed in Table 5 4, Table 5 5, and Table 5 6 for scenarios A, B, and C respectively.

Key Elements of Scenario A

- Development of three large multipurpose storages (the Nyimur Multipurpose Project, the Kitgum Multipurpose Project and the additional dam identified along the Aswa River, just upstream the Gulu-Kitgum road)
- Net water volumes are:
 - About 2MCM for domestic water supply
 - about 38MCM for production
- Development of large irrigation schemes according to water availability- Total extension of irrigated area during the dry season will be around 33,000ha
- Facilities for livestock watering must be provided in order to avoid water pollution, erosion on the shores of water bodies and degradation of water quality- total number of 335,000LTU has been considered
- Small artificial ponds for aquaculture are envisaged for a total area of 1,150ha. These ponds can be implemented both in impounded area by dams (hypothesis of around 20%) and in permanent wetland (10% of their extent, excluding wetlands prescribed by SSSEA). Therefore, in this scenario, the small artificial pond to be constructed is around 500ha. For scenario A, it has been assumed that aquaculture is practiced at subsistence level, with a low fish productivity. The fish production can be increased taking advantages of opportunity to practice non-intensive fish farming inside wetlands, according to law limits and also inside proposed large multipurpose storages, adopting good practices in order to avoid pollution and degradation of water quality that is used for domestic water supply.

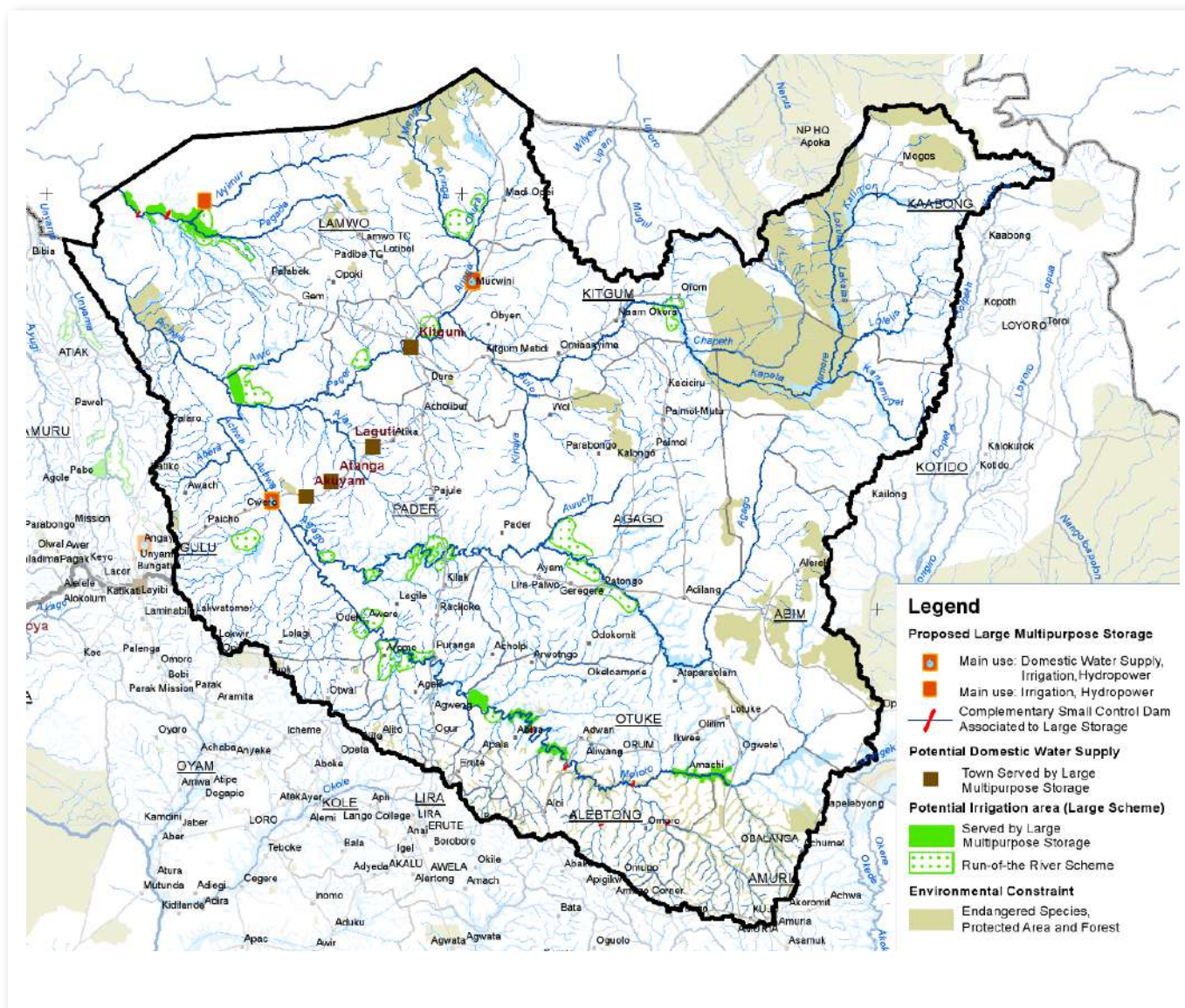

Figure 5.5: Map with main infrastructures of Scenario A of Aswa Catchment

Table 5.6: Benefits obtained in Scenario A.

Strategic area	Results/ benefits
Water for People	6.5.2 Ensured
Water for Environment	6.5.3 Ensured
Water for Production	33,000ha of irrigated area during dry season 335,000 grazing livestock (limited by carrying capacity of pastures) 1,150ha for aquaculture with low productivity (subsistence)
Water for Energy	All sites from MEMD implemented, possibility for energy peak production in sites downstream from large multipurpose dam on Aswa River, additional power at large multipurpose dam sites of 3MW

Key Elements of Scenario B

- Development of four large multipurpose storages (the Nyimur Multipurpose Project, the Kitgum Multipurpose Project, the additional dam identified along the Aswa River, just upstream the Gulu-Kitgum road and the Moroto Multipurpose Project). Moreover, the rehabilitation of existing silted storages is foreseen. Besides the implementation of large multipurpose dams, also the construction of small control dams inside wetlands, valley tanks, subsurface and sand dams is envisaged. With this scenario all type of infrastructures (multipurpose and small dams) proposed for Aswa River basin are included: the only difference with the Scenario C is then related to the number and volume of the small dams
- Net water volumes are:
 - About 2MCM for domestic water supply
 - About 93MCM for production
- Development of large irrigation schemes according to water availability. Total extension of irrigated area during the dry season will be around 41,000ha
- Facilities for livestock watering must be provided in order to avoid water pollution, erosion on the shores of water bodies and degradation of water quality. The grazing livestock number has been limited by the carrying capacity of existing pastures (335,000 LTU), but also a part of livestock kept in stable has been added, for a total number of 1,331,000 LTU
- Small artificial ponds for aquaculture are envisaged for a total area of 1,750ha. These ponds can be implemented both in impounded area by dams (hypothesis of around 20%) and in permanent wetland (10% of their extent, excluding wetlands prescribed by SSSEA). Therefore, in this scenario the small artificial pond to be constructed is around 500ha. For scenario A, it has been assumed that aquaculture is practiced at subsistence level, with a low fish productivity. The fish production can be increased taking advantages of opportunity to practice non-intensive fish farming inside wetlands, according to law limits and also inside proposed large multipurpose storages, adopting good practices in order to avoid pollution and degradation of water quality that is used for domestic water supply.



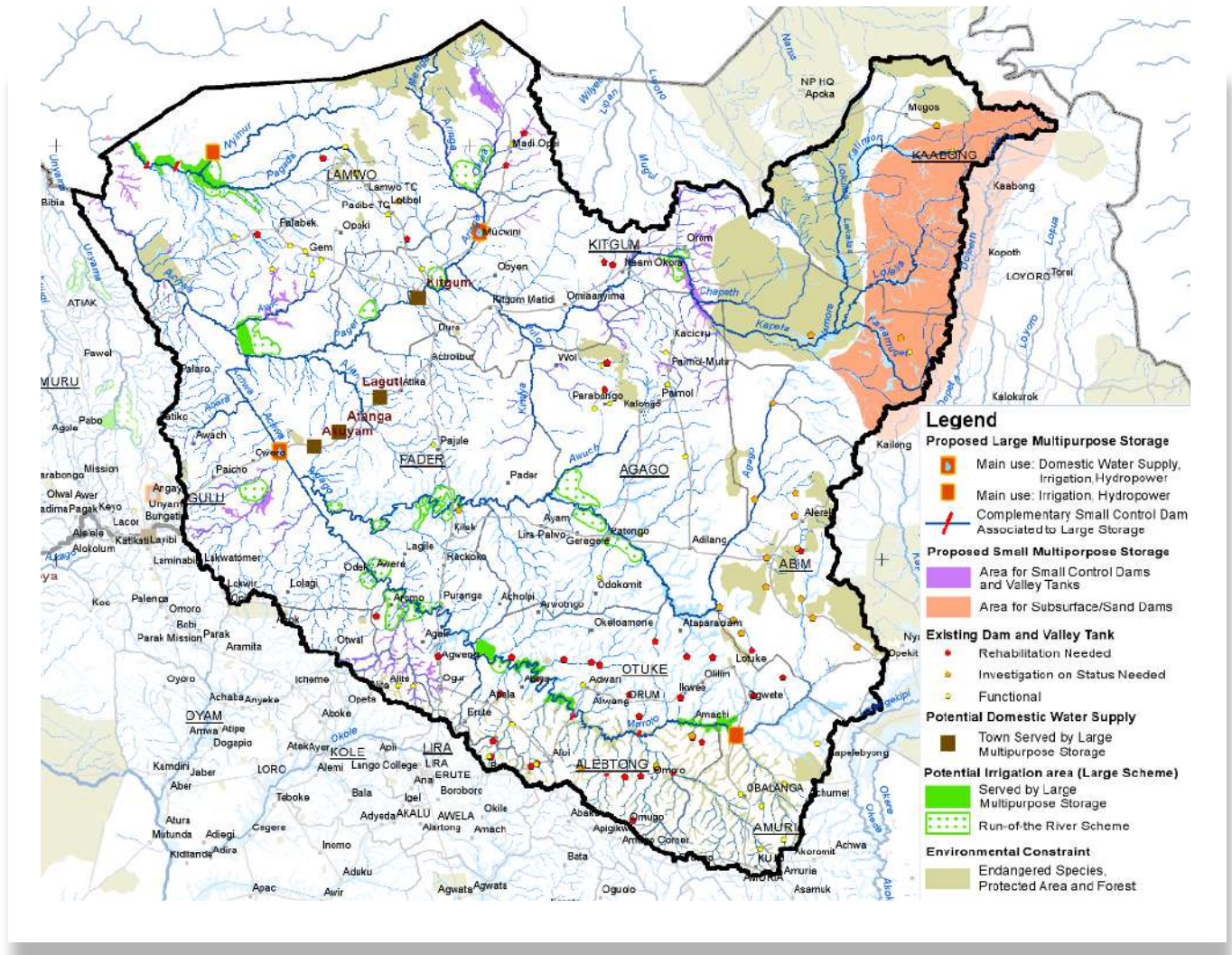

Figure 5.6: Map with main infrastructures of Scenario B of Aswa Catchment

Table 5.7: Benefits obtained in Scenario B.

Strategic area	Results/ benefits
Water for People	ensured
Water for Environment	ensured
Water for Production	41,000ha of irrigated area during dry season 1,331,000 grazing livestock (limited by carrying capacity of pastures)
	1,750ha for aquaculture with medium productivity
Water for Energy	All sites from MEMD implemented, possibility for energy peak production in sites downstream from large multipurpose dam on Aswa River, additional power at large multipurpose dam sites of 3 MW



Key Elements of Scenario C

- Development of four large multipurpose storages (the Nyimur Multipurpose Project, the Kitgum Multipurpose Project, the additional dam identified along the Aswa River, just upstream the Gulu-Kitgum road and the Moroto Multipurpose Project). Moreover, the rehabilitation of existing silted storages is foreseen. Besides the implementation of large multipurpose dams, also the construction of small control dams inside wetlands, valley tanks, subsurface and sand dams is envisaged. The number of small water storages is higher than in Scenario B, with a higher volume of stored water
- Net water volumes are:
 - About 4MCM for domestic water supply
 - About 128MCM for production.
- Development of large irrigation schemes according to water availability. Total extension of irrigated area during the dry season will be around 46,000ha
- Facilities for livestock watering must be provided in order to avoid water pollution, erosion on the shores of water bodies and degradation of water quality. The grazing livestock number has been limited by the carrying capacity of existing pastures (335,000 LTU), but also a part of livestock kept in stable has been added, for a total number of 2,328,000 LTU
- Small artificial ponds for aquaculture are envisaged for a total area of 2,350ha. These ponds can be implemented both in impounded areas by dams (hypothesis of around 20%) and in permanent wetland (10% of their extent, excluding wetlands prescribed by SSSEA). Therefore, in this scenario, the small artificial ponds to be constructed is around 900ha. For Scenario C, it has been assumed that aquaculture is practiced mainly for commercial purposes, with high fish productivity. The fish production can be increased taking advantages of opportunity to practice non-intensive fish farming inside wetlands, according to law limits and also inside proposed large multipurpose storages, adopting good practices in order to avoid pollution and degradation of water quality that is used

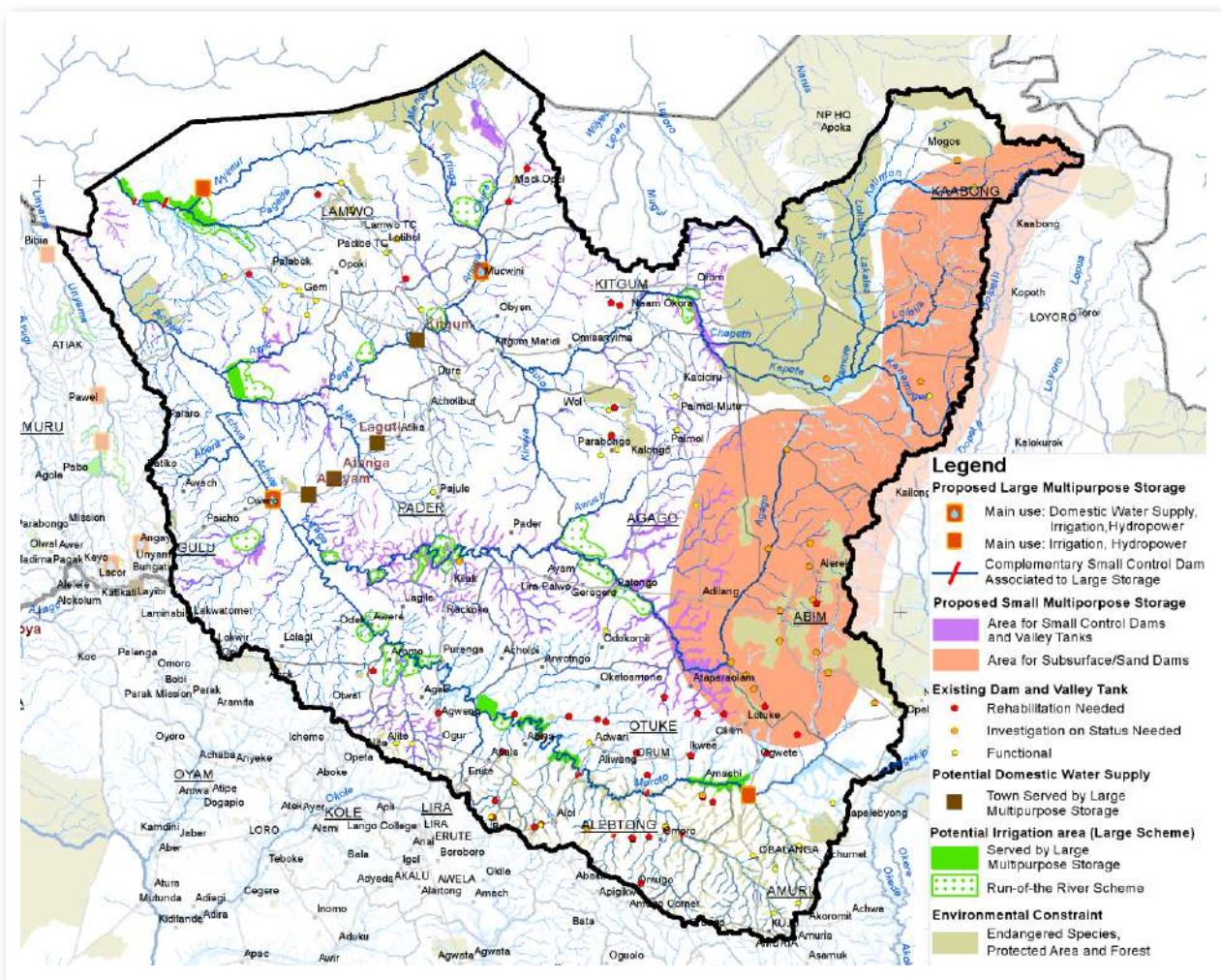

Figure 5.7: Map with main infrastructures of Scenario C of the Aswa Catchment

Table 5.8: Benefits obtained in Scenario C.

Strategic area	Results/ benefits
Water for People	ensured
Water for Environment	ensured
Water for Production	46,000ha of irrigated area during dry season 2,328,000 grazing livestock (limited by carrying capacity of pastures) 2,350ha for aquaculture with high productivity
Water for Energy	All sites from MEMD implemented, possibility for energy peak production in sites downstream from large multipurpose dam on Aswa River, additional power at large multipurpose dam sites of 3MW

5.5.2 Scenario Comparison

5.5.2.1 Approach to Cost and Benefit Estimation

After the definition of the scenarios and related benefits, a cost estimate was carried out through estimation of costs and benefits of each scenario corresponding to a set of investment and management actions, based on the data and knowledge derived from similar initiatives in Uganda.

The identified scenarios include both general actions that are common among scenarios (e.g. actions for governance), and set of specific actions that characterised each scenario. Actions might be related to construction of infrastructures (domestic water supply network, sanitation system, storages for one or more purposes, fish ponds, etc.) or they are referred to implementation of actions on water governance, information systems, capacity building, etc.

The scenarios analysis is based on the output of the water resources assessment, with identification of issues, criticalities and opportunities in the Aswa Catchment. The cost and benefit analysis is conducted by evaluating for each option, the capital costs, operational and maintenance cost, as well as benefits. In some cases, the management actions might be directly related to the costs for design, construction, and O&M of all the infrastructures already described, but for mostly, implementation costs are estimated on the basis of personnel, consultants, stakeholders' meetings/conferences/ workshops and, if needed, also equipment.

Pre-feasibility costs were typically taken to be around 1.5% of capital costs and feasibility phase about 3%. Design and construction supervision costs can be at 10%. Therefore, for the proposed infrastructures, the overall costs for personnel, consultants and meetings were taken to be 14.5% of capital costs.

5.5.2.2 Multi-Criteria Analysis

Multi-criteria analysis (MCA) establishes preferences between scenarios by reference to an explicit set of objectives identified, and for which were established measurable criteria/indicator to assess the extent to which the objectives have been achieved.

The weighted average method was the proposed method. Where it is possible to describe the consequences of a set of scenarios in terms of a single set of characteristics, their relative merits are expressed in numeric form, for instance ranging from zero for very unfavourable characteristics to 100 for very favourable ones.

Using the weighted-average method, a table is set up where each competing scenario is listed and its scores against each characteristic are tabulated. The scoring rule for each characteristic is the way in which the facts about a scenario are converted into its merit score. Indicator/parameters can be mathematical, like a proportional relationship between cost-benefit ratio or could use indicators and the related score, or they can be based on qualitative considerations or expert judgement. Each characteristic corresponds to a criterion, and its scoring rule corresponds to the way the decision-makers want that criterion to be applied.

After these steps, the analysis is simple arithmetic: for each scenario an overall merit score is calculated as the weighted average of its scores under the different criteria. At the end, a table with a ranking representing the results of the multi-criteria analysis could easily represent the prioritisation of the scenarios.

Multi-criteria approach used to compare alternative/specific sets of options (i.e. scenario) includes economic, social, environmental, and institutional factors.

Table 5.9 below shows selected NB-DSS indicators, their group and their brief description. The values of these indicators were calculated through the Mike Basin scenario model and then considered in MCA. It should be noted that urban water supply and aquaculture demand were not used as criteria to differentiate the scenarios since they are always satisfied in each scenario.

Table 5.9: NB-DSS indicators used for scenario evaluation

Indicator	Group	Description
Extent of irrigation area (Ha)	Social	Sum of the area irrigated in catchment (rather than equivalent irrigation area for different sub-catchment)
Livestock (LTU)	Social	Number of LTU
Energy production (MW)	Economic	Hydro Power Plant capacity
Extent of (increased) wetlands (Ha)	Environmental	Extent of impounded area behind large dams/ small control dams realized
Ecological stress	Environmental	Qualitative considerations based on expert judgement (scale from 0-3) taking into account number of large dam/control dam realized in each scenario
Wet flow duration	Environmental	Calculated as ratio between total storage volume of large dam/small control dams and water resource in dry semester
Flood plain inundation reduction	Environmental	Calculated as ratio between number of large dam/control dam realized in each scenario and total number planned in scenario C
Evaporation loss in dams (MCM/year)	Environmental	Yearly evaporation from storage dams



The economic benefit-cost ratio for each scenario (CBA) was added as additional indicator; it was not calculated through the Mike Basin model but using an external spreadsheet.

The institutional factor was added in MCA based on expert judgement: qualitative considerations were made taking into account initial difficulties due to lack of water policy which have inter-sectoral linkage, presumable lack of experience particularly at the initial stage in IWRM approach (e.g. management of potential conflicts to water use of large multipurpose dam etc.).

On the other hand, an improved skill and efficiency, which can be acquired in medium-long time, have been considered. This factor was included in final step of MCA when final score was calculated.

Selected criteria/indicator must be weighted in order to reflect their relative importance to the decisions. The weights were defined taking into account the relevance of each indicator from three different viewpoints: economic, environmental and social factor.

Table 5.10: Criteria weighting used for scenario evaluation

Indicator	Relative weighting of indicator for different factor		
	Economic	Social	Environmental
Ecological stress	10	5	40
Evaporation loss in dams	5	0	10
Wet flow duration	5	5	10
Extent of irrigation area	0	25	0
Extent of (increased) wetlands	5	10	30
Livestock	0	25	0
Energy production	5	10	10
Benefit-Cost	60	5	0
Floodplain inundation reduction	10	15	0
Sum of weights	100	100	100



5.5.2.3 Results and Final Considerations

Table 5.11 to Table 5.16 below summarise results/benefits obtained in three different scenarios.

Table 5.11: Net volume of water storage for different scenarios

Net volume of water storage	Scenario A	Scenario B	Scenario C
For domestic water supply (MCM)	2	2	4
For production (MCM)	38	93	128

Table 5.12: Benefits for the different scenarios.

Strategic area	Results/ benefits	Scenario A	Scenario B	Scenario C
Water for People	demand satisfied	100%	100%	100%
Water for Environment	requirements satisfied	ensured	ensured	ensured
Water for Production	Ha of irrigated area during dry season	33,000	41,000	46,000
	livestock number	335,000	1,331,000	2,328,000
	ha for aquaculture productivity	1,150	1,750	2,350
Water for Energy	energy peak production additional power at large multipurpose dam sites	yes 3 MW	yes 3 MW	yes 3 MW



The comparison from the economic point of view among scenario A, B, and C can be conducted calculating the ratio between annual benefits and the sum of annual O&M costs and capital costs. Because these latter values are referred to the construction of infrastructure, a time framework must be defined: in Table 5.13, 25 years are chosen but it has to be noted that the scenarios with the highest Benefit/Cost ratio does not vary when this duration changes.

Table 5.13 summarises the costs for each scenario related to storages (dams, livestock facilities and aquaculture ponds), distribution networks for people, irrigation and industry and sanitation systems.

Table 5 13: Capital Cost (Million US dollars) estimation for each scenario for the Aswa Catchment.

Scenario	Dam	Urban WS & SAN	Rural WS & SAN	Irrigation Dry	Livestock	Aquaculture	Industry	TOTAL
A	19	261	589	78	16	50	38	1,050
B	47			97	61	58		1,151
C	67			111	107	89		1,260

Table 5.14: Results Benefit Cost ratio (Million US dollars) of each scenario for the Aswa Catchment.

Scenario	Capital costs	O&M costs	Benefits	B/C
A	1,050	90	180	1.36
B	1,151	90	195	1.43
C	1,260	90	211	1.50

For the Aswa catchment, the Scenario C is the favourable, according to the Cost Benefit Analysis (CBA) of the investment options.

To evaluate and compare three proposed scenarios, MCA analysis has been applied to the Aswa Catchment. Table below shows the values of selected indicator calculated through the Mike Basin model and CBA.



Table 5.15: Indicator values calculated for the scenarios of the Aswa Catchment

Indicator	Group	SCENARIO		
		A	B	C
Extent of irrigation area (Ha)	Social	134,705	143,579	150,684
Livestock (LTU)	Social	334,517	1,331,379	2,328,241
Energy production (MW)	Economic	0.35	0.35	0.35
Extent of (increased) wetlands (Ha)	Environmental	253	1,320	3,673
Ecological stress	Environmental	1.00	1.00	1.00
Wet flow duration (%)	Environmental	20	44	63
Floodplain inundation reduction	Environmental	0.01	0.29	1.00
Evaporation loss in dams (MCM/year)	Environmental	7	29	36
Benefit/Cost	Economic	1.36	1.43	1.50

In all scenarios, the values of ecological stress and the energy production are the same, namely: 1 and 0.35. Therefore, the indicators were not used as criteria to differentiate the scenarios.

In order to compare all indicators, they were normalised: using the "unit-vector" method, one of the techniques included in NB-DSS, the values of different indicators were scaled to the range between zero and one. For each scenario, normalised values of indicators and weights were multiplied, added together and divided by 100 to obtain a score and rank for each scenario.

At this stage, in MCA evaluation, an additional "institutional factor" was included. This factor has been evaluated (range values from zero to one) based on expert judgement, with reference to methodology employed. To calculate final score, the economic, social and environmental factors were considered with the same weight, namely 30%, institutional factor was considered having a weight equal to 10%. Table below shows results obtained in term of scores and ranking for each scenario.

Table 5.16: Scenario score and ranks assessment from different factors

Scenario	Scenario score and ranks assessment from different factors								
	Economics		Environmental		Social		Institutional		Final score
	Score	Ranks	Score	Ranks	Score	Ranks	Score	Ranks	
	30%		30%		30%		10%		
A	0.39	3	0.13	3	0.21	3	0	3	0.22
B	0.44	2	0.20	2	0.40	2	0.5	2	0.36
C	0.56	1	0.38	1	0.68	1	1	1	0.59

The MCA analysis shows that Scenario C has a highest value of final score. This scenario is, therefore, considered "best scenario" to be implemented. Scenario C is the scenario having a highest degree of development for the sub-catchments in term of extent of irrigated area during dry season, number of livestock (LTU) grazing and water storage obtained through multipurpose dam construction. The "best" scenario was also chosen by the stakeholders during the capacity building held in Gulu in June 2016.

The benefits arising from implementation of several multipurpose dams are obviously high and countless, but at the same time, also the costs involved will be high. An important recommendation which may be done is to consider that the multipurpose dams will be carried out in short, medium or long time taking into account a prioritisation of interventions (e.g. multipurpose dam for urban water supply of Kitgum have priority): in this way it will be possible to plan and efficiently manage the available financial resources. The prioritisation of interventions and sequenced investments, up to the year 2040, was developed and presented in the sections that follow.



This section of the report presents the agreed investments in infrastructure and various water management interventions and actions meant to help resolve conflict, conserve and protect natural resources, and ensure equitable access to and use of water resources within the catchment. These actions are sequenced and prioritised up the implementation year 2040 and this forms the main body of the Aswa Catchment Management Plan. It is important to note that some actions that are common at the WMZ level are presented and discussed in the Upper Nile WMZ strategy and action plan. While many investment and management actions in this plan are common to all the scenarios discussed in the previous sections, the actions that are directly related to the best ranked scenario; Scenario C are:

- Development of four large multipurpose storages (dam higher than 10m)
- Development of large irrigation schemes linked to the implementation of the large multipurpose dams
- Rehabilitation of existing silted storages
- Construction of small control dams inside wetlands
- Construction of subsurface and sand dams in Karamoja region
- Adequate facilities for 2,330,000 LTU watering provided in order to avoid water pollution, erosion on the shores of water bodies and degradation of water quality
- Small artificial ponds for aquaculture (with different extend for each scenario), considering that a part of aquaculture can be practiced in wetlands and multipurpose storages
- Hydropower production linked to the multipurpose storages construction.

Management and investment actions were organised into 10 programme areas, "A programme being defined as a group of related projects managed in a coordinated way to obtain benefits and control not available from managing them individually. Programmes may include elements of related work outside of the scope of the discrete projects in the programme."¹ These programmes are:

- Programme 1: Geo-database and GIS Atlas
- Programme 2: Information Management System
- Programme 3: Water Resource Monitoring
- Programme 4: Water Resource Knowledge Base
- Programme 5: Water Resource Planning and Regulation System
- Programme 6: Water Sector Infrastructure and Facilities
- Programme 7: Multipurpose Water Storage Facilities
- Programme 8: Integrated Water and Land Management
- Programme 9: Stakeholder Engagement and Participatory IWRM
- Programme 10: Technical Capacity Building.



The detailed actions in each programme are presented for the general investment and management actions; those that are common to the whole catchment, and to those that are specific in terms of areas as presented in the sections below:

1 Source: Project Management Institute Glossary <http://www.pmgloss.com/about/>

6.1 General/Common Investment and Management Actions

Having organised the actions into 10 programmes as discussed in the previous section of this report, the detailed implementation actions are presented for each programme in the table below:

Table 6.1: Common Investment and Management actions

Program 1: Geo-database and GIS Atlas			
Create a GIS infrastructure to support data storage, elaboration, exchange, and information management of ASWA Catchment. Develop technical guidelines, protocols and specifications for GIS-database population and management of spatial information, including management of metadata of ASWA Catchment. Create and implement a web-GIS database for publication of relevant information on water resources, water permits and water source protection. Develop and implement a comprehensive GIS database of areas with integrated land and water management measures in the ASWA catchment level, including: reforestation / afforestation, river corridors and ecologic corridors, wetland restoration and protection, riverbanks and aquatic ecosystem restoration, water scenic landscape protection, and protected areas.			
Programme Leader	SUB-PROGRAM	Support Institutions	Action to be implemented
DWRM	GIS Infrastructure of ASWA Catchment	Upper Nile WMZ, UBOS, NPA, Districts	Establish and maintain a GIS based knowledge and information management system for the ASWA catchment
DWRM		Upper Nile WMZ, Districts	Establish and maintain a Web-GIS database of water resources, water permits, water source protection
DWRM		Upper Nile WMZ, Districts	Establish and maintain a Web-GIS database of areas with integrated land and water management measures
Programme 2: Information Management System			
Collect, access, analyse and share a wide range of information for the purposes of evaluating water resources and operational management. Establish and maintain a GIS based Inventory of Water Discharge Points, existing and planned sanitation facilities (sewerage and WWTPs) in urban areas, Water Permits on water bodies that are used for domestic/livelihood water supply, water for production facilities of Production, Industrial and Agricultural Sectors and hydropower plants (existing and planned). Create a GIS based inventory of water bodies in Catchment, based on the assessment of their hydrological, geo-morphological and ecological state (SW and GW bodies).			
Programme Leader	SUB-PROGRAM	Support Institutions	Action to be implemented
Upper Nile WMZ	Upper Nile WMZ Information Management System on Water Bodies	DWRM, DWD, DEA, NEMA, NFA, Districts	Collection, storage, elaboration and management of integrated data on water resources in the ASWA catchment
Upper Nile WMZ		DWRM, DWD, DEA, NEMA, NFA, Districts	Create a GIS based inventory of water bodies, based on the assessment of their hydrological, geo-morphological and ecological state (SW and GW bodies)
Upper Nile WMZ	Upper Nile WMZ Information Management System on Water Supply and Sanitation facilities	DWD, NWSC, Districts	Create a databank of WS and establish a mechanism for sharing information produced and elaborated by WS scheme operators (public and private) with other involved institutions in formats compatible with the national standards
Upper Nile WMZ		DWD, NWSC, Districts	Establish and maintain a GIS based inventory of Water Permits on water bodies that are used for domestic/livelihood water supply

Upper Nile WMZ	Upper Nile WMZ Information Management System on Water Supply and Sanitation facilities	DWD, NWSC, Districts	Establish and maintain a GIS based Inventory of Water Discharge Points (from public and private facilities or infrastructures) to the surface water bodies
Upper Nile WMZ	Upper Nile WMZ Information Management System on Water for Production Facilities	DWD, NWSC, Districts	Develop a GIS based inventory of existing and planned sanitation facilities (sewerage and WWTPs) in urban areas
Upper Nile WMZ	Upper Nile WMZ Information Management System on Water for Production Facilities	MAAIF, MEMD, MIT, Districts	Create a GIS based inventory of water for production facilities of Industrial Sectors, Agricultural Sectors and production for Other Sectors
Upper Nile WMZ	Upper Nile WMZ Information Management System on Water for Production Facilities	MAAIF, MEMD, MIT, Districts	Create a GIS based inventory of hydropower plants (existing and planned)

Programme 3: Water Resource Monitoring

Collect, access, analyse and share a wide range of information for the purposes of monitoring water resources and operational management. Expand and upgrade the hydro-meteorological monitoring network, hydrogeological monitoring system and WQ monitoring system. Develop an Environmental Monitoring Program on water bodies (SW and GW) to determine their ecological state. Training activities of Catchment/WMZ technical staff by Consultants (Hydrologist and Environmental expert), implementation of maps, Capacity building organization and stakeholder engagement at local/community level, will be developed in 8 year. Two training activities/technical support to Catchment/WMZ staff are foreseen per year: 2 Consultants to assist 3 technical employees, duration of 10 hours. Total cost include also additional 10 hours/training of Catchment/WMZ staff to train, coordinate and assist technical local staff (e.g. employees of local offices, local technicians etc.). One Stakeholder meeting is foreseen, every four years.

Programme Leader	SUB-PROGRAM	Support Institutions	Action to be implemented
Upper Nile WMZ	Upper Nile WMZ Water Resources Monitoring	DWRM, Districts, NEMA, DEA, UNMA	Expand and upgrade the hydro-meteorological monitoring network i.e. rehabilitation and upgrading of existing hydro-meteorological monitoring stations
Upper Nile WMZ		DWRM, Districts, NEMA, DEA, UNMA	Rehabilitation and upgrading of existing GW and hydrogeological monitoring system, the WQ monitoring network and laboratory facilities for surface and groundwater bodies
Upper Nile WMZ		DWRM, Districts, NEMA, DEA, UNMA	Develop and implement a multi-year Programme for Environmental Monitoring of water bodies (SW and GW) to determine the baseline ecological state and evolution trend over time

Programme 4: Water Resource Knowledge Base

Implement and maintain a comprehensive knowledge base on Water Resources and Water Resources management through the achieve of reference documents and information (paper and digital document) and implementation of GIS Atlas and Web-GIS Database on Water Resources and on Water Infrastructure and Facilities (existing and planned).

Programme Leader	SUB-PROGRAM	Support Institutions	Action to be implemented
------------------	-------------	----------------------	--------------------------

Upper Nile WMZ	Improve and expand the knowledge base on Water Resources	DWRM, DWD, Districts, NEMA, DEA, UNMA	Develop detailed hydrogeological studies on aquifers and subsurface groundwater potential resources; evaluation of potential for groundwater recharge (Managed Water Recharge MAR), GIS database and water balance
Upper Nile WMZ		DWRM, DWD, Districts, NEMA, DEA, UNMA	Develop a Flood Risk assessment in the Catchment considering flood events with different return periods (2, 10, 20, 100, 200 years) for the main rivers, including GIS mapping of flood prone areas and related vulnerability of population and assets
Upper Nile WMZ	Improve and expand the knowledge base on Water Resources	DWRM, DWD, Districts, NEMA, DEA, UNMA	Develop a Drought Risk assessment considering drought events with different return periods, including GIS mapping of drought prone areas and related vulnerability of population and assets and ecosystems
Upper Nile WMZ		DWRM, DWD, Districts, NEMA, DEA, UNMA	Develop and implement a comprehensive GIS database of facilities with approved/regulated environmental flows and reserve including: dams, water abstraction facilities on rivers, hydraulic works, regulated wetlands
Upper Nile WMZ		DWRM, DWD, Districts, NEMA, DEA, UNMA	Create and maintain a comprehensive library and archive of reference documents (paper and digital documents) related to water resources management in the ASWA catchment, including: research and studies on water resources, cartography, database and GIS, field research and monitoring data
Upper Nile WMZ		DWRM, DWD, Districts, NEMA, DEA, UNMA	Create and implement the GIS database of Wetlands, updating the baseline on wetland status and values, in line with the National Wetland Strategy and proceeding from District Wetland Inventories
Upper Nile WMZ	Improve and expand the knowledge base on Water Resources	DWRM, DWD, Districts, NEMA, DEA, UNMA	Create a GIS based inventory of vulnerable water bodies, based on the assessment of the vulnerability assessment (SW and GW bodies). Create a real-time data sharing web-database of meteo-climatic and hydrological information to enable hydrologic drought/flood prediction and warning systems, including regular publication of bulletins and reports



Upper Nile WMZ	Improve and expand the knowledge base on Water Infrastructure and Facilities	DWD, NWSC, Districts	Create and maintain a GIS based Inventory of water supply and sanitation service coverage (population served, urban and rural areas covered)
Upper Nile WMZ		DWD, NWSC, Districts	Create and maintain a GIS based Inventory of water supply and sanitation facilities (sources of water, facilities by type, distribution systems, sewerage networks, WWTPs, efficiency levels, performance of operators, etc.)
Upper Nile WMZ		DWD, NWSC, Districts	Create and maintain a GIS based Inventory of water supply projects for water supply (planned, pipeline, under development and completed projects)
Upper Nile WMZ		DWD, NWSC, Districts	Create and maintain a GIS based Inventory of water for production supply coverage (population served, uses)
Upper Nile WMZ		DWD, NWSC, Districts	Create and maintain a GIS based Inventory of water for production facilities (sources of water, facilities by type, uses by type, WFP storage capacity, performance of operators, etc.) including Irrigation water supply, Live-stock watering facilities, Aquaculture, Other productive uses
Upper Nile WMZ		DWD, NWSC, Districts	Create and maintain a GIS based Inventory of industrial water supply facilities (sources of water, facilities by type, uses by type, WWTP capacity, performance of operators, etc.) and industrial water supply projects ((planned, pipeline, under development and completed projects)
Upper Nile WMZ		DWD, NWSC, Districts	Create and maintain a GIS based Inventory of Oil and Gas water facilities (sources of water - SW and GW, facilities by type, uses by type, WWTP capacity) and Oil and Gas Water Facilities projects (planned, pipeline, under development and completed projects)
Upper Nile WMZ		DWD, NWSC, Districts	Create and maintain a GIS based Inventory of hydropower facilities (sources of water, facilities by type, installed capacity) and Hydropower projects (planned, pipeline, under development and completed projects)
Upper Nile WMZ		DWD, NWSC, Districts	Create and maintain a GIS based Inventory of multipurpose facilities (sources of water, facilities by type, uses by type, storage capacity) and projects (planned, pipeline, under development and completed projects)
Upper Nile WMZ		DWD, NWSC, Districts	Create and maintain a GIS based Inventory hydraulic works, sediment control interventions, drainage facilities
Upper Nile WMZ	Improve and expand the knowledge base on Water Infrastructure and Facilities	DWD, NWSC, Districts	Develop a GIS based detailed land use mapping of urban areas and agglomerates aimed at developing a Master Plan for design, construction and operationalization of sewerage systems and WWTPs in major towns, small towns and RDCs

Upper Nile WMZ	Improve and expand the knowledge base on Water Infrastructure and Facilities	DWD, NWSC, Districts	Develop a GIS based detailed land use mapping of industrial areas and related WFP facilities aimed at developing a Master Plan for design, construction and operationalization of Industrial Water for Production Facilities based on industrial water demand
Upper Nile WMZ		DWD, NWSC, Districts	Develop a GIS based detailed land use mapping of road infrastructure aimed at developing a Programme for Road Infrastructure drainage and stormwater management
Upper Nile WMZ		DWD, NWSC, Districts	Define and operationalize a Technical Standard for management of hydropower plants associated with reservoirs to accommodate the peak energy demand (pumped hydro-electric storage)
Upper Nile WMZ	Improve and expand the knowledge base on Water Infrastructure and Facilities	DWD, NWSC, Districts	Develop a GIS based detailed mapping of road infrastructures aimed at preparing a Master Plan for design, construction and operationalization of an adequate drainage systems along main roads, including culverts
Upper Nile WMZ	Integrated Knowledge for Management of Water Resources	DWRM, DWD, DEA, NEMA, NFA, MAAIF, MEMD, MIT, Districts	Develop a GIS inventory of pollution sources (point and non-point sources) aimed at developing an Integrated Pollution Prevention Programme to protect and conserve water resources
Upper Nile WMZ		DWRM, DWD, DEA, NEMA, NFA, MAAIF, MEMD, MIT, Districts	Develop a GIS Inventory and Atlas of pollution and sediment loads (from point and non-point sources) aimed at developing an Integrated Pollution Prevention and Sediment Management Programme
Upper Nile WMZ		DWRM, DWD, DEA, NEMA, NFA, MAAIF, MEMD, MIT, Districts	Develop a GIS Inventory and Atlas of degraded areas and areas at risk of erosion (mountain slopes, riverbanks, linear infrastructures) aimed at developing an Integrated Land & Water Management Programme
Upper Nile WMZ		DWRM, DWD, DEA, NEMA, NFA, MAAIF, MEMD, MIT, Districts	Develop a GIS based detailed land use mapping of scenic water landscapes aimed at developing a Programme for touristic valorisation of water bodies
Upper Nile WMZ	Knowledge management and exchange	DWRM, DWD, Districts, CMO, MSE, MLG	Publication of a comprehensive GIS Atlas of Water Resources (web-GIS) including surface water bodies, groundwater bodies, water quality and health of water bodies, water related ecosystems

Programme 5: Water Resource Planning and Regulation System

Establish and maintain a Upper Nile WMZ Modelling Unit, improve and expand the water permit management system in the WMZ/ASWA Catchment. Establish and operationalize the Catchment Management Organizations in the Upper Nile WMZ; develop Water Sector funding mechanisms for decentralized IWRM implementation at the WMZ and catchment levels. Develop water source protection plans and promote integrated pollution prevention and control in the Upper Nile WMZ.

Programme Leader	SUB-PROGRAM	Support Institutions	Action to be implemented
------------------	-------------	----------------------	--------------------------

Upper Nile WMZ	Water Resources Planning and Regulation System	DWRM, DWD, DEA,WESWG, CMO	Set up a modelling unit coordinated with the central DWRM Hydrologic Department. Develop technical guidelines and specifications for WR modelling and scenario development and analysis at the WMZ and catchment levels
Upper Nile WMZ	Water Resources Planning and Regulation System	DWRM, DWD, DEA,WESWG, CMO	Develop and implement a multi-year Water Resources Inspection and Control Programme, harmonized and coordinated with the central DWRM operational programmes
Upper Nile WMZ		DWRM, DWD, DEA,WESWG, CMO	Development of targeted Water Sector funding mechanisms (proposed fee of 3% of investment projects) for supporting decentralized IWRM implementation at the WMZ and catchment levels
Upper Nile WMZ		DWRM, DWD, DEA,WESWG, CMO	Establish a cross-sectoral coordination platform for IWRM implementation between WMZ and Regional Agencies, CMOs and Local Government at the catchment level, private sectors, including specific rules and procedures for cooperation. Develop a register of institutional competences, references, procedures, agreements
Upper Nile WMZ		DWRM, DWD, DEA,WESWG, CMO	Develop and implement water source protection plans according to the framework WSP guidelines (source-catchment level). Promote community-based management of point water sources through establishment of WSP Committees at local level (village). Develop and operationalize a technical guideline for applying disinfection technologies and practices to small water supply schemes and point sources in rural areas in case of emergency
Upper Nile WMZ		DWRM, DWD, DEA,WESWG, CMO	Develop and operationalize technical standards to implement an integrated pollution prevention and control system to protect and conserve water resources
Upper Nile WMZ		DWRM, DWD, DEA,WESWG, CMO	

Programme 6: Water Sector Infrastructure & Facilities

Ensure adequate water quality control on water supplied for domestic/household use (SW and GW sources), water supplied for production (SW and GW) for Agricultural Production and for Industrial production. Define and operationalize a Technical Standard for water for production storage facilities and infrastructure design, construction and management, including multipurpose facilities. Improve management of sludge from sewage and sanitation facilities.

Programme Leader	SUB-PROGRAM	Support Institutions	Action to be implemented
DWD	Water Supply infrastructure and service	DWRM, WSDF, TSU, UO, Districts	Develop and implement a multi-year Programme of WQ monitoring for SW and GW sources and WS schemes, in line with the National WQ strategy
DWD	Sanitation infrastructure and service	NWSC, Districts	Develop and operationalize Technical Standards for developing improved sanitation and hygiene facilities for public institutions and schools
DWD	Sanitation infrastructure and service	NWSC, Districts	Develop and operationalize a technical standard for collection, treatment and management of sludge from sewage and sanitation facilities in urban and rural areas

DWD	Water for Production facilities	DWRM, MAAIF, MEMD, MIT, OPM	Develop and implement a multi-year Programme for WQ monitoring for SW and GW sources and WFP storage facilities of Agricultural Sectors, in line with the National WQ strategy
DWD		DWRM, MAAIF, MEMD, MIT, OPM	Define and operationalize a Technical Standard for water for production storage facilities and infrastructure design, construction and management, including multipurpose facilities
DWD	Water for Production facilities	DWRM, MAAIF, MEMD, MIT, OPM	Develop and implement a multi-year Programme for WQ monitoring for SW and GW sources and WFP storage facilities of Industrial Sectors, in line with the National WQ strategy

Programme 7: Multipurpose Water Storage Facilities

Define and operationalize a Technical Standard for design, implementation and management of multipurpose water for production storage facilities, storage facilities including recreational functions and including hydropower. Establish a responsible authority for multipurpose storages integrated planning and coordination at catchment level (e.g. institutional authority which manage priority of dam's implementation); establish a responsible authority for multipurpose storage which manage and is responsible for balancing competing demands (e.g. institutional authority); establish a team responsible for efficient operation and management of multipurpose dam (e.g. technical staff, O&M guidelines).

Programme Leader	SUB-PROGRAM	Support Institutions	Action to be implemented
Multipurpose Program Unit (to be established under the MWE)	Multipurpose Water Storage Facilities	DWRM, DWD, DEA, OPM, WESWG, MEMD, MIT, MAAIF, NFA	Define and operationalize a Technical Standard for design, implementation and management of multipurpose water for production storage facilities
Multipurpose Program Unit (to be established under the MWE)		DWRM, DWD, DEA, OPM, WESWG, MEMD, MIT, MAAIF, NFA	Define and operationalize a Technical Standard for design, implementation and management of multipurpose water storage facilities including recreational functions
Multipurpose Program Unit (to be established under the MWE)		DWRM, DWD, DEA, OPM, WESWG, MEMD, MIT, MAAIF, NFA	Develop study for detail design, construction, operationalization and management of multipurpose water storage facilities including hydropower

Programme 8: Integrated Water and Land Management

Promote water efficiency practices (water conservation, reuse, recycling) in the ASWA catchment, promote irrigation water efficiency and water conservation agricultural practices, and promote optimization of water for production uses and reuse of treated wastewater for landscaping, green areas and other uses. Ensure appropriate environmental flows in water bodies, establish and maintain a water demand management system, promote integrated land and water management and enforce riverbanks protection zones. Increase preparedness to severe climate events (flood / drought).

Programme Leader	SUB-PROGRAM	Support Institutions	Action to be implemented
------------------	-------------	----------------------	--------------------------



Upper Nile WMZ	Water Efficiency	DWD, DEA, NEMA, NFA	Develop and operationalize technical guidelines to promote implementation of technologies and best practices for efficient use of water (conservation, reuse, recycling) in urban and rural areas. Develop and operationalize a technical standard for leakage detection in WS schemes and regular assessment of piped water distribution networks
Upper Nile WMZ		DWD, DEA, NEMA, NFA	Define and operationalize a Technical Standard for design, implementation and management of irrigation schemes, including provisions for water efficiency, water quality and integrated land management
Upper Nile WMZ		DWD, DEA, NEMA, NFA	Define and operationalize a set of Technical Standards for water efficiency (conservation, reuse, recycling) in Industrial Sectors based on best practices
Upper Nile WMZ		DWD, DEA, NEMA, NFA	Define and operationalize a set of Technical Standards for reuse of treated wastewater for landscaping, green areas and other uses
Upper Nile WMZ	Environmental flows and reserve management system	DWRM, DEA, CMO	Define and operationalize a set of Technical Standards for determination, implementation and management of environmental flows
Upper Nile WMZ		DWRM, DEA, CMO	Update and expand the knowledge base on water resources and maintain the water balance updated at the catchment level based on the evolution of water demand and licensed permits over time
Upper Nile WMZ	Integrated Water and Land Management	NEMA, NFA	Define and operationalize a set of Technical Guidelines for improving agricultural and forestry practices, including provisions for assessment and management of the land carrying capacity for livestock
Upper Nile WMZ		NEMA, NFA	Develop and operationalize a set of Technical Guidelines for delineating and enforcing riverbank protection zones along all the rivers of ASWA catchment
Upper Nile WMZ	Resilience to climate variability and change	DWRM, DEA, NEMA, UCC, UNMA	Develop a GIS based Flood / Drought Response and Management Plan, including regulatory and management procedures for hydraulic structures

Programme 9: Stakeholder engagement and participatory IWRM

Stakeholder engagement mechanism developed and established at the WMZ/Catchment level. Awareness raising on wise use of water resource and on waste management. Awareness raising on water efficiency in Agriculture, on water efficiency in Industry, on renewable energy potential and energy efficiency, on water for environment and management of natural resources.

Programme Leader	SUB-PROGRAM	Support Institutions	Action to be implemented
Upper Nile WMZ	Stakeholder engagement and participatory IWRM	CMO, Districts	Develop and implement a multi-year Stakeholder Engagement Programme, including specific procedures, means and tools for stakeholder consultation
Upper Nile WMZ	Awareness Raising	DWRM, DWD, DEA, CMO	Develop a multi-year Awareness Raising Programme to promote protection, conservation and efficient use of water resources, including preparation of targeted communication materials

Upper Nile WMZ	Awareness Raising	DWRM, DWD, DEA, CMO	Develop a multi-year Awareness Raising Programme on importance of waste and sludge management in the Upper Nile WMZ, including preparation of targeted communication materials
Upper Nile WMZ		DWRM, DWD, DEA, CMO	Develop a multi-year Awareness Raising Programme on importance of water efficiency in Agriculture, including preparation of targeted communication materials
Upper Nile WMZ		DWRM, DWD, DEA, CMO	Develop a multi-year Awareness Raising Programme on importance of water efficiency in Industrial processes, including preparation of targeted communication materials
Upper Nile WMZ		DWRM, DWD, DEA, CMO	Develop a multi-year Awareness Raising Programme on importance of development of renewable energy (Hydropower energy) and energy efficiency, as well as integrated land and water management, including preparation of targeted communication materials
Upper Nile WMZ		DWRM, DWD, DEA, CMO	Develop a multi-year Awareness Raising Programme on importance of sustainable development of water resources and management of natural resources ,including preparation of targeted communication materials

Programme 10: Technical Capacity Building

Training activities of Catchment/WMZ technical staff by Consultants (Hydraulic Engineer and/or hydrologist, Environmental expert, Institutional Representative), implementation of manuals, Capacity building organization and stakeholder engagement at local/community level, will be developed in 8 year. Two training activities and technical support to Catchment/WMZ staff are foreseen per year: 2 Consultants to assist 3 technical employees, duration of 15 hours. Total cost include also additional 10-15 hours of Catchment/WMZ staff to train, coordinate and assist stakeholders involved at local level (e.g. farmers, employees in industrial sectors, cattle farmers etc.). One Stakeholder meeting is foreseen every four/three years.

Programme Leader	SUB-PROGRAM	Support Institutions	Action to be implemented
------------------	-------------	----------------------	--------------------------



DWRM	Technical Capacity Building	WESWG, DWD, DEA, Upper Nile WMZ	Develop a multi-year programme of capacity building of local governments and stakeholders, to create the Enabling Environment for decentralized IWRM implementation at the WMZ and catchment levels
DWRM		WESWG, DWD, DEA, Upper Nile WMZ	Plan and provide regular training and capacity building to technical staff for enforcement of regulations at the catchment level
DWRM		WESWG, DWD, DEA, Upper Nile WMZ	Develop a multi-year Capacity Building Programme for applying disinfection technologies and practices to small water supply schemes and point sources in rural areas, including preparation of training manuals in local languages
DWRM		WESWG, DWD, DEA, Upper Nile WMZ	Develop a multi-year Capacity Building Programme for applying improved sanitation and hygiene technologies in minor urban areas and rural areas, including preparation of training manuals in local languages
DWRM		WESWG, DWD, DEA, Upper Nile WMZ	Develop a multi-year Capacity Building Programme for developing an Integrated Pollution Prevention and Control system, including preparation of training manuals in local languages
DWRM		WESWG, DWD, DEA, Upper Nile WMZ	Develop a multi-year Capacity Building Programme for applying water efficiency practices and technologies in agricultural sectors, including preparation of training manuals in local languages
DWRM		WESWG, DWD, DEA, Upper Nile WMZ	Develop a multi-year Capacity Building Programme for applying water efficiency practices and technologies in industrial sectors, including preparation of training manuals in local languages
DWRM	Technical Capacity Building	WESWG, DWD, DEA, Upper Nile WMZ	Develop a multi-year Capacity Building Programme for technical evaluation of hydropower projects and for applying the best energy efficiency practices and technologies, including preparation of training manuals
DWRM		WESWG, DWD, DEA, Upper Nile WMZ	Develop a multi-year Capacity Building Programme for determination and implementation of environmental flows and water reserves, based on best practices, including preparation of training manuals



6.2 Specific Investment and Management Actions

These are actions that are associated with specific areas and they were also organised in terms of the broader programmes under which they lie.

Table 6.2: Specific Investment and Management Actions

Programme 6: Water Sector Infrastructure and Facilities					
Expand the water supply infrastructures for full coverage of urban and rural population and increase water storage capacity for domestic water supply in areas with seasonal deficits. Rehabilitate and improve functionality of existing water for production storage facilities and develop underground water storage for production in areas with water deficit. Expand irrigation schemes (e.g. large irrigation scheme served by multi-purpose, run-of-the river schemes), improve water for production facilities in aquaculture and fishery, expand rainwater harvesting facilities and increase water for production storage capacity in areas with seasonal deficits. Improve sanitation and hygiene facilities and implement WWTP or alternative wastewater treatment method (e.g. lagoon). Develop water supply facilities using groundwater sources in areas with good potentialities for groundwater resources exploitation.					
Programme Leader	SUB-PROGRAMME	Support Institutions	Action ID	Action to be implemented	Prioritised area
DWD	Water supply infrastructure and service	DWRM, WSDF, TSU, UO, Districts	2.3.1	Develop a programme for design, construction and operationalisation of new piped water supply schemes to cover 100% of urban population	Sub-catchment of the eastern part of Aswa (Aswa I, Agago, Pager Matidi, Pager Kitgum)
DWD		DWRM, WSDF, TSU, UO, Districts	2.3.2	Develop a pre-feasibility study for design, construction and operationalization of new water storage facilities for drinking water supply in sub-catchments with water deficit	Pager Kitgum sub-catchment (main town Kitgum)
DWD		DWRM, WSDF, TSU, UO, Districts	2.3.4	Develop a detailed hydrogeological study for assessment of potential capacity for water supply from groundwater	Aswa I, Aswa II, Aswa III, Nyimur, downstream areas of Agago and Pager Kitgum sub-catchment
DWD	Water for production facilities	DWRM, MAAIF, MEMD,MIT, OPM	4.3.2	Develop and implement a GIS based Programme for rehabilitation and management of existing water for production storage facilities and infrastructure	Alebtong, Otuke, Abim, Kitgum and Lamwo District
DWD		DWRM, MAAIF, MEMD,MIT, OPM	4.3.5	Based on the detailed hydrogeological assessment of the Aswa Catchment, develop a Programme for WFP underground water storage and groundwater recharge	Higher part of Pager Matidi and Agago sub-catchment (Kaabong District)
DWD		DWRM, MAAIF, MEMD,MIT, OPM	4.3.6	Develop a pre-feasibility study for design, construction and operationalization of new irrigation schemes (Type A and B) in suitable areas	Suitable areas Aswa I, Agago and Aswa II sub-catchments
DWD		DWRM, MAAIF, MEMD,MIT, OPM	4.3.8	Define and operationalise a set of Technical Standards for developing intensive and semi-intensive aquaculture facilities, including provisions for water	Aswa I, Agago and Aswa II sub-catchments

Programme Leader	SUB-PROGRAMME	Support Institutions	Action ID	Action to be implemented	Prioritised area
				efficiency, water quality and protection of biodiversity	
DWD		DWRM, MAAIF, MEMD, MIT, OPM	4.3.3	Develop study for detail design, construction and operationalisation of new water for large production storage facilities (multipurpose) in in sub-catchments with seasonal defici	Aswa I, Aswa II, Pager-Aringa and Nyimur sub-catchment
		DWRM, MAAIF, MEMD, MIT, OPM	4.3.3	Multi-year programme for operationalisation small WFP facilities: small control dam/sand dam and valley tanks	Aswa II, Aswa III, Pager Aringa and Pager Matidi sub-catchment
DWD		DWRM, WSDF, TSU, UO, Districts	2.3.6	Develop and operationalise a technical standard for installation and operation of rainwater harvesting installations at village and household level	
DWD	Sanitation infrastructure and service	NWSC, Districts	3.3.2	Improve sanitation and hygiene facilities in rural and urban areas, mainly in the areas with highest population density in the Aswa Catchment	Kigum TC, Pader TC, the most populated areas of Agago district (including Patongo TC, Kalongo TC and Agago TC), Kole and Lira districts and most populated areas of Alebtong and Amuria districts
DWD		NWSC, Districts	3.3.2	Implementation of WWTP or alternative wastewater treatment method (e.g. lagoon)	Kitgum, Agago, Abim and Pader town

Programme 7: Multipurpose Water Storage Facilities

Promote integrated development of agro-tourism and agro-industrial processing facilities; promote integrated development of eco-tourism facilities in the Aswa Catchment.

Multipurpose Programme Unit (to be established under the MWE)	Multipurpose Water Storage Facilities	DWRM, DWD, DEA, OPM, WESWG, MEMD, MIT, MAAIF, NFA	6.3.1	Define and operationalise a set of technical standards for developing eco-tourism facilities	Protected area and Forest in Kitgum, Kaabong, Abim and Agago Districts
---	---------------------------------------	---	-------	--	--

Programme 8: Integrated Water and Land Management

Promote optimisation of water for recreation and other uses. Create a green infrastructure system to establish and protect ecologic corridors along water bodies and create a green infrastructure system in the cattle corridor in the Aswa Catchment.

Programme Leader	SUB-PROGRAMME	Support Institutions	Action ID	Action to be implemented	Prioritised area
Upper Nile WMZ	Water efficiency	DWD, DEA, NEMA, NFA	6.2.1	Define and operationalise a set of technical standards for water efficiency (conservation, reuse, recycling) for recreation and other uses based on best practices	Protected wetland area of Pager Matidi and Aswa I sub-catchment
Upper Nile WMZ	Integrated Water and Land Management	NEMA, NFA	8.3.1	Based on the updated Land Cover of NFA, develop and implement a programme for creating a green infrastructure system to protect ecosystems, ecologic corridors and natural landscapes in the water bodies	Protected wetland area (Land Cover of NFA) of Pager Matidi and Aswa I sub-catchment
Upper Nile WMZ		NEMA, NFA	8.3.2	Based on the updated land cover of NFA, develop and implement a programme for creating a green infrastructure system to protect ecosystems, ecologic corridors and natural landscapes and support livelihoods in the cattle corridor	Areas of cattle corridor (Land Cover of NFA) i.e., in Aswa I, Pager Matidi and Agago sub-catchment

Programme 10: Technical Capacity Building

Build technical capacity for wetland management, for ecosystem assessment and for determining and implementing environmental flows and water reserves. Training activities of catchment/WMZ technical staff by consultants (Hydraulic Engineer and/or hydrologist, environmental expert), implementation of manuals, capacity building organisation and stakeholder engagement at local/community level, will be developed in eight years. Two training activities and technical support to catchment/WMZ staff are foreseen per year: Two consultants to assist three technical employees, duration of 10 hours. Total cost includes also additional 10 hours of catchment/WMZ staff to train, coordinate and assist stakeholders involved at local level (e.g. local people living near protected areas, farmers, cattle farmers, etc.). One stakeholder meeting is foreseen, every four years.

DWRM	Technical capacity building	WESWG, DWD, DEA, Upper Nile WMZ	8.5.2	Develop a multi-year capacity building Programme for wetlands and aquatic ecosystems assessment, based on best practices and standards, including preparation of training manuals	Protected wetland area (Land Cover of NFA) of Pager Matidi and Aswa I sub-catchment
DWRM	Technical capacity building	WESWG, DWD, DEA, Upper Nile WMZ	8.5.3	Develop a multi-year capacity building Programme for sustainable development and management of wetlands and aquatic ecosystems, based on best practices and standards, including preparation of training manuals.	Protected wetland area (land cover of NFA) of Pager Matidi and Aswa I sub-catchment

6.3 Locations of Water Storage Infrastructure

The topography of the entire catchment was analysed in order to identify sites for large multipurpose storages implementation. Once that suitable sites from a topographical point of view were identified, hydrological characteristics of the sub-catchment were analysed at each large water storage location. The availability of water resources was assessed in order to evaluate also the hydrological feasibility of the reservoir. The conducted evaluation for potential groundwater recharge allows the theoretical identification of areas where potentiality for exploitation seems to be higher within the catchment. Further considerations are based upon information gathered from the Groundwater Mapping (DWRM, 2012).

This assessment identified 4 sites suitable to realise large dams within the Aswa Catchment. Figure 6.1 below shows the locations of the identified sites.

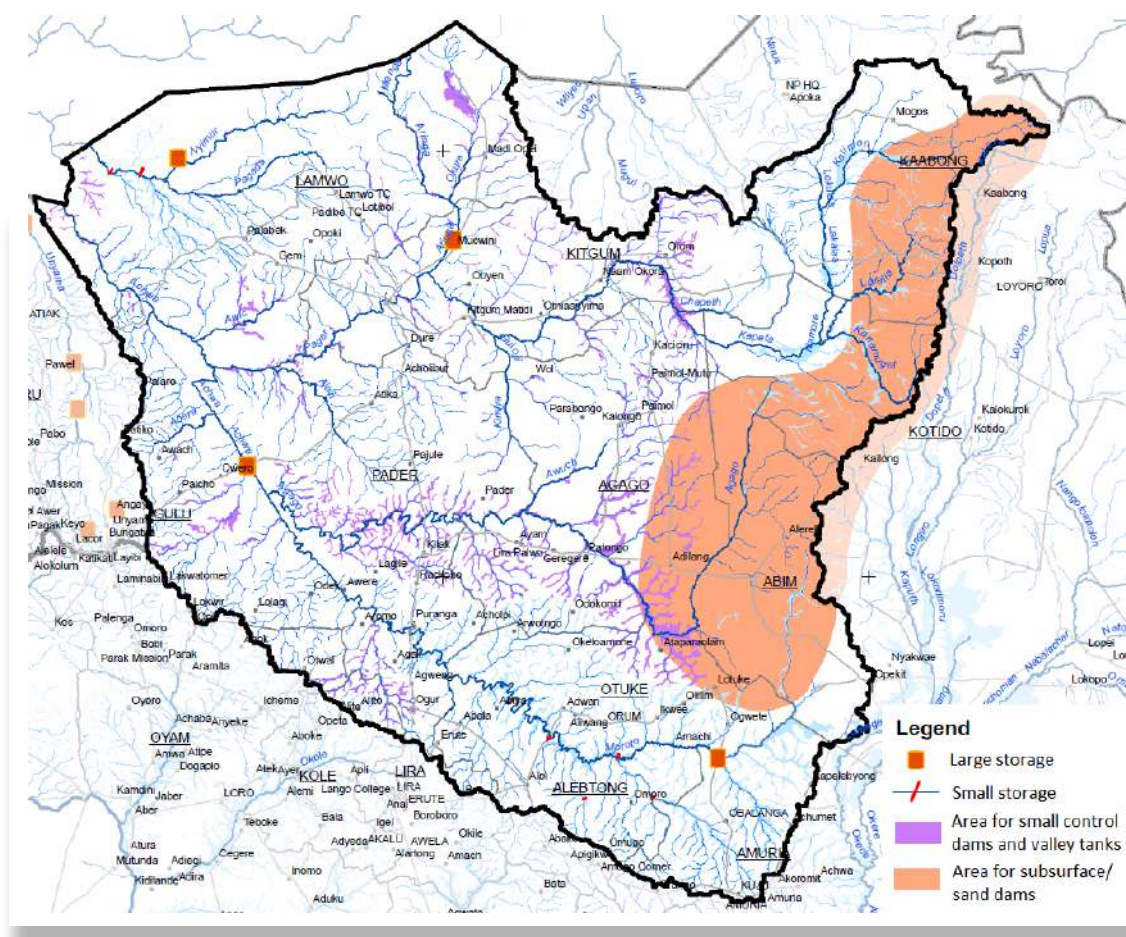

Figure 6.1: Map of potential sites for water storage implementation

Table 6.3: Locations of Water Storage Infrastructure

Name	x	y	District	Sub-county
Moroto Project	564,639	257,486	Amuria-Otuke	Obalanga-Okungur-Ogwette
ASWA II	454,229	326,135	Pader-Gulu	Angangura-Paicho
Kitgum Project	502,584	379,170	Kitgum	Mucwini
Nyimur Project	438,003	398,412	Lamwo	Palabek-Gem

According to the International Committee on Large Dams Guidelines (ICOLD), all the above listed dams are "large." This evaluation is done with reference to height and storage volume of dam. In particular, these two parameters are combined as and define the extreme of the three categories: "large" if higher than 200, "small" if lower than 20.

6.4 Pilot Areas for Groundwater Investigation and Exploitation

The analysis of hydrogeological conditions is important because groundwater is the most widely used source of water supply in rural areas due to its wider spatial distribution, perennial availability, and reasonably good quality. Groundwater is usually abstracted through boreholes, springs, shallow wells, and traditional wells. The conducted evaluation of potential groundwater recharge on the basis of a hydrological study allows to identify theoretically areas where potential for exploitation seems to be higher within the catchment. Further considerations are based upon information gathered from the Groundwater Mapping (DWRM, 2012).

The water table is quite close to the ground along the main course of the river except for the lower part after the confluence with Pager, and within the lower portion of Agago river basin. In the remaining zones of the Aswa Catchment, the groundwater levels are relatively deep and, in the eastern part, very deep. Within the catchment, the success rate is mainly between 50% and 70%, while the Karamoja region has a low value. Most of Aswa groundwater system is of good quality. Limited zones with poor water quality are along the middle course of River Aswa and in Karamoja region.

All the above mentioned parameters provide a first assessment on feasibility (from the hydrological point of view, in terms of cost, etc.) of groundwater exploitation. Positive and negative aspects related to them are considered to identify sub-catchment where potentially optimal and critical for wells withdrawal: these sub-catchments are represented with darker colour in the following image.

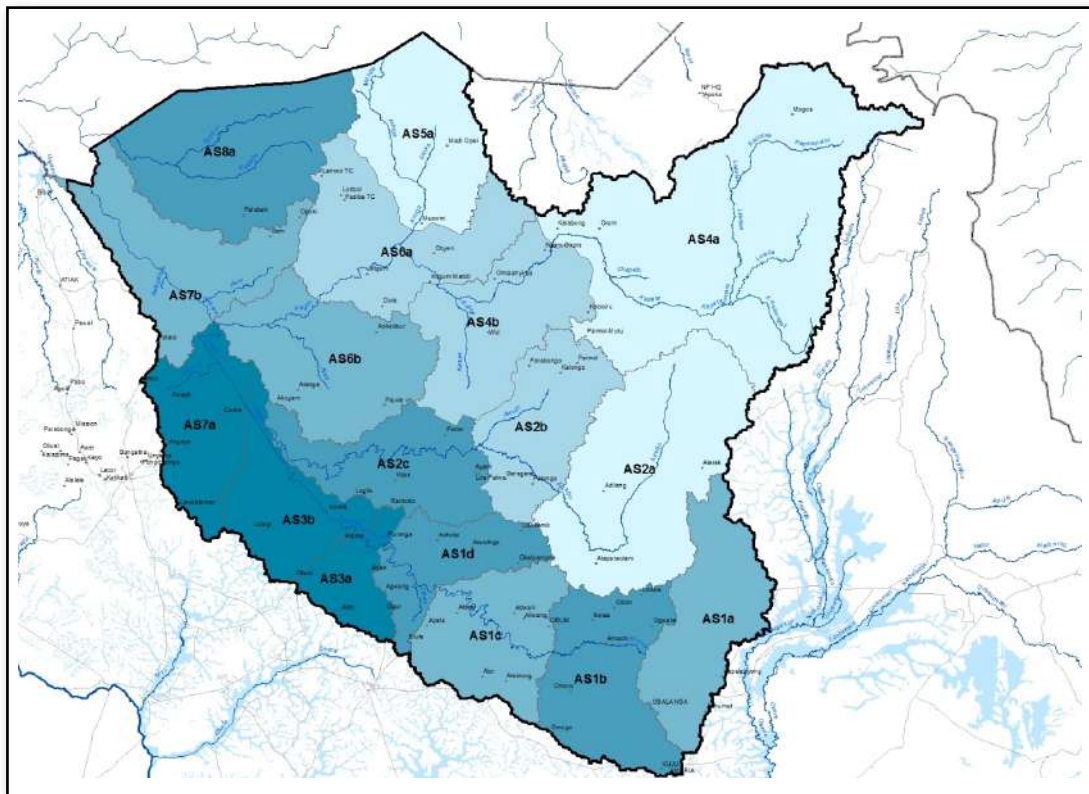

Figure 6.2: Potential for groundwater exploitation for Aswa sub-catchments

From this analysis the western part of the catchment is seen to be the most favourable for groundwater exploitation. Therefore, in these areas, hydrogeological investigations and pilot areas should be conducted prior to exploitation. More specifically, the knowledge base on groundwater resources and aquifers should be expanded and upgraded through the development of detailed hydrogeological studies on shallow aquifers and subsurface groundwater potential resources. These areas are then included in the map of opportunity.

Finally, it has to be noted the sustainable withdrawal is generally identified as a portion of the annual groundwater recharge in order to prevent the aquifer from being depleted. A conservative estimate of sustainable yield would be 10% of recharge, while less conservative percentages may exceed 70% (Ponce V.M., 2007). Experience indicates that other factors need to be considered, besides conservation, encouraging clean artificial recharge and optimise groundwater exploitation. Generally, a reasonable sustainable yield would be about 30-40% of recharge.

7.1 Implementation Plan

The Catchment Implementation Plan is composed of a series of proposed investment and management actions. The prioritisation and sequence of investment and management actions is based on activities related to stakeholders' consultation, identification of issues and opportunities, review of institutional arrangements, policies, and financing mechanism, etc. Annex 2 presents the detailed implementation plan including the costs associated with the actions for the three time frames; the short term (2017-2020), the medium term (2020-2025), and the long term (2025-2040).

7.2 Required Financing

Result of prioritisation and sequencing of investment and management actions presented in Annex 2 was costed to establish the required financing. The overall cost of an action is got by considering its preliminary cost estimate of each action and the scheduling of the cash flows. The approach used for costing is detailed in Annex 1.

According to the planning process, the CMP provides a sequenced implementation plan in three time periods, namely the short term (2017-2020), the medium term (2020-2025) and the long term (2025- 2040).

The sequenced and overall costs for each action are reported in Annex 2, while in Table 7.1 and Table 7.2 provide a summary of the overall sequenced costs by programme and sub-programme. Costs are provided both in US\$ and Uganda Shillings (UGX). An exchange rate of US\$1 to UGX3,350 was used.

Table 7.1: Overall Programmes' and sub-programmes' CMP costs (thousands US dollars).

Programme/ Sub-programme	2017-2020 US\$'000	2020-2025 US\$'000	2025-2040 US\$ '000	Total cost US\$ '000
Programme 1: Geo-database and GIS	228	14	43	285
Programme 2: Information Management System on WR	448	28	84	560
Sub-Programme 2.01: Information Management System on Water Bodies	90	6	17	113
Sub-Programme 2.02: Information Management System on Water Supply and Sanitation Facilities	177	11	33	222
Sub-Programme 2.03: Information Management System on Water for Production Facilities	180	11	34	225
Programme 3: Water Resources Monitoring	4,976	311	933	6,220
Programme 4: Water Resources Knowledge Base	3,029	189	568	3,786
Sub-Programme 4.01: Improve and Expand the Knowledge Base on Water Resources	1,073	67	201	1,342
Sub-Programme 4.02: Improve and Expand the Knowledge Base on Water Infrastructures and Facilities	1,423	89	267	1,779
Sub-Programme 4.03: Integrated Knowledge for Management of Water Resources	451	28	85	564
Sub-Programme 4.04: Knowledge Management and Exchange	81	5	15	101
Programme 5: Water Resources Planning and Regulation System	1,007	63	189	1,259
Programme 6: Water Sector Infrastructure and Facilities	61,416	374,183	1,122,548	1,558,146
Sub-Programme 6.01: Water Supply Infrastructure and Service	13,617	81,703	245,110	340,431
Sub-Programme 6.02: Sanitation Infrastructure and Service	23,511	141,066	423,199	587,777
Sub-Programme 6.03: Water for Production Facilities	24,288	151,413	454,238	629,939
Programme 7: Multipurpose Water Storage Facilities	1,608	19,695	59,084	80,387

Programme/ Sub-programme	2017-2020 US\$'000	2020-2025 US\$'000	2025-2040 US\$ '000	Total cost US\$ '000
Programme 8: Integrated Water and Land Management	2,264	13,582	40,747	56,593
Sub-Programme 8.01: Water Efficiency	14	81	243	338
Sub-Programme 8.02: Environmental Flows and Reserve Management System	23	136	408	567
Sub-Programme 8.03: Integrated Water and Land Management	2,213	13,281	39,842	55,336
Sub-Programme 8.04: Resilience to Climate Variability and Change	14	84	253	352
Programme 9: Stakeholder Engagement and Participatory IWRM	35	207	622	863
Sub-Programme 9.01: Stakeholder Engagement and Participatory IWRM	9	55	166	231
Sub-Programme 9.02: Awareness Raising	25	152	455	633
Programme 10: Technical Capacity Building	49	297	891	1,237

Table 7.2: Overall Programmes' and sub-programmes' CMP costs (millions shillings).

Programme/ Sub-programme	2017-2020 UGX '000 000	2020-2025 UGX '000 000	2025-2040 UGX '000 000	Total cost UGX '000 000
Programme 1: Geo-database and GIS	765	48	143	956
Programme 2: Information Management System on WR	1,500	94	281	1,875
<i>Sub-Programme 2.01: Information Management System on Water Bodies</i>	302	19	57	378
<i>Sub-Programme 2.02: Information Management System on Water Supply and Sanitation Facilities</i>	594	37	111	743
<i>Sub-Programme 2.03: Information Management System on Water for Production Facilities</i>	603	38	113	754
Programme 3: Water Resources Monitoring	16,671	1,042	3,126	20,838
Programme 4: Water Resources Knowledge Base	10,146	634	1,902	12,682
<i>Sub-Programme 4.01: Improve and Expand the Knowledge Base on Water Resources</i>	3,596	225	674	4,495
<i>Sub-Programme 4.02: Improve and Expand the Knowledge Base on Water Infrastructures and Facilities</i>	4,768	298	894	5,960
<i>Sub-Programme 4.03: Integrated Knowledge for Management of Water Resources</i>	1,511	94	283	1,889
<i>Sub-Programme 4.04: Knowledge Management and Exchange</i>	270	17	51	338
Programme 5: Water Resources Planning and Regulation System	3,374	211	633	4,218
Programme 6: Water Sector Infrastructure and Facilities	205,743	1,253,512	3,760,535	5,219,791
<i>Sub-Programme 6.01: Water Supply Infrastructure and Service</i>	45,618	273,706	821,119	1,140,443
<i>Sub-Programme 6.02: Sanitation Infrastructure and Service</i>	78,762	472,573	1,417,718	1,969,052
<i>Sub-Programme 6.03: Water for Production Facilities</i>	81,364	507,233	1,521,699	2,110,295
Programme 7: Multipurpose Water Storage Facilities	5,386	65,978	197,933	269,297
Programme 8: Integrated Water and Land Management	7,583	45,501	136,503	189,587
<i>Sub-Programme 8.01: Water Efficiency</i>	45	272	815	1,132

Programme/ Sub-programme	2017-2020 UGX '000 000	2020-2025 UGX '000 000	2025-2040 UGX '000 000	Total cost UGX '000 000
<i>Sub-Programme 8.02: Environmental Flows and Reserve Management System</i>	76	456	1,368	1,900
<i>Sub-Programme 8.03: Integrated Water and Land Management</i>	7,415	44,491	133,472	185,377
<i>Sub-Programme 8.04: Resilience to Climate Variability and Change</i>	47	283	848	1,178
Programme 9: Stakeholder Engagement and Participatory IWRM	116	694	2,083	2,893
<i>Sub-Programme 9.01: Stakeholder Engagement and Participatory IWRM</i>	31	186	557	774
<i>Sub-Programme 9.02: Awareness Raising</i>	85	509	1,526	2,119
Programme 10: Technical Capacity Building	166	994	2,983	4,144

7.3 Financing Sources

An overview of the main investment programmes and projects in the Water Sector has been carried out in order to evaluate the progress of relevant investment projects. At the local scale, regional and local government projects are undertaken by regional agencies and local government institutions and are funded through the local government financing mechanism (conditional grants). These projects are not included in the evaluation of main investment programmes and projects in the Water Sector. Local projects carried out by NGOs are also not included in the evaluation of main investment programmes and projects in the Water Sector.

7.3.1 Review of Financing Mechanisms

The key sources of financing currently include the Government of Uganda (GoU), the World Bank and the Joint Partnership Fund (Austrian Development Cooperation, DANIDA, and others).

Some donors also finance catchment-based WRM interventions through NGOs e.g. Austria Development Cooperation funding to IUCN for interventions in the Upper Aswa sub-catchment. The key concern is that existing financial resources are insufficient, sometimes characterised by budget cuts. For example, the Joint Partnership Fund for the UNWAZ reduced by 25% from about UGX1 billion in FY 2013/2014 to about UGX0.75 billion in FY 2014/2015.

Often, what is budgeted is also not actually realised, demonstrating inconsistency and unreliability in flow. The releases of funds usually delay, and even once received, sometimes processing of funds takes longer than anticipated owing to internal processes. The GoU funding contribution has also not yet been realised at zone level because of lack of a dedicated bank account. The phasing out of donor-funded projects (e.g. Phase 1 of IUCN's project in 2014) also often adversely affects the momentum already built in catchment-based WRM at the zone.

The impact is that service delivery cannot be achieved at targeted scale and in a timely fashion. The opportunity is that government and development partners seem to be committed to funding catchment-based WRM, and that this is only the beginning. Many other partners' interventions (e.g. NFA, WSDF, TSUs, Umbrella Organisation, NUSAF, etc.) could also leverage resources if good collaboration and networking arrangements are put in place. Fund processing time also seems to have improved with the opening of the zone's bank account in Lira.

7.3.2 Main Financing Sources for CMP

The implementation of the CMP plan will require funding from different sources, according to the type of action/intervention and of the relevant sectors involved in the implementation. These include mainly five sources: Water and Environment Sector Budget, Joint Partnership Fund (JPF), Sector Budget Support (SBS), off budget operations and private sector investments.

The Ministry of Water and Environment shall support implementation of the CMP and related programmes and sub-programmes through the Water and Environment Sector Budget, including direct field investments or promotion of investments from other institutions and development partners, enabling and coordination activities, training and capacity building, communications/awareness and stakeholder outreach and engagement activities, as well as procuring the recommended equipment, facilities and human resources.

The Government of Uganda (GoU) and Development Partners (DPs) are implementing the new Joint Water and Environment Sector Support Programme (JWESSP) 2013-2018 with the Ministry of Water and Environment (MWE) as the lead agency. The JPF is the main modality for harmonised sector funding of the majority of the JWESSP components. The JPF is a pooled fund managed by MWE that includes both non-earmarked funding and earmarked funding based on the different bilateral agreements between the GoU and sector development partners and other relevant documentation.

The JPF operations are aligned to government procedures in terms of financial management, auditing, reporting and procurement but funds are kept separate from the treasury funds. The Water and Environment Sector Working Group (WESWG) ensures coordination between national authorities and Development Partners.

An important potential funder of water and environmental projects is the Office of the Prime Minister through the Third Northern Uganda Social Action Fund (NUSAF-3), that has a budget of US\$130m for the period 2016-2021. The NUSAF-3 develops projects aiming at improving productive growth, human development, micro-economics, business skills, and commercial production. About 38% of the funds (US\$49m) are allocated for labour-intensive public works, 9% (US\$12m) for disaster risk financing and 33% (US\$43m) for livelihood investment support, including an Improved Household Income Support Programme and Sustainable Livelihoods Pilot.

The Sector Budget Support is used to channel funds to the local governments for activities to be implemented at the de-concentrated level, through conditional grants, directly from the treasury/MFPED to the Local Governments, in line with Uganda's fiscal de-concentration policy. Sector Budget Support is intended to be the preferred channel to contribute to the core funding of regulatory, water resources management and environment management activities.

Off-budget operations are forms of government operations that are not fully reconciled with the national budget and sector budget. The main forms of off-budget expenditures are off-budget funds, direct loans, guarantees, and public-private partnerships (PPPs). Other forms of off-budget expenditures are the budgetary funds and quasi-fiscal operations conducted through the public enterprises and sometimes the private sector, which are not covered by transfers from the national budget.

The engagement of the private sector in the management and development of water infrastructure and services is a key factor for the successful implementation of the CMP. Private actors might include either international or national, regional and local operators, as well as joint ventures among private operators with public institutions or utilities. The private sector can develop and implement a wide range of projects and activities in the Water and Environment Sector.

Public Private Partnerships (PPPs) are considered as an important tool in Uganda's plan to bridge the infrastructure financing gap in the next years. The PPP Act, passed in 2015, provides methods for procurement and the engagement of private partners in PPPs. It also regulates the roles and responsibilities of government bodies during the development and implementation of PPP projects. The PPP Act established two PPP agencies: the Public-Private Partnerships Committee as well as the Public-Private Partnerships Unit (within the Ministry of Finance).

Furthermore, the vital role of not-for-profit systems (CBOs and NGOs) shall be included in the private sector contribution to the implementation of the catchment WRDM plan.

7.3.3 Preliminary Strategy for Investment Interventions

The harmonisation, mainstreaming and accountability of the implementation of the CMP will be integrated within the existing cross-sectoral coordination framework for Water and Environment Sector funding. The Water and Environment Sector Working Group (WESWG) shall supervise the development of cross-sectoral programmes and sub-programmes of the WRDM Strategy and ensure harmonised implementation in line with the JWESSP objectives where non earmarked funding is provided through the JPF.

The government and the Ministry of Water and Environment shall be responsible for defining and establishing the institutional and financial framework for enabling the participation of the private sector in the implementation of CMP, overseeing its functioning and ensuring the provision of water-related public goods and services. In view of the monopolistic character of the water sector, regulation and oversight of tariff setting is paramount.

Because of the great amount of financial requirements, it is reliable to suppose the key sources of financing will be the GoU, through general taxation, supported by International Financial Institutions (IFIs). Investments from private sector would require higher discount rates.

For domestic water supply interventions, the larger part of financial need is expected to be provided by IFIs and in particular by the International Development Association (IDA), one of the agency of World Bank Group supporting developing countries. The development finance support given by IDA is in the form of very long-term loans (around 35–40 years), with long grace periods (up to 10 years) and with no interest payment, which is replaced by an annual servicing fee (0.75%).

As already indicated in the “Water for Production Strategy and Investment Plan” (DWMR, 2009), it is foreseen that for livestock facilities, 30% of the investments are carried out by commercial ranches directly and/or as subsistence livestock owners’ contributions. For irrigation facilities the off-farm investments in water supply infrastructure are carried out by the water sector, while all on-farm investments are done by the farmers or commercial enterprises. For aquaculture only 1% of the total investment in aquaculture facilities is financed by the water sector.

Differently for hydropower, because of marked intrinsic attractiveness, a large participation of the private sector is still ongoing (Renewable Energy Policy, REFiTand GETFitprogrammes of GoU supported by the IFIs).

Hydropower projects including large dams and multipurpose reservoirs have to be developed under the traditional model of a governmental agency or a public utility managing the various phases of the project life cycle. Multipurpose reservoirs and other storages facilities can have significant objectives and associated benefits in many sectors: besides water supply, irrigation, hydroelectric production and aquaculture, they help the maintenance of water quality and environmental flows, flood and climate change mitigation, but also tourism and leisure facilities. Therefore, multipurpose hydro projects need to be funded by public resources, drawing on IFIs aid when needed. The hydropower component could be room for private involvement in partnership with the public sector in multipurpose projects where an acceptable balance between risks and rewards can be achieved between the various stakeholders.

7.4 Pre-Feasibility studies for multi-purpose dams

A pre-feasibility study of each multipurpose dam identified in “Best scenario” (namely Scenario C) was carried out, the details of which are provided in a separate report. The costs associated with the implantation of each multi-purpose dam was computed, and the dams were given scores using multi-criteria analysis. They were then prioritised based on the MCA scores.

Table 7.3: Multi-Criteria Analysis score and costs (Million US dollars) of multipurpose dams

Multipurpose Storage ID	Name	Score	Priority	Overall Cost US\$'000 000
Multi_301	ASWA II	246	High	64
Multi_101	MOROTO	184		41
Multi_801	NYIMUR	180		50
Multi_501	KITGUM	122		28

In Table 7.4, the identified multipurpose storage projects with high priority are summarised with relative development objectives that can be achieved through their implementation.

Table 7.4: High priority multipurpose storage projects with relative achievable development objectives.

Name	River Name	Volume (MCM)	Served Towns (domestic WS)	Served Population (inhab.)	Irrigable area (ha)	Aquaculture (ha)	Hydropower generation (MW)
ASWA II	Aswa River	9.5	Akuyam, Atanga, Laguti	90,000	1,405	30	2.5
MOROTO	Moroto River	54	-	-	7,090	325	-
NYIMUR	Nyimur River	31	-	-	5,060	80	0.4
KITGUM	Aringa River	7.6	Kitgum	90,000	500	45	-

REFERENCES

National Reference Documents

1. Ministry of Water and Environment – Directorate of Water Resources Management, National Catchment Planning Guidelines, 2014
2. Ministry of Water and Environment – Directorate of Water Resources Management, National Water Resources Assessment report, 2013
3. Ministry of Water and Environment – Directorate of Water Resources Management, National Water Resources Strategy (draft), October 2014
4. Ministry of Water and Environment, Strategic Sector Investment Plan for the Water and Sanitation Sector in Uganda (2010-2035) Final, July 2009
5. Ministry of Water and Environment, A National Irrigation Master Plan for Uganda (2010-2035) Final Report, November 2011
6. Ministry of Water and Environment, Water and Sanitation Sector Sectoral Specific Schedules/Guidelines - 2012/13 - Final, May 2012
7. NBI –Nile Basin Decision Support System Analysis Manager Training Module

Reference Websites

8. Government of Uganda web-Portal <http://gov.ug/>
9. District Local Government websites <http://gov.ug/content/local-governments>
10. Ministry of Water and Environment www.mwe.go.ug
11. MWE, Water Supply Database <http://212.28.97.124/index.php/login>
12. MWE, Public Sanitation Database <http://www.publicsan.ug/>
13. MWE, Water and Sanitation Development Facility (WSDF) <http://wsdf.go.ug/>
14. National Water and Sewage Corporation <http://www.nwsc.co.ug/>
15. National Environmental Management authority www.nemaug.org
16. Ministry of Agriculture, Animal Industry and Fishery www.agriculture.go.ug
17. Ministry of Lands, Housing & Urban Development www.mlhud.go.ug
18. Ministry of Trade, Industry and Cooperatives www.mtic.go.ug
19. Ministry of Local Government <https://molg.go.ug>
20. Ministry of Tourism, Wildlife and Antiquities www.tourism.go.ug
21. Ministry of Energy and Minerals Development www.energyandminerals.go.ug
22. Ministry of Finance, Planning and Economic Development www.finance.go.ug
23. Ministry of Health www.health.go.ug
24. Ministry of Gender Labour and Social Development www.mglsd.go.ug
25. Ministry of Defence www.defence.go.ug

Other References

26. Conradin, K, et al, 2010, The SSWM Toolbox, Basel: Second international gmbh, URL: <http://www.sswm.info>
27. G. Karavokyris& Partners Consulting Engineers S.A., Z&A P. Antonaropoulos& Associates S.A., URS, Identification of a Multipurpose Water Resources Management and Development Project in Aswa Basin (Uganda/South Sudan), NBI, 2012
28. Planted Forests in Sustainable Forest Management, FAO,2010
29. Prepared by WOCAT Coordinated by the FAO of the UN, A TerrAfrica Partnership Publication, Sustainable Land Management in Practise, 2011
30. Tilley, E. et al, 2008. Compendium of Sanitation Systems and Technology
31. W. Critchley, K. Siegert, A Manual for the Design and Construction of Water Harvesting Schemes for Plant Production, Food and Agriculture Organization of the United Nations, Rome, 1991. <http://www.fao.org/docrep/u3160e/u3160e00.htm#Contents>

ANNEXES

ANNEX 1 – Estimation of Costs and Benefits

Estimation of costs and benefits considers mainly references, assumptions and parameterization already presented and used for comparison of scenarios in the option evaluation. However, further details are here included in order to assess a specific economic analysis of identified projects especially introducing more detailed unit costs.

The cost and benefit analysis is conducted evaluating parametric capital costs, operational and maintenance cost and benefits. The costs are presented in Euros(€), are generally related to m³ or ha, are escalated to equivalent 2016 prices and include design costs and implementation costs. Final cost has been converted to US\$, applying the conversion rate €1 = US\$1.13.

It has to be underlined in the present work the implementation of various development options is related to typical capital costs; more reliable cost estimates would be obtained identifying specific locations and undertaking additional investigations. Here below some tables where all unit costs are summarised.

Cost for infrastructure are distinguished for adduction and distribution and they change according to the magnitude of served population, irrigated hectares, installed capacity of hydropower. In particular, cost of infrastructures are estimated making reference to the following formula:

$$C_{add} = L^x \cdot Q^y \cdot z \quad \text{for adduction}$$

$$C_{dis} = A^j \cdot h \quad \text{for distribution}$$

Where L is the length of pipeline (m), Q is the flow (l/s) and A is the number of served people or irrigated hectares. Discharge Q is calculated for potable use considering 80 l/d per capita, while for irrigation 0.54 l/s/ha.

All the other parameters must be specifically set up in a calibration procedure or rather taking into account gathered information on cost evaluation for analogous works in Uganda and Consultant's experience. The following tables resume the values assigned to the calibration parameters.

ADDUCTION / PENSTOCK	
Parameter	Value
x	0.988
y	0.2883
z	0.05



ADDUCTION		
Parameter	Value	
	Potable	Irrigation
j	0.8907	0.95
h	0.5	8.0

In case of hydropower plants the cost of penstock pipes is estimated as above, except for the parameter z that changes according the diameter D: it is 0.1 for $D < 2$ m, 0.14 for $2 < D < 4.5$ and 0.165 for $D > 4.5$ m. The diameter D is calculated approximately as $1.5\sqrt{Q}$.

In case of power stations, the calculation implements the following equation:

$$C_{pow} = P^n \cdot H^k \cdot w$$

Where P is the nominal power in kW and H is the hydraulic drop in m. As for adduction and distribution all the other parameters are chosen during a calibration process. Because of the range of characteristics of hydropower plants (nominal power, hydraulic drop and discharge) is very wide the evaluation makes reference to Francis turbine.

POWER STATION	
Parameter	Value
n	0.481
k	-0.2858
w	33.676

For the concerns the dams the reference is the Term or Reference where parametric costs are indicated according to the different magnitude of storage volume. On the basis of this the curve representing relationship between unit cost (€ per cubic meter) and volume (V in MCM) is found:

$$C_{sto} = 0.7664 \cdot V^{-0.344}$$

The operation and management (O&M) costs are related to capital cost: in particular, the percentage of O&M is 0.35% for storages and 1.1% for Irrigation schemes. In case domestic water supply it is considered 10%. This latter value is elaborated from figures redacted in the "Uganda Water Supply and Sanitation - Country Status Overviews" (AMCOW, 2011);

Parametric values of benefit are estimated through some intermediate non-financial parameter in order to transform hectares for irrigation and aquaculture to tons of harvesting and fish. It is assumed the two main product from irrigation would be beans and groundnuts (equal portion).

Production rate for beans and groundnuts from "Production and marketed surplus of Uganda 1999-2006 (USSP-WP9)" by International Food Policy Research Institute (IFPRI) and for fish from "Aquaculture Technical Manual USSPB05" by MAAIF.

INTERMEDIATE NON-FINANCIAL BENEFITS	
Item	Unit Benefit (t/ha)
Beans	2
Groundnuts	2.7
Fish	2.7

For domestic water supply unit benefit makes reference to NWSC tariff structure for 2013/2014 ("Water & Environ-ment Sector Performance Report" by MWE, 2014). The other unit benefits are taken from Awoja CMP (2013).

FINANCIAL BENEFITS		
Item	Unit reference	Benefit value
Domestic water supply Livestock	US\$/m ³	0.61
Irrigation - beans Irrigation -	US\$/TLU	5.48
groundnuts Fish	US\$/t	322
	US\$/t	401
	US\$/t	605

The applicable tariff for hydropower are taken from the ERA²: tariff is 0.115 USD/kWh if installed capacity is between 500kW and 1MW, it is 0.085 for hydropower higher than 9 MW and it varies linearly between 1 MW and 9MW.

Taking into account the above mentioned criteria, capital cost, operational and maintenance costs and benefits are calculated for the identified Multipurpose Projects. The results of this evaluation is included in the detailed pre-feasibility studies for these projects.

It is believed this analysis has included any kind of the main potential cost and benefit that can be foreseen in this preliminary project phase. Costs that are not explicitly considered are assumed to be negligible. This is the case, for instance, of expenses related to people living in the impounded areas: the proposed sites are selected also considering to minimize the needs to resettlement. Besides, aiming at a conservative evaluation of benefits, only the most relevant incomes are considered. Finally, it has to be noted that all negative and positive impact not relate to financial analysis are included in the following multi-criteria analysis.

Multi-Criteria Analysis

Multi-criteria analysis (MCA) establishes preferences between options by reference to an explicit set of objectives identified, and for which were established measurable criteria/indicator to assess the extent to which the objectives have been achieved.

The weighted average method is the proposed method. Where it is possible to describe the consequences of a certain project in terms of a single set of characteristics, their relative merits are expressed in numeric form, for instance ranging from 0 for very unfavourable characteristics to 100 for very favourable ones.

Using the weighted-average method, a table is set up where each competing project is listed and its scores against each characteristic are tabulated. The scoring rule for each characteristic is the way in which the facts about a project are converted into its merit score. Indicator/parameters can be mathematical, like a proportional relationship between cost-benefit ratio or could use indicators and the related score, or they can be based on qualitative considerations, based on expert judgement. Each characteristic corresponds to a criterion, and its scoring rule corresponds to the way the decision-makers want that criterion to be applied.

In addition to the set of scoring rules and the set of scores for various projects, the applied method needs a set of criterion importance weights. As already mentioned, these weights are shared with DWRM and stakeholders in order to have a feedback to refine the list of criteria and their weights, and then set of scoring rules, in an iterative discussion.

After these steps, the analysis is simple arithmetic: for each project an overall merit score is calculated as the weighted average of its scores under the different criteria. At the end a table with a ranking representing the results of the multi-criteria analysis could easily represent the prioritization of the scenarios.

Multi-criteria approach used to compare alternative projects (i.e. multipurpose dams) includes economic, social and environmental factors. Table below shows selected NB-DSS indicators used, their group and their brief description.

It should be noted the same approach has been implemented during the comparison of scenarios in the previous phase "Option Evaluation", while indicators are slightly different because this now the multi-criteria analysis is related specifically to a single project.

2 <http://www.era.or.ug/index.php/statistics-tariffs/tariffs/2014-09-08-13-29-51/feed-in-tariff>

Table A: NB-DSS indicators used for scenario evaluation

Indicator	Description	Group
Served people (habitant)	Population that can be water supplied by reservoir	Social
Extent of irrigation area (Ha)	Irrigable area that can be water supplied by reservoir	
Benefit – Cost ratio	Ratio between yearly benefit and the sum of capital costs (divided in 25 years) and yearly O&M costs	Economic
Energy production (MW)	Hydro Power Plant capacity	
Wet flow duration	Calculated as ratio between total storage volume and water resource in dry semester	Environmental
Ecological stress	Calculated as the sum of dam height (multiplied by 10), dam length and impounded area (in km ² , multiplied by 1000); the resulting value can be used to evaluate impact of the infrastructure on environment	

The values of indicators for each project are reported in the detailed pre-feasibility studies for selected multipurpose projects. Then, in order to compare all indicators, they were normalized: using the “unit –vector” method, one of the techniques included in NB-DSS, the values of different indicators were scaled to the range between 0 and 1. The “unit-vector” formula is:

$$v_i = \frac{i}{\sqrt{\sum a_i^2}}$$

With:

- a : the measurement of a criterion;
- ai : the criterion measurement for any given project; and
- vi : normalized value of ai.

Selected criteria/indicator must be weighted in order to reflect their relative importance to the decisions. The weights were defined taking into account the relevance of each indicator from three different viewpoints: economic, environmental and social factor.

Table B: Criteria weighting used for scenario evaluation

Indicator	Weight (%)	Group
Served people (habitant)	30	SOCIAL
Extent of irrigation area (Ha)	15	
Benefit – Cost ratio	20	ECONOMIC
Energy production (MW)	10	
Wet flow duration	15	ENVIRONMENTAL
Ecological stress	10	

For each project normalised values of indicators and weights were multiplied, add together (except the indicator on ecological stress that is subtracted being negative). The final score of each project is divided by the average score of all projects and then multiplied by 100: this leads to identify project that are better than the average (values higher than 100) and project worst (lower than 100).

The values assigned to each indicator are reported in Table C, while the final score of each project is quoted in paragraph 6.

Table C: Value of Indicators in Multipurpose Multi-Criteria Analysis

Multipurpose		Financial		Social		Environment	
ID	Name	B/C	Power (MW)	Served people	Irrigation (ha)	Wet flow duration %	Ecostress
Multi_202	PANYANGO II	2.3	0.0	0	517	6	740
Multi_206	PANYANGO III	6.1	5.0	0	1,105	9	1,356
Multi_209_10	PANYANGO I	1.0	0.0	31,493	389	362	1,101
Multi_301	OME I	3.8	0.0	0	1,233	57	1,407
Multi_302	OME II	3.2	0.0	0	2,966	78	3,237
Multi_303	OME III	2.9	2.0	0	572	9	1,002
Multi_401_20	ORA I	1.0	0.1	14,092	452	90	874
Multi_403	ORA VII	2.7	0.1	0	1,740	129	1,848
Multi_404	ORA IV	2.4	1.5	0	349	5	654
Multi_405	ORA V	3.8	0.0	0	5,457	140	5,650
Multi_406	ORA VI	6.5	5.2	0	284	4	583
Multi_407	ORA VIII	3.6	1.5	0	389	5	696
Multi_408_20	ORA II	1.3	0.3	0	118	12	463
Multi_409_20	ORA III	0.9	0.1	71,114	499	61	847
Multi_410		6.8	0.4	0	0	0	0
Multi_501_10	UP ENYAU VIII	0.3	0.0	0	21	123	183
Multi_502_20	UP_ENYAU I	1.4	0.2	0	222	30	483
Multi_503	UP ENYAU VII	2.9	0.5	0	438	14	671
Multi_504_20	UP_ENYAU II	1.9	0.2	0	581	186	829
Multi_505_20	UP ENYAU V	1.4	0.1	0	140	18	506
Multi_506_20	UP ENYAU VI	3.1	0.3	0	973	36	1,412
Multi_508_10	UP ENYAU III	0.5	0.1	0	5	3	180
Multi_510	UP ENYAU IX	2.3	0.1	0	77	16	413
Multi_511_20	UP_ENYAU IV	1.3	0.0	0	242	187	560
Multi_601_20	ENYAU I	0.9	0.0	127,399	977	47	2,254
Multi_603_20	ENYAU II	3.4	1.6	0	1,055	14	1,459
Multi_605_20	ENYAU IV	3.7	2.4	0	366	2	531
Multi_606_20	ENYAU V	6.0	4.2	0	255	2	493
Multi_610_20	ENYAU III	3.7	0.6	0	709	20	1,063
Multi_701	UP KOCHI I	1.5	0.6	0	121	10	441
Multi_702	UP KOCHI II	1.0	0.0	0	175	12	582
Multi_703	UP KOCHI III	1.6	0.3	0	336	53	1,148
Multi_801_20	KOCHI I	0.7	0.1	76,908	110	106	1,150
Multi_802_20	KOCHI II	2.5	0.0	72,397	5,628	179	5,625
Multi_805_20	KOCHI III	3.1	0.0	0	746	10	954

Multipurpose		Financial		Social		Environment	
ID	Name	B/C	Power (MW)	Served people	Irrigation (ha)	Wet flow duration %	Ecostress
Multi_806_20	KOCHI IV	0.7	0.1	76,908	168	134	787
Multi_901	LAROPI II	0.8	0.0	21,364	184	289	1,104
Multi_902	LAROPI III	2.9	0.1	0	270	118	991
Multi_903	LAROPI IV	1.1	0.0	21,364	467	289	1,631
Multi_904_10	LAROPI I	0.7	0.0	17,223	128	289	467
Multi_905		0.8	0.0	0	0	0	0
Multi_906		3.0	0.1	0	0	0	0
Multi_907	LAROPI V	1.2	0.3	19,336	690	154	1,135
Multi_1001	AYUGI II	2.7	0.0	0	885	10	1,117
Multi_1003_20	AYUGI I	1.1	0.0	121,996	1,116	144	1,591
Multi_1004		1.8	0.0	0	0	0	0
Multi_1005	AYUGI III	1.1	0.1	19,336	364	429	735
Multi_1006		4.4	0.1	0	0	0	0
Multi_1101_20	UNYAMA I	1.0	0.0	309,618	1,026	408	4,715
Multi_1103_10	UNYAMA II	1.2	0.0	0	265	154	1,021
Multi_1107	UNYAMA III	4.0	0.8	0	2,222	32	2,923
Multi_1108	UNYAMA IV	3.8	4.0	0	2,614	30	3,269
Multi_1110	UNYAMA V	3.6	0.0	0	729	6	1,102

Annex 2 - Implementation Plan

Aswa Catchment: Investment and Management Actions

PROGRAMME 1: Create a GIS infrastructure to support data storage, elaboration, exchange, and information management of Aswa Catchment. Develop technical guidelines, protocols and specifications for GIS-database population and management of spatial information, including Geo-database and GIS Atlas management of metadata of Aswa Catchment. Create and implement a web-GIS database for publication of relevant information on water resources, water permits and water source protection measures. Develop and implement a comprehensive GIS database of areas with integrated land and water management measures in the Aswa Catchment, including: reforestation / afforestation, river corridors and ecologic corridors, wetland restoration and protection, riverbanks and aquatic ecosystem restoration, water scenic landscape protection, and protected areas.

Upper Nile WMZ Programme Leader: DWRM

Support Institutions	Action ID	Action to be implemented	Priority Area	Indicator	2017-2020 (US\$ '000)	2020-2025 (US\$ '000)	2025-2040 (US\$ '000)	Total Cost (Ua\$ '000)	Total Cost for Implementation ONLY in Priority Area (US\$ '000)
----------------------	-----------	--------------------------	---------------	-----------	-----------------------	-----------------------	-----------------------	------------------------	---

Upper Nile WMZ, UBOS, NPA, Districts	1.1.2	Establish and maintain a GIS based knowledge and information management system for the Aswa Catchment		Number of GIS layers implemented, % coverage, % integration achieved, Number of users, Number of documents issued, by type	42	3	8	52	
Upper Nile WMZ, Districts	1.1.3	Establish and maintain a Web-GIS database of water resources		Number of GIS layers implemented, % coverage,	42	3	8	52	
Upper Nile WMZ, Districts	1.4.1 1.4.2 1.4.3	Establish and maintain a Web-GIS database of water permits, water source protection measures and areas with integrated land and water management measures		Number of GIS layers implemented, % coverage, Number of permits registered, by type, Number of water sources with WSP measures, Number of areas mapped, by type	145	9	27	181	

PROGRAMME 2: Upper Nile WMZ Information Management System on WR
Programme Leader: UN-WMZ

Collect, access, analyse and share a wide range of information for the purposes of evaluating water resources and operational management.
Establish and maintain a GIS based Inventory of Water Discharge Points, existing and planned sanitation facilities (sewerage and WWTPs) in urban areas, Water Permits on water bodies that are used for domestic/livelihood water supply, water for production facilities of Production, Industrial and Agricultural Sectors and hydropower plants (existing and planned). Create a GIS based inventory of water bodies in Catchment, based on the assessment of their hydrological, geo- morphological and ecological state (SW and GW bodies).

Support Institutions	Action ID	Action to be implemented	Priority Area	Indicator	2017-2020 (US\$ '000)	2020-2025 (US\$ '000)	2025-2040 (US\$ '000)	Total Cost (US\$ '000)	Total Cost for Implementation ONLY in Priority Area (US\$ '000)
----------------------	-----------	--------------------------	---------------	-----------	-----------------------	-----------------------	-----------------------	------------------------	---

SUB-PROGRAMME: Upper Nile WMZ Information Management System on Water Bodies
Sub-Programme Leader: UN-WMZ

DWRM, DWD, DEA, NEMA, NFA, Districts	1.1.1	Collection, storage, elaboration and management of integrated data on water resources in the Aswa Catchment		Collection of data: Number of documents issued, by type	45	3	8	56	
--------------------------------------	-------	---	--	---	----	---	---	----	--

DWRM, DWD, DEA, NEMA, NFA, Districts	8.1.1	Improve information management on functional and ecological state of water bodies		Number of GIS layers implemented, % coverage, Number of water bodies mapped (by type, location, WQ, ecological state), Number of water bodies mapped (by type, location, severity of degradation state)	45	3	8	56	
--------------------------------------	-------	---	--	---	----	---	---	----	--

SUB-PROGRAMME: Upper Nile WMZ Information Management System on Water Supply and Sanitation Facilities

Sub-Programme Leader: UN-WMZ

DWD, NWSC, Districts	2.1.1	Improve information management on WQ for Water supply		Number of GIS layers, % coverage, Number of WS facilities (by type, location, source of water, use)	32	2	6	40	
DWD, NWSC, Districts	2.2.1	Improve information management on Water Permits for Water Supply (SW and GW)		Number of GIS layers implemented, % coverage, Number of water permits (by type, location, water body, user)	32	2	6	40	
DWD, NWSC, Districts	3.1.1	Improve information management on wastewater discharge points		% coverage, Number of water discharge points (by type, location, facility, WQ, recipient water body)	32	2	6	40	
DWD, NWSC, Districts	3.1.2	Improve information management on sanitation facilities		Number of GIS layers implemented % coverage Number of sanitation facilities (by type, capacity, location)	81	5	15	101	

SUB-PROGRAMME: Upper Nile WMZ Information Management System on Water for Production Facilities

Sub-Programme Leader: DWD

MAAIF, MEMD, MIT, Districts	4.1.1 5.1.1 6.1.1	Improve information management on Water for Production facilities for agricultural, industrial and other sectors		Number of GIS layers implemented, % coverage, Number of WfP facilities (by type, location, capacity, use)	167	10	31	209	
MAAIF, MEMD, MIT, Districts	7.1.1	Improve information management on hydro-power plants		Number of GIS layers implemented, % coverage, Number of HP facilities (by type, location, capacity, status)	13	1	2	17	

<p>PROGRAMME 3: Collect, access, analyse and share a wide range of information for the purposes of monitoring water resources and operational management. Expand and upgrade the hydro-meteorological monitoring network, hydrogeological monitoring system and WQ monitoring system. Develop an Environmental Monitoring Program on water bodies (SW and GW) to determine their ecological state. Training activities of Catchment/WMZ technical staff by Consultants (Hydrologist and Environmental expert), implementation of maps, Capacity building organization and stakeholder engagement at local/community level, will be developed in 8 year. Two training activities/technical support to Catchment/WMZ staff are foreseen per year: 2 Consultants to assist 3 technical employees, duration of 20 hours. Total cost include also additional 15 hours/training of Catchment/WMZ staff to train, coordinate and assist technical local staff (e.g. employees of local offices, local technicians etc.). One Stakeholder meeting is foreseen, every two years.</p>									
Support Institutions	Action ID	Action to be implemented	Priority Area	Indicator	2017-2020 (US\$'000)	2020-2025 (US\$'000)	2025-2040 (US\$'000)	Total Cost (US\$'000)	Total Cost for Implementation ONLY in Priority Area (US\$'000)
DWRM, Districts, NEMA, DEA, UNMA	1.1.4	Expand and upgrade the hydro-meteorological monitoring network		Number of hydro-meteorological stations operational, % coverage	1,791	112	336	2,239	
DWRM, Districts, NEMA, DEA, UNMA	1.1.5	Expand and upgrade the GW and hydrogeological monitoring system		Number of GW stations operational % coverage	1,791	112	336	2,239	
DWRM, Districts, NEMA, DEA, UNMA	1.1.7	Expand and upgrade the WQ monitoring network and laboratory facilities for surface and groundwater bodies		Number of WQ stations operational, WQ samples tested	1,281	80	240	1,602	
DWRM, Districts, NEMA, DEA, UNMA	8.1.2	Develop an Environmental Monitoring Programme on water bodies (SW and GW) to determine their ecological state		% of Aswa covered, Number of water bodies mapped (by type, location, WQ, ecological state and trend)	113	7	21	141	

PROGRAMME 4: Upper Nile WMZ Water Resources Knowledge Base Programme Leader: UN-WMZ		Implement and maintain a comprehensive knowledge base on Water Resources and Water Resources management through the achieve of reference documents and information (paper and digital document) and implementation of GIS Atlas and Web-Gis Database on Water Resources and on Water Infrastructure and Facilities (existing and planned).							
Support Institutions	Action ID	Action to be implemented	Priority Area	Indicator	2017-2020 (US\$'000)	2020-2025 (US\$'000)	2025-2040 (US\$'000)	Total Cost (US\$'000)	Total Cost for Implementation ONLY in Priority Area (US\$'000)
SUB-PROGRAMME: Improve and Expand the Knowledge Base on Water Resources									
Sub-Programme Leader: UN-WMZ									
DWRM, DWD, Districts, NEMA DEA, UNMA	1.1.6	Expand and upgrade the knowledge base on ground-water resources and aquifers		Number of GIS layers implemented, % coverage, Number of aquifers mapped	113	7	21	141	
DWRM, DWD, Districts, NEMA DEA, UNMA	1.4.4 9.1.2	Improve knowledge base on flood risk, create and maintain an inventory of flood prone areas		Number of GIS layers implemented, % coverage, Number of areas mapped, by type, % population at risk	161	10	30	202	
DWRM, DWD, Districts, NEMA DEA, UNMA	1.4.5 9.1.3	Improve knowledge base on drought risk, create and maintain an inventory of drought prone areas		Number of GIS layers implemented, % coverage, Number of areas mapped, by type, % population at risk	161	10	30	202	
DWRM, DWD, Districts, NEMA DEA, UNMA	1.4.8	Improve the knowledge base on environmental flows and water reserve		Number of GIS layers implemented, % coverage Number of facilities, by type	45	3	8	56	

DWRM, DWD, Districts, NEMA, DEA, UNMA	1.4.9	Implement and maintain a comprehensive knowledge base, including a library and archive of reference documents (i.e. research and studies, cartography, field surveys, monitoring data, etc.)		Number of documents issued, by type	45	3	8	56	
DWRM, DWD, Districts, NEMA, DEA, UNMA	8.4.1	Expand the knowledge base on wetlands for improving wetland management and protection		Number of GIS layers implemented, % coverage, Number of wetlands mapped (by type, location, area, ecological state, uses)	435	27	82	544	
DWRM, DWD, Districts, NEMA, DEA, UNMA	9.1.1	Create a knowledge base on vulnerability of water resources and land to climate variability and change		Web-database, % coverage Number of user access	113	7	21	141	
SUB-PROGRAMME: Improve and Expand the Knowledge Base on Water Infrastructures and Facilities Sub-Programme Leader: UN-WMZ									
DWD, NWSC, Districts	1.3.1	Improve the knowledge base on the water supply and sanitation service coverage		Number of GIS layers implemented, % coverage, % population covered, Number of WSS facilities mapped, by type	32	2	6	40	

DWD, NWSC, Districts	1.3.2 1.3.3	Improve the knowledge base on the state of water supply and sanitation (WSS) existing infrastructures and projects		Number of WSS facilities mapped, by type Number of WSS projects, by type	64	4	12	81	
DWD, NWSC, Districts	1.3.4	Improve the knowledge base on the water for production supply coverage		Number of GIS layers implemented, % coverage, % population, % demand met, water uses, by type	25	2	5	31	
DWD, NWSC, Districts	1.3.5 1.3.6	Improve the knowledge base on the state of water for production existing facilities and projects		Number of WFP facilities mapped, by type Number of WFP projects, by type	86	5	16	108	
DWD, NWSC, Districts	1.3.7 1.3.8	Improve the knowledge base on the industrial water supply facilities and on the state of industrial water supply projects		Number of Industrial Water Supply facilities mapped, by type, Number of Industrial Water Supply Projects, by type	77	5	14	96	
DWD, NWSC, Districts	1.3.11 1.3.12	Improve the knowledge base on the hydropower facilities and on the state of hydropower projects		Number of HP Facilities mapped, by type, Number of Hydropower Projects, by type	26	2	5	33	

DWD, NWSC, Districts	1.3.13 1.3.14	Improve the knowledge base on the multipurpose facilities and on the state of multipurpose projects		Number of Multipurpose Facilities mapped, by type, Number of Multipurpose Facilities Projects, by type	180	11	34	225	
DWD, NWSC, Districts	1.3.15	Improve the knowledge base on the water works		Number of GIS layers implemented. % coverage. Number of water works mapped, by type	113	7	21	141	
DWD, NWSC, Districts	3.3.1	Develop the knowledge base for a Water and Sanitation Programme		Number of aquifers. Number of GIS layers implemented. % coverage	281	18	53	352	
DWD, NWSC, Districts	5.3.1	Develop the knowledge base for an Industrial Water for Production Programme		Number of GIS layers implemented. % coverage. Number of WFP facilities planned (by type, location, source water body, capacity, use)	96	6	18	120	
DWD, NWSC, Districts	6.4.1	Develop the knowledge base for a Road Infrastructure Drainage Programme		Number of GIS layers implemented. % coverage. Number of roads mapped (by type)	81	5	15	101	

DWD, NWSC, Districts	7.2.1	Develop the knowledge base for establishing an Energy Peak Demand Management System		Technical Standard on hydro-power and pumped hydro-electric storage / Number of documents issued, by type	81	5	15	101	
DWD, NWSC, Districts	9.3.1	Develop the knowledge base to increase infrastructure resilience to climate variability and change		Number GIS layers implemented. % coverage. Km roads mapped (by type)	281	18	53	352	

SUB-PROGRAMME: Integrated Knowledge for Management of Water Resources
Sub-Programme Leader: UN-WMZ

DWRM, DWD, DEA, NEMA, NFA, MAAIF, MEMD, MIT, Districts	3.1.3 3.4.1 4.4.1 5.4.4	Develop the knowledge base for an Integrated Pollution Prevention and Control Programme (including also industrial pollution) and a Sediment Management Programme		Number GIS layers implemented, % coverage, Number of pollution and sediment load sources (by type, location, WQ, priority pollutants, sediment load, recipient water body)	226	14	42	282	
DWRM, DWD, DEA, NEMA, NFA, MAAIF, MEMD, MIT, Districts	4.4.3	Develop the knowledge base for an Integrated Land & Water Management Programme		Number of GIS layers implemented, % coverage, Number of land degradation hotspots (by type, location, WQ, pollution load, recipient water body)	113	7	21	141	

DWRM, DWD, DEA, NEMA, NFA, MAAIF, MEMD, MIT, Districts	6.4.2	Develop the knowledge base for a Water Landscapes Valorisation Programme		Number of water bodies mapped, Number of GIS layers implemented, % coverage	113	7	21	141	
--	-------	--	--	---	-----	---	----	-----	--

SUB-PROGRAMME: Knowledge Management and Exchange
Sub-Programme Leader: UN-WMZ

DWRM, DWD, Districts, CMO, MSE, MLG	1.1.9	Disseminate knowledge on water resources		Number of publications produced, by type	81	5	15	101	
-------------------------------------	-------	--	--	--	----	---	----	-----	--

PROGRAMME 5: Water Resources Planning and Regulation System
Programme Leader: UN-WMZ
 Establish and maintain a Upper Nile WMZ Modelling Unit, improve and expand the water permit management system in the WMZ/Aswa Catchment. Establish and operationalize the Catchment Management Organizations in the Upper Nile WMZ; develop Water Sector funding mechanisms for deconcentrated IWRM implementation at the WMZ and catchment levels. Develop water source protection plans and promote integrated pollution prevention and control in the Upper Nile WMZ.

Support Institutions	Action ID	Action to be implemented	Priority Area	Indicator	2017-2020 (US\$'000)	2020-2025 (US\$ '000)	2025-2040 (US\$ '000)	Total Cost (US\$'000)	Total Cost for Implementation ONLY in Priority Area (US\$'000)
DWRM, DWD, DEA, WESWG, CMO	1.1.8	Establish and maintain a Modelling Unit		Number of staff assigned Number of documents issued, by type	259	16	49	324	
DWRM, DWD, DEA, WESWG, CMO	1.2.1	Strengthen and enforce the IWRM regulatory framework		Number of documents issued, by type	42	3	8	52	
DWRM, DWD, DEA, WESWG, CMO	1.2.2	Improve and expand the water permit management system		Number of inspections and controls planned % coverage	32	2	6	40	
DWRM, DWD, DEA, WESWG, CMO	1.2.5	Establish and operationalize the Catchment Management Organizations		% coverage. Capital Investment per capita per year	104	7	20	130	

DWRM, DWD, DEA, WESWG, CMO	1.2.6	Develop Water Sector funding mechanisms for deconcentrated IWRM implementation		Number of documents issued, by type	104	7	20	130	
DWRM, DWD, DEA, WESWG, CMO	1.4.10	Establish a cross-sectoral and cross-level coordination platform for WRMD planning		Number of documents issued, by type	104	7	20	130	
DWRM, DWD, DEA, WESWG, CMO	2.4.2	Develop Water Source Protection Plans		Number of WSP Plans developed and implemented, by sub-catchment Number of water sources with WSP Boards/ Committees established Number of documents issued, by type	281	18	53	352	
DWRM, DWD, DEA, WESWG, CMO	3.2.2	Promote Integrated Pollution Prevention and Control		Number of documents issued, by type	81	5	15	101	

PROGRAMME 6: Water Sector Infrastructure and Facilities
 Programme Leader: DWD
 Ensure adequate water quality control on water supplied for domestic/household use (SW and GW sources), water supplied for production (SW and GW) for Agricultural Production and for Industrial production. Define and operationalize a Technical Standard for water for production storage facilities and infrastructure design, construction and management, including multipurpose facilities. Improve management of sludge from sewage and sanitation facilities.

Support Institutions	Action ID	Action to be implemented	Priority Area	Indicator	2017-2020 (US \$'000)	2020-2025 (US\$ '000)	2025-2040 (US\$ '000)	Total Cost (US\$ '000)	Total Cost for Implementation ONLY in Priority Area (US\$'000)
----------------------	-----------	--------------------------	---------------	-----------	-----------------------	-----------------------	-----------------------	------------------------	--

SUB-PROGRAMME: Water Supply Infrastructure and Service
 Sub-Programme Leader: DWD

DWRM, WSDF, TSU, UO, Districts	2.1.2	Ensure adequate water quality control on water supplied for domestic/household use (SW and GW sources), including the provision of WQ testing kits		% of As-wa catchment covered Number of WQ controls (by type, location, source of water, use), Number of kits provided	64	384	1,153	1,602	
DWRM, WSDF, TSU, UO, Districts	2.3.1	Expand the water supply infrastructures for full coverage of urban and rural population	Large urban centres of Kitgum and Abim and RGCs	% population covered, Number of WSS facilities planned (type, capacity)	13,106	78,634	235,901	327,640	11,467
DWRM, WSDF, TSU, UO, Districts	2.3.4	Develop water supply facilities using groundwater sources in areas with water deficit	Gulu, Pader, Oyam, Kole, Lamwo, Lira, Alebtong, Amuria, Otuke districts	Towns served by groundwater schemes implemented. Number of boreholes constructed	427	2,560	7,681	10,668	5,334
DWRM, WSDF, TSU, UO, Districts	2.3.6	Expand rainwater harvesting facilities in areas with seasonal water deficit	North-eastern part of the catchment	Number of documents issued, by type	21	125	375	521	260
SUB-PROGRAMME: Sanitation Infrastructure and Service Sub-Programme Leader: DWD									

NWSC, Districts	3.3.2	Improve management of sludge from sewage and sanitation facilities	Large urban centres (Kitgum and Abim), areas with increasing population density (towns, RGCs)	Number of documents issued, by type, Number of plans for sludge management, Number of treatment plants with relative treatment capacity, sewerage extension and coverage	23,158	138,950	416,851	578,960	57,896
NWSC, Districts	3.3.3	Improve sanitation and hygiene facilities in public buildings	Large urban centres (Kitgum and Abim), areas with increasing population density (towns, RGCs)	Number of documents issued, by type, Number of improved sanitation facilities	353	2,116	6,348	8,817	882

SUB-PROGRAMME: Water for Production Facilities
Sub-Programme Leader: DWD

DWRM, MAAIF, MEMD, MIT, OPM	4.1.2 5.1.2 6.1.2	Ensure adequate quality control on water supplied for production (SW and GW), including agricultural production, industrial sector and tourism		% of Catchment covered Number of WQ controls (by type, location, water source, use)	5	30	89	123	
DWRM, MAAIF, MEMD, MIT, OPM	4.3.1	Improve water for production facilities	Kotido, Kaabong and Lamwo districts	Number of documents issued, by type	1	7	22	31	15
DWRM, MAAIF, MEMD, MIT, OPM	4.3.2	Rehabilitate and improve functionality of existing water for production storage facilities	Lamwo, Kotido, Kaabong, Kitgum, Agago and Abim Districts	Number of WfP storage facilities rehabilitated (by type, location, water source, use)	135	810	2,429	3,374	1,687

DWRM, MAAIF, MEMD, MIT, OPM	4.3.3.B	Increase water for production storage capacity in areas with seasonal deficits of Upper Nile WMZ (small storages)	Kitgum and Agago Dis-tricts	Number of WfP small storage built (type, capacity, location, water source, use)	12,669	76,016	228,049	316,734	158,367
DWRM, MAAIF, MEMD, MIT, OPM	4.3.5	Develop underground water storage for production in areas with water deficit	Kotido, Kaa-bong and Abim Districts	Num-ber of aquifers bodies, % coverage, Number of storag-es (type, capacity, location, use)	1,408	8,446	25,339	35,193	28,154
DWRM, MAAIF, MEMD, MIT, OPM	4.3.6	Expand irrigation schemes	Along Aswa and Nyimur rivers (Aswa I, II, III and Nyimur sub- catch-ments)	Number of irri-gation schemes planned and con-structed (by type, area, water source, capacity, use), ar-eas under irrigation	4,607	27,643	82,928	115,177	57,589
DWRM, MAAIF, MEMD, MIT, OPM	4.3.8	Improve water for production facilities for aquaculture	South-ern part of Aswa Catchment (Aswa I and II sub-catchments)	Number of doc-uments with Technical Stan-dards on aqua-culture, Number of and extent of aqua-culture ponds by district	4,546	27,277	81,832	113,655	45,462
DWRM, DWD, DEA, OPM, WESWG, MEMD, MIT, MAA-IF, NFA	5.3.2	Develop adequate supply net-work infra-structure for industrial production	Large urban centre of Kitgum	Number of doc-uments issued, by type cov-erage of industrial water supply	910	11,146	33,439	45,495	22,747

DWRM, DWD, DEA, OPM, WESWG, MEMD, MIT, MAAIF, NFA	5.3.3	Promote integrated development of agro-tourism and agro-industrial processing facilities	Southern part of Aswa Catchment	Number of documents issued, by type, Number of tourists/year, Number of market facilities realized	5	31	94	130	104
DWRM, DWD, DEA, OPM, WESWG, MEMD, MIT, MAAIF, NFA	6.3.1	Promote integrated development of eco-tourism facilities	Protected areas of Aswa (in Pager Matidi sub-catchment)	Number of documents issued, by type, Number of eco-tourism facilities realized	1	6	19	26	21

PROGRAMME 7: Multipurpose Water Storage Facilities Programme Leader: Multipurpose Programme Unit (to be established under MWE)

Define and operationalise a Technical Standard for design, implementation and management of multipurpose water for production storage facilities, storage facilities including recreational functions and including hydropower. Establish a responsible authority for multipurpose storages integrated planning and coordination at catchment level (e.g. institutional authority which manage priority of dam's implementation); establish a responsible authority for multipurpose storage which manage and is responsible for balancing competing demands (e.g. institutional authority); establish a team responsible for efficient operation and management of multipurpose dam (e.g. technical staff, O&M guidelines).

Support Institutions	Action ID	Action to be implemented	Priority Area	Indicator	2017-2020 (US\$ '000)	2020-2025 (US\$ '000)	2025-2040 (US\$ '000)	Total Cost (US\$ '000)	Total Cost for Implementation ONLY in Priority Area (US\$'000)
DWRM, WSDF, TSU, UO, Districts	2.3.2	Increased water storage capacity for domestic water supply in areas with seasonal deficits	Water storages to supply water to Kitgum town and towns in Pader district	Number of water storage planned and constructed (type, capacity, Number of population served)	69	850	2,551	3,471	2,603
DWRM, WSDF, TSU, UO, Districts	2.3.3	Develop bulk diversion schemes for water supply in areas with water deficit	Adduction linked to water storages to supply water to Gulu, Arua and Koboko towns	Number of water transfer schemes planned (type, capacity, Number of population served)	90	1,104	3,312	4,506	3,380
DWRM, MAAIF, MEMD, MIT, OPM	4.3.3.A	Increase water for production storage capacity (large multipurpose storages)	Nyimur and Moroto multipurpose projects	Number of WFP large storage built (type, capacity, location, water source, use)	526	6,449	19,347	26,323	26,323

PROGRAMME 8: Integrated Water and Land Management		Promote water efficiency practices (water conservation, reuse, recycling) in the Aswa Catchment, promote irrigation water efficiency and water conservation agricultural practices, and promote optimization of water for production uses and reuse of treated wastewater for landscaping, green areas and other uses. Ensure appropriate environmental flows in water bodies, establish and maintain a water demand management system, promote integrated land and water management and enforce riverbanks protection zones. Increase preparedness to severe climate events (flood / drought).							
Programme Leader: UN-WMZ									
Support Institutions	Action ID	Action to be implemented	Priority Area	Indicator	2017-2020 (US\$'000)	2020-2025 (US\$'000)	2025-2040 (US\$'000)	Total Cost (US\$'000)	Total Cost for Implementation ONLY in Priority Area (US\$'000)
SUB-PROGRAMME: Water Efficiency Sub-Programme Leader: UN-WMZ									
DWD, DEA, NEMA, NFA	2.4.1 3.2.1 4.2.1 5.2.1 6.2.1	Promote water efficiency practices (water		Number of documents issued, by type	7	44	131	181	
DWD, DEA, NEMA, NFA	6.3.4	Promote the reuse of treated wastewater for irrigation of landscaping, green areas and other uses		Number of documents issued, by type	4	24	73	101	
SUB-PROGRAMME: Environmental Flows and Reserve Management System Sub-Programme Leader: UN-WMZ									
DWRM, DEA, CMO	1.2.3 2.2.2 4.2.2 5.2.2 6.3.2 7.4.1 8.2.1	Ensure appropriate environmental flows in water bodies		Number of documents issued, by type	19	113	339	471	
DWRM, DEA, CMO	1.4.6	Establish and maintain a water demand management system		Number of documents published, by type % coverage	2	10	29	40	

DWRM, DEA, CMO	1.4.7	Establish and maintain an environmental flow and reserve management system		Number of documents published, by type % coverage	2	14	41	56	
----------------	-------	--	--	---	---	----	----	----	--

SUB-PROGRAMME: Integrated Water and Land Management
Sub-Programme Leader: DEA

NEMA, NFA	1.2.4 4.4.2 8.4.3 9.4.1	Promote integrated land and water management		Number of documents issued, by type	36	214	642	891	
-----------	----------------------------------	--	--	-------------------------------------	----	-----	-----	-----	--

NEMA, NFA	8.3.1	Create a green infrastructure system to establish and protect ecologic corridors along water bodies	Upper part of Aswa, Agago and Pager (Kape-ta-Lakal-as- Kalimon) rivers	% of Catchment covered Area of green infrastructure created (by type, extension, water body, function)	422	2,534	7,603	10,559	7,392
-----------	-------	---	--	--	-----	-------	-------	--------	-------

NEMA, NFA	8.3.2	Create a green infrastructure system in the cattle corridor	Kaabong, Kitgum, Kotido and Abim districts	% of Catchment covered Area of green infrastructure created (by type, extension, cattle corridor area, use)	911	5,464	16,392	22,767	11,384
-----------	-------	---	--	---	-----	-------	--------	--------	--------

NEMA, NFA	8.4.2	Enforce river-banks protection zones	Upper part of Aswa River (Aswa I and II) and Agago River	Number of documents issued, by type, length of river banks protected	845	5,069	15,206	21,119	10,559
-----------	-------	--------------------------------------	--	--	-----	-------	--------	--------	--------

SUB-PROGRAMME: Resilience to Climate Variability and Change
Sub-Programme Leader: UN-WMZ

DWRM, DEA, NEMA, UCC, UNMA	9.2.1	Increase preparedness to severe climate events (flood / drought)		Number of flood area covered, by water body, Number of drought area covered, population covered	14	84	253	352	
----------------------------	-------	--	--	---	----	----	-----	-----	--

PROGRAMME 9: Stakeholder Engagement and Participatory IWRM Programme Leader: UN-WMZ

Stakeholder engagement mechanism developed and established at the WMZ/Catchment level. Awareness raising on wise use of water resource and on waste management. Awareness raising on water efficiency in agriculture, on water efficiency in industry, on renewable energy potential and energy efficiency, on water for environment and management of natural resources.

Support Institutions	Action ID	Action to be implemented	Priority Area	Indicator	2017-2020 (US\$ '000)	2020-2025 (US\$ '000)	2025-2040 (US\$ '000)	Total Cost (US\$ '000)	Total Cost for Implementation ONLY in Priority Area (US\$'000)
----------------------	-----------	--------------------------	---------------	-----------	-----------------------	-----------------------	-----------------------	------------------------	--

SUB-PROGRAMME: Stakeholder Engagement and Participatory IWRM Sub-Programme Leader: UN-WMZ

CMO, Districts	1.5.1	Develop and implement a stakeholder engagement mechanism		Number of stakeholder engagement activities planned	4	24	73	101	
DWRM, CMO, Districts	1.5.4	Promote trans-boundary cooperation on IWRM		Number of events planned and organized Number of participants	5	31	94	130	

SUB-PROGRAMME: Awareness Raising Sub-Programme Leader: UN-WMZ

DWRM, DWD, DEA, CMO	2.5.1	Awareness raising on wise use of water resources		Number of awareness raising activities planned Number of communication materials produced	4	24	73	101	
DWRM, DWD, DEA, CMO	3.5.1	Awareness raising on wastewater, faecal sludge and waste management		Number of awareness raising activities planned Number of communication materials produced	4	24	73	101	

DWRM, DWD, DEA, CMO	4.5.1	Awareness raising on water efficiency in agriculture		Number of awareness raising activities planned Number of communication materials produced	4	24	73	101	
DWRM, DWD, DEA, CMO	5.5.1	Awareness raising on water efficiency in industry		Number of awareness raising activities planned Number of communication materials produced	2	12	35	48	
DWRM, DWD, DEA, CMO	6.5.1	Awareness raising on water efficiency in tourism and other sectors		Number of awareness raising activities planned Number of communication materials produced	2	10	29	40	
DWRM, DWD, DEA, CMO	7.5.1	Awareness raising on renewable energy potential and energy efficiency		Number of awareness raising activities planned Number of communication materials produced	2	10	29	40	
DWRM, DWD, DEA, CMO	8.5.1 9.5.1	Awareness raising on water, environment and management of natural resources		Number of awareness raising activities planned Number of communication materials produced	8	48	145	202	

PROGRAMME 10: Technical Capacity Building
Programme Leader: DWRM

Training activities of Catchment/WMZ technical staff by Consultants (Hydraulic Engineer and/or hydrologist, Environmental expert, Institutional Representative), implementation of manuals, Capacity building organization and stakeholder engagement at local/community level, will be developed in 8 year. Two training activities and technical support to Catchment/WMZ staff are foreseen per year: 2 Consultants to assist 3 technical employees, duration of 20 hours. Total cost include also additional 10-15 hours of Catchment/WMZ staff to train, coordinate and assist stakeholders involved at local level (e.g. farmers, employees in industrial sectors, cattle farmers etc.). One Stakeholder meeting is foreseen, every two years. Total cost of multi-year Capacity Building Programme for technical evaluation of hydropower projects considers 3 training activities and technical support to Catchment/WMZ staff each lasting 20 hours and additional 20 hours of Catchment/WMZ staff to train technical employees of hydropower plants. During the first 4 year, one Stakeholder meeting is foreseen per year, then one stakeholder meeting every two years.

Support Institutions	Action ID	Action to be implemented	Priority Area	Indicator	2017-2020 (US\$ '000)	2020-2025 (US\$ '000)	2025-2040 (US\$ '000)	Total Cost (US\$ '000)	Total Cost for Implementation ONLY in Priority Area (US\$'000)
----------------------	-----------	--------------------------	---------------	-----------	-----------------------	-----------------------	-----------------------	------------------------	--

DWRM, MAAIF, MEMD, MIT, OPM	4.3.4	Develop bulk diversion schemes for water for production in areas with water deficit	Adduction linked to water storages (Nyimur and Moroto projects)	Number of water transfer schemes planned (by type, capacity, water source, use)	808	9,894	29,683	40,386	40,386
DWRM, DWD, DEA, OPM, WESWG, MEMD, MIT, MAAIF, NFA	6.3.3	Include recreational functions in the multipurpose water storages facilities development		Number of documents issued, by type	1	14	41	56	
DWRM, DWD, DEA, OPM, WESWG, MEMD, MIT, MAAIF, NFA	7.3.1	Develop adequate multipurpose water storage facilities including hydropower generation		Number of HPP planned and realized (by type, water body, capacity, use)	113	1,383	4,150	5,646	

WESWG, DWD, DEA, Upper Nile WMZ	1.5.2	Institutional Capacity Building at the local level, including local governments and urban authorities		Number of training activities planned % of Aswa Catchment covered Number of trained people	4	24	73	101	
WESWG, DWD, DEA, Upper Nile WMZ	1.5.3	Build technical capacity for implementation increased through specific training programmes, including GIS and modelling training and promotion of research and innovation to identify suitable technologies		Number of training activities planned Number of training manuals produced	4	24	73	101	
WESWG, DWD, DEA, Upper Nile WMZ	2.5.2	Build technical capacity for improving water supply services in rural areas		Number of training activities planned Number of training manuals produced	4	24	73	101	
WESWG, DWD, DEA, Upper Nile WMZ	3.5.2	Build technical capacity for improving sanitation and hygiene services in minor urban areas and rural areas		Number of training activities planned Number of training manuals produced	4	24	73	101	
WESWG, DWD, DEA, Upper Nile WMZ	3.5.3	Build technical capacity for integrated pollution prevention and control		Number of training activities planned Number of training manuals produced	4	24	73	101	

WESWG, DWD, DEA, Upper Nile WMZ	4.5.2	Build technical capacity for improving efficient use of water resources for production in agricultural sectors		Number of training activities planned Number of training manuals produced	4	24	73	101	
WESWG, DWD, DEA, Upper Nile WMZ	5.5.2	Build technical capacity for improving efficient use of water resources for production in industrial sectors		Number of training activities planned Number of training manuals produced	2	12	35	48	
WESWG, DWD, DEA, Upper Nile WMZ	7.5.2	Build technical capacity for full development of the hydropower potential		Number of training activities planned Number of training manuals produced	2	10	30	41	
WESWG, DWD, DEA, Upper Nile WMZ	8.5.2 9.5.2	Build technical capacity for wetland management	Sub-catchments with more wetland extension (Aswa I and Agago sub-catchments)	Number of training activities planned Number of training manuals produced % of Catchment covered	12	75	225	312	174
WESWG, DWD, DEA, Upper Nile WMZ	8.5.3	Build technical capacity for ecosystem assessment	In areas with PAs, wetlands and forests, especially Aswa I, Agago and Pager Matidi sub-catchments	Number of training activities planned Number of training manuals produced % of Catchment covered	4	24	73	101	81

WESWG, DWD, DEA, Upper Nile WMZ	8.5.4	Build technical capacity for deter- mining and implemen- ting envi- ronmental flows and water re- serves		Number of training activities planned Number of training manuals produced % of Catchment covered	5	31	94	130	
--	-------	--	--	--	---	----	----	-----	--